

# NITROGAS

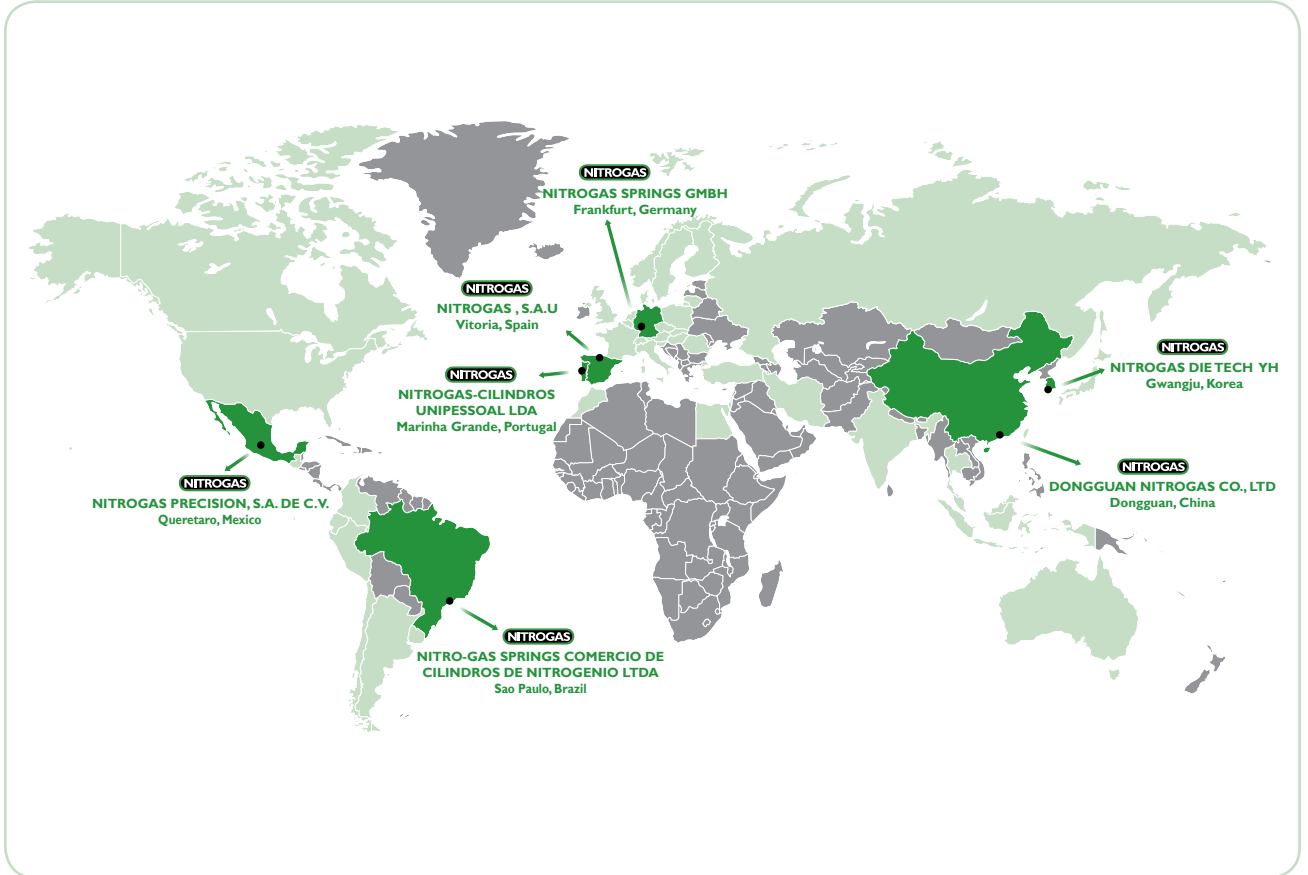

NITROGAS is a global company that has a worldwide presence through its own network of subsidiaries and extensive distributor network.

## SUBSIDIARIES



## DISTRIBUTORS

### WESTERN EUROPE

Austria	Italy	Sweden
Denmark	Netherlands	Switzerland
Finland	Norway	United Kingdom
France	Portugal	
Germany	Spain	

### EASTERN EUROPE

Slovakia	Hungary
Slovenia	Czech Republic
Lithuania	Poland
Romania	Turkey
Russia	

### AMERICA

Argentina	Guatemala
Brazil	Mexico
Canada	Peru
Chile	Uruguay
Colombia	USA
Ecuador	

### ASIA-OCEANIA

Australia	Japan
China	Korea
India	Malaysia
Indonesia	Russia
Iran	Taiwan
Israel	Thailand

### AFRICA

Morocco  
South Africa

Our customers can learn more about the nearest contact on our website:

[www.nitrogas.com/es/Worldwide.aspx](http://www.nitrogas.com/es/Worldwide.aspx)



# Why Nitrogas?

## BEST GAS SPRING IN THE MARKET

NITROGAS's gas springs offer the world's most advanced technology, guaranteeing longer gas spring life than other products on the market.

NITROGAS offers customers products that meet any test of approval, confirming the longest life of our gas springs.



## 25 YEARS OF EXPERIENCE SPEAKS FOR ITSELF



NITROGAS was founded in Vitoria (Spain) in 1988 and has become one of the most important manufacturers of gas cylinders.

For 25 years we have developed this technology.

Today, NITROGAS has his wholly owned subsidiaries in Germany, Portugal, China, Korea, Mexico and Brazil besides its dealer network.

## ENGINEERS TO THE SERVICE OF TECHNICAL DEPARTMENTS

NITROGAS ensures maximum technical support to its customers, with prompt response to any application assistance or questions related to their products.



## TECHNOLOGICAL PARTNERS – SPECIFIC SOLUTIONS



NITROGAS created the NITROGAS TECHNOLOGY CENTER (NTC), bringing together a group of engineers and technicians to concentrate on the R & D services the company gives to customers with specific projects that may require special solutions or need higher performance than other standard products on the market.

## WORLD PRESENCE – PLANT SUPPORT (STOCK, REPAIRS...)

NITROGAS analyzes and diagnoses with its customers any product and service needs required in each customers' facility, formulating a response that meets customer expectations.

NITROGAS structure allows reaching any market in the world.



# Nitrogas Technology Center



NITROGAS is a company strongly committed to research and innovation. It has the largest Research and Knowledge Center in the world concerning gas springs: NITROGAS TECHNOLOGY CENTER.

Here a team of experienced engineers investigate and test the latest improvements and technologies related to the development of gas springs. As a result of hard work, several worldwide patents were obtained, and allow NITROGAS to remain leader in the development of new products, offering high tech solutions. NITROGAS also provides solutions to special request, or response to any question, problem or need of our customer.

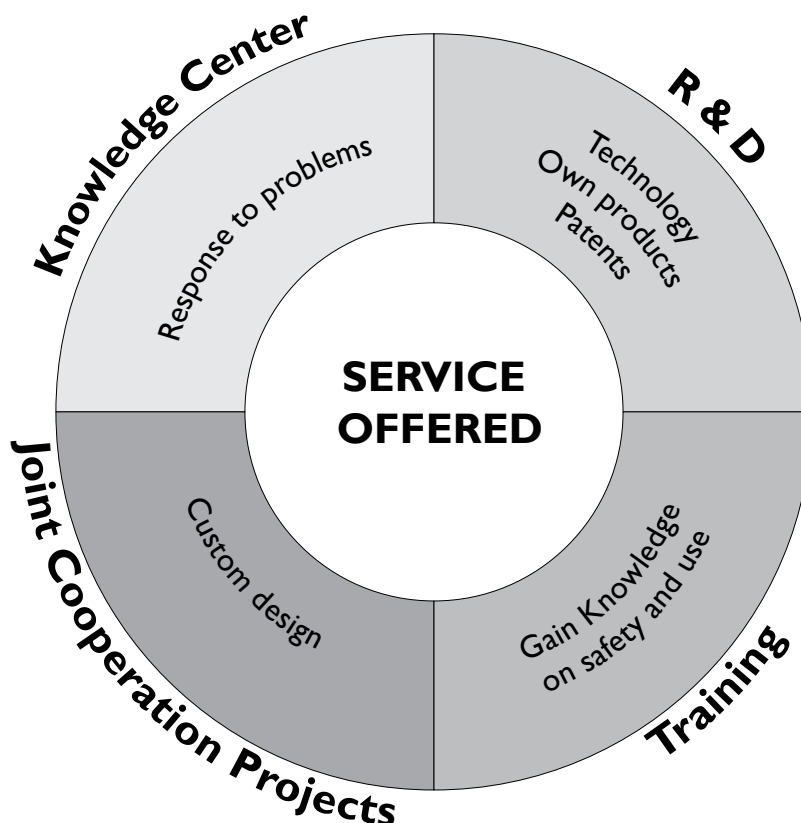



## TECHNICAL INFORMATION 2

Quality and Safety	2
Total Security	3
Technical Features	4
Safety Standards	6
Specifications for Installation and Use	8
Maintenance Recommendations	10

## GAS SPRINGS 12

Gas Spring Selection Guide	12
Gas Spring Overview	14
Diameter index	18
Force $\leq 100$ daN	22
Force 150 - 200 daN	32
Force 250 - 300 daN	44
Force 320 - 450 daN	54
Force 500 - 600 daN	68
Force 750 daN	86
Force 1000 daN	106
Force 1500 daN	128
Force 2500 daN	156
Force 3000 daN	170
Force 4000 daN	186
Force 5000 daN	200
Force 6500 daN	216
Force 7500 daN	228
Force 10000 daN	242
Force 12000 daN	255
Force 20000 daN	264

## EJECTOR PIN UNITS 278

## SPRING PLUNGERS 287

## ACCESSORIES 299



## Quality and Safety

Safety is a top priority for NITROGAS and we strongly believe that gas springs for metal stamping should meet some basic safety requirements.

Having always in mind our mission to satisfy our customers, NITROGAS was awarded in 1998 with the certification by Bureau Veritas in accordance with the requirement of the management system standards of ISO 9001:2000 Norm. This certification has been renewed in 2016 and is valid until 2018.



### PED

NITROGAS is also certified by the Pressure Equipment Directive 97/23/CE Directive that regulates the proper manufacturing of pressure equipment.

## Automotive Standards

Supplementary to the standards mentioned above, NITROGAS products also meet other automotive standards. If any standard-icon is showed, the gas springs's body and rod are designed to keep the dimensions that are established in this standard.

### ISO : ISO 11901



- ISO 11901-1 - Tools for pressing. Gas Springs. General specifications.
- ISO 11901-2 - Tools for pressing. Gas Springs. Specification of accessories.
- ISO 11901-3 - Tools for pressing. Gas Springs. Gas spring with increased spring force and compact built height.
- ISO 11901-4 - Tools for pressing. Gas Springs. Gas springs with increased spring force and same built height.



### VDI : Verein Deutscher Ingenieure

- VDI 3003 - Nitrogen gas springs in large stamping dies and mounting versions.
- VDI 3004 - Forcing pins with helical compression springs or nitrogen gas springs.

CNOMO  
EM24.54.700

### CNOMO : Renault Group

CNOMO EM24.54.700 - Gas springs, pneumatic springs for press tooling.

PSA  
E24.54.815.G

### PSA : Peugeot - Citroën Group

PSA E24.54.815.G - Gas springs and accessories.

SMS DNH  
3203N

### TOYOTA

SMS DNH 3203 N - Toyota standard.



## Total Security

NITROGAS want to offer the safest product with the longest life. Below there are some of our improvements related to the design, use and management of the gas spring that would make the maintenance work easier.

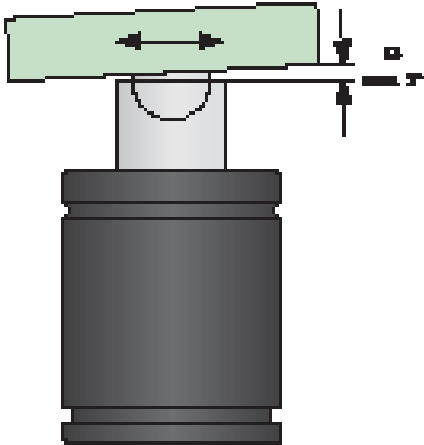

### ESK System PATENTED

Design for compensate unbalanced forces and increase gas springs life. This system allows up to two degrees of side load and unlike other balanced systems, the ESK system maintains the rod in vertical position.

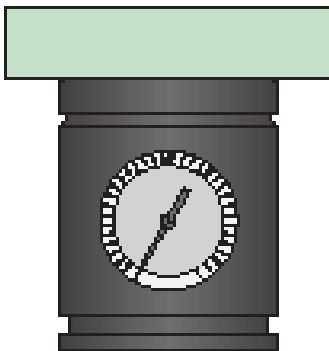

### Blow Out Protection System

Safety system that allows a controlled nitrogen gas discharge in case of overcome working limits.



### Excessive Return Speed Lifeguard

The new and safer design of the gas springs avoids the rupture in case of an excessively rapid return stroke.

## Technical Features

NITROGAS gas springs can be divided into Piston Rod Sealed gas springs or Bore Sealed gas springs depending on the type of seal and where it is located. The force of each gas spring depends on the nitrogen charging pressure and the working surface.

$$F \text{ (daN)} = P \text{ (bar)} \times S \text{ (mm}^2\text{)} / 100 \quad \text{where} \quad S = \pi \times d^2 / 4$$

### Piston Rod Sealed gas springs

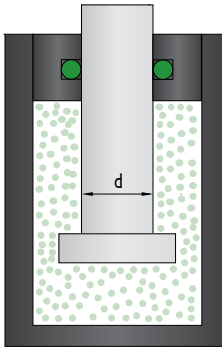

Piston rod gas springs suit a wide range of needs due to the high variety on their design.

To calculate the force of a piston rod sealed gas spring the diameter to take into account is the diameter of the rod.

Practical example using G-1500 gas spring:

$$\begin{aligned} d &= 36 \text{ mm} \\ P &= 150 \text{ bar} \\ S &= \pi \times 36^2 / 4 = 1018 \text{ mm}^2 \\ F &= 150 \times 1018 / 100 = 1527 \text{ daN} \end{aligned}$$

### Bore Sealed gas springs

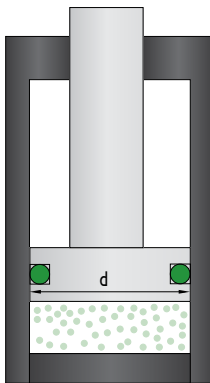

Bore sealed gas springs are ideal for small movements and very strong forces with a maximum contact pressure.

To calculate the force of a bore sealed gas spring the diameter to take into account is the diameter of the piston.

Practical example using TS-1800 gas spring:

$$\begin{aligned} d &= 40 \text{ mm} \\ P &= 145 \text{ bar} \\ S &= \pi \times 40^2 / 4 = 1257 \text{ mm}^2 \\ F &= 145 \times 1257 / 100 = 1822 \text{ daN} \end{aligned}$$





## Safety Standards

The gas springs contain high pressure gas. The rules detailed below are mandatory.



Any unauthorized operation performed, or improper use can cause serious material or personal injury. If there is any suspicion of damage to the gas spring, immediately remove it.

NITROGAS is not responsible for personal injury and damage that may happen because of violation of such security rules.

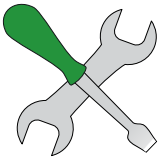

- 1 Maintenance must be performed exclusively by personal that has been trained and certified by NITROGAS. Any improper handling could cause serious safety hazards or limit the lifetime of the gas springs.  
Before any repair, discharge the pressure and ensure that the rod is completely within the body.

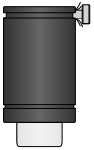

- 2 During discharge of the gas spring, orientate the gas flow in the opposite direction to the operator and position the discharge point as high as possible.  
We recommend the use of eyewear.



- 3 Gas springs must only be charged with commercial nitrogen.  
The maximum charge pressure (at 20 °C) is marked on each gas spring. Do not exceed the maximum charge pressure without the prior written consent of NITROGAS.

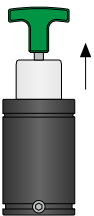

- 4 Before loading any gas spring, ensure that the piston rod is in its most extended position and the safety ring (in case any) is perfectly located in the housing.

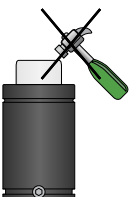

- 5 To test the force of a gas spring, there are specific tools for measurement to be used. Never hit on the rod to see if the gas spring is under pressure.





- 6 We recommend a regular visual inspection of the gas springs.  
If a gas spring has damage to its structure, discharge the pressure prior to review.

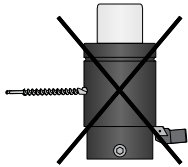

- 7 Any secondary operation (including grinding, machining, or welding) on any part of the gas spring is completely forbidden.  
The risks increase if operations are performed with a loaded gas spring.

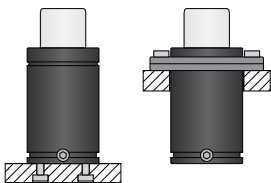

- 8 Gas springs must only be installed in the tool in the ways described in the specification sheet for each model.  
The gas springs shall be securely held in place by the thread of the bottom of the body or by fastening accessories NITROGAS offers in each model.

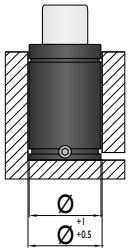

- 9 In the case of accommodating the gas spring in a pocket drilled in the tool, the body must be adjusted to the hole to prevent from pitching.  
If the gas spring is housed in a pocket that can be flooded, please allow for drainage to facilitate the outlet of fluids.

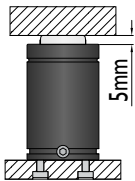

- 10 Avoid using the last 5 mm of the gas spring stroke to prevent possible over-stroke caused by changes or errors in the tool.  
An excessive stroke can have serious and obvious security risks that can cause permanent damage to the gas spring.

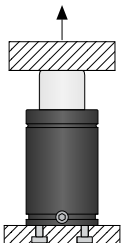

- 11 Prevent the sudden or uncontrolled rod output. Do not exceed the maximum speed specified in the file for each model.

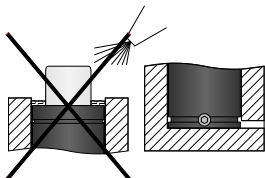

- 12 Protect the gas springs from direct contact with liquids or solids contaminations. If the gas cylinder is housed in a pocket that can be flooded, include drains to facilitate any outlet of fluids. In the case of fluids, the body should protrude 5 mm from surface to prevent fluids accumulation.

## Specifications for Installation and Use



For proper operation, gas springs must be installed following the specifications for installation and use described below.

NITROGAS is not liable for damages or premature wear caused to gas springs, due to failure to comply with these specifications for installation and use.

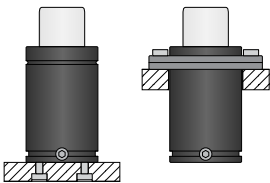

- 1 Install gas springs in the tool only in the ways described in the specification sheet for each model.

Gas springs must be securely fastened by the threads of the bottom of the body or by fastening the accessories NITROGAS offers for each model.

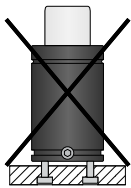

- 2 Check that the length of the fastening screw used is adequate so that the settlement of the gas spring is always on its base.

Tighten the clamping screws holding the base of the cylinder to the recommended torque:

M6 = 10Nm, M8 = 24Nm, M10 = 45Nm, M12 = 80Nm.

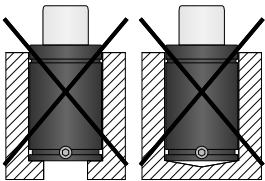

- 3 The base of the gas spring must rest on a plane support. Inadequate housing can damage the gas spring or reduce its life.

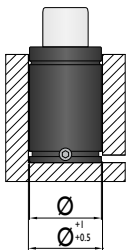

- 4 In case of accommodating the gas spring in a drilled pocket in the tool, the body must be adjusted to the hole to prevent from pitching.

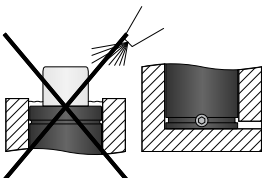

- 5 Protect gas springs from liquid or solid contamination. If the gas spring is housed in a pocket that can be flooded, include drains to facilitate any fluid outlet. In the case of fluids, the body should protrude 5 mm from surface to prevent fluids accumulation.

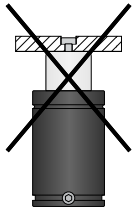

- 6 Do not use the threaded holes in the rod end to fix the gas spring to the tool.  
This hole is only intended for maintenance. Do not use for transport operations of gas springs.

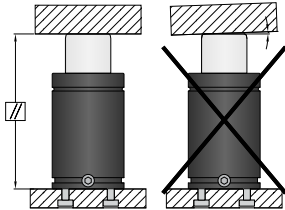

- 7 Ensure parallelism between the surface of the gas spring and the rod pushing surface to prevent the occurrence of lateral forces. The hardness of the contact surface should be sufficient. Ensure full contact on the bearing surface of the rod.

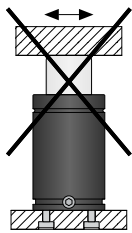

- 8 Avoid any lateral displacement of the gas spring while running. Give special attention to any vibrations during movement of the rod.

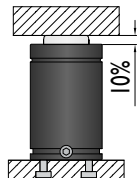

- 9 It is recommended to provide a reserve of travel at least 10% of the nominal stroke. The recommended reserve of travel for each gas spring is indicated in the specification sheet for each model.

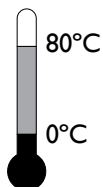

- 10 The operating temperature of the gas springs is between 0 °C and 80 °C. Upon request NITROGAS can supply gas springs supporting temperatures between - 20 °C and 180 °C.

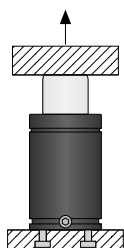

- 11 Prevent the sudden or uncontrolled rod output. Do not exceed the maximum speed specified in the file for each model.

## Maintenance Recommendations



Maintenance must be carried out exclusively by personal that has been trained and certified by NITROGAS. Any improper handling could cause serious safety hazards or limit the lifetime of the gas springs.



- 1 Before any repair, discharge entirely the pressure and ensure that the rod is completely within the body.

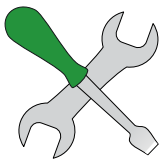

- 2 We recommend a regular visual inspection of the gas springs. If a cylinder has damage to its structure, fully discharge the pressure prior to review.



- 3 During unloading of the gas spring, direct the flow of gas away from the operator and position the discharge point as high as possible. We recommend using safety glasses.



- 4 Never throw away the gas spring without having properly discharged the pressure.



- 5 Gas springs must be loaded with commercial nitrogen. The maximum loading pressure (at 20 °C) is marked on each gas spring. Do not exceed the maximum charge pressure without the prior written consent of NITROGAS.

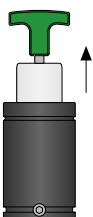

- 6 Before loading any gas spring, make sure that the rod is in its most extended position and the safety ring (in case any) is perfectly located in the housing.



- 7 To test the strength of a specific cylinder there are specific tools for measuring the force. Never hit the rod to see if the gas spring is under pressure.

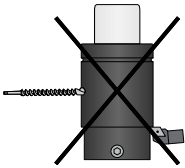

- 8 To ensure correct operation of the gas spring, the surfaces of the rod and body of the gas spring must remain free of blows, scratches, or any type of deformation.  
The secondary operations of any part of the gas spring (including grinding, machining, welding, etc.) are completely forbidden.









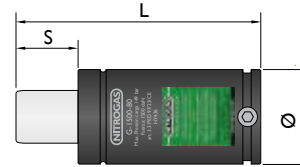



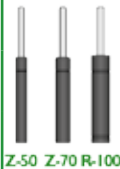

- 9 Protect gas springs during transportation. Protect gas springs from hitting each other; protect them from oxidation in the case of maritime transport.

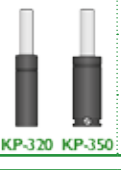





















## Gas Spring Selection Guide



Gas spring family

Force daN	MICRO	LOW PROFILE HIGH FORCE	KH	HD	STANDARD	COMPACT	Model	max F0	Ø mm	S mm	L mm		Linkable
≤ 100	 Z-50 Z-70 R-100						Z-50	13 - 50	12	7 - 125	2xS + 42	No	No
							Z-70	18 - 70	15	7 - 125	2xS + 42	No	No
							R-100	30 - 90	19	7 - 125	2xS + 42	No	No
150 - 200	 R-200	 KP-150			 CN-150		KP-150	150	19	7 - 125	2xS + 30	No	No
							R-200	50 - 200	25	10 - 125	2xS + 42	No	No
							CN-150	150	32	10 - 125	2xS + 50	No	No
250					 CN-250		CN-250	265	38	10 - 125	2xS + 50	No	M6
320 - 450	 KP-320 KP-350					 TS-420	KP-320	320	25	7 - 125	2xS + 30	No	No
							KP-350	360	32	10 - 125	2xS + 30	No	M6
							TS-420	420	25	6 - 50	56 - 195	No	No
500	 KP-500	 KH-500			 CN-500		KP-500	470	38	10 - 125	2xS + 30	No	M6
							KH-500	470	45	12.7 - 125	2xS + 50	No	G1/8"
							CN-500	470	45	12.7 - 160	2xS + 85	No	G1/8"
750	 KP-750 KH-750 HD-750 G-750 TS-750						KP-750	740	45	10 - 125	2xS + 32	Yes	M6
							KH-750	740	50	12.7 - 125	2xS + 50	Yes	G1/8"
							HD-750	740	45	13 - 200	2xS + 85	Yes	G1/8"
							G-750	740	50	12.7 - 300	2xS + 95	Yes	G1/8"
							TS-750	740	32	6 - 50	63 - 195	No	No
1000	 KP-1000 HD-1000 TS-1000						KP-1000	920	50	13 - 125	2xS + 38	Yes	M6
							HD-1000	920	50	25 - 300	2xS + 95	Yes	G1/8"
							TS-1000	920	38	6 - 50	61 - 230	No	No
1500	 KP-1500 KH-1500 HD-1500 G-1500 TS-1800						KP-1500	1500	63	13 - 125	2xS + 44	Yes	M6
							KH-1500	1500	75	25 - 125	2xS + 60	Yes	G1/8"
							HD-1500	1500	63	25 - 300	2xS + 95	Yes	G1/8"
							G-1500	1500	75	25 - 300	2xS + 110	Yes	G1/8"
							TS-1800	1800	50	6 - 65	66 - 271	No	No

## Gas spring family

Force	LOW PROFILE HIGH FORCE	KH	HD	STANDARD	COMPACT	Model	max F0	Ø mm	S mm	L mm		Linkable
2500						KP-2400	2400	75	16 - 125	2xS + 45	Yes	M6
						HD-2400	2400	75	25 - 300	2xS + 110	Yes	G1/8"
3000						G-3000	3000	95	25 - 300	2xS + 120	Yes	G1/8"
						TS-3000	3000	63	10 - 65	85 - 256	No	No
4000						KP-4200	4200	95	16 - 125	2xS + 58	Yes	G1/8"
						HD-4200	4200	95	25 - 300	2xS + 120	Yes	G1/8"
5000						G-5000	5000	120	25 - 300	2xS + 140	Yes	G1/8"
						TS-4700	4700	75	10 - 65	80 - 273	No	No
6500						KP-6600	6600	120	16 - 125	2xS + 68	Yes	G1/8"
						HD-6600	6600	120	25 - 300	2xS + 140	Yes	G1/8"
7500						CN-7500	7500	150	25 - 300	2xS + 155	Yes	G1/8"
						TS-7500	7500	95	10 - 65	90 - 279	No	No
10000						KP-9500	9500	150	19 - 125	2xS + 78	Yes	G1/8"
						HD-9500	9500	150	25 - 200	2xS + 155	Yes	G1/8"
						CN-10000	10600	195	25 - 300	2xS + 160	Yes	G1/8"
12000						TS-11800	11800	120	10 - 65	100 - 320	No	No
20000						KP-20000	20000	195	19 - 125	2xS + 110	No	G1/8"
						HD-20000	20000	195	25 - 300	2xS + 160	No	G1/8"
						TS-18300	18300	150	10 - 65	110 - 323	No	No

## Gas Spring Overview

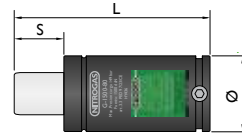

### Micro

Gas springs with reduced dimensions and colour coded for easy identification.

R	F <sub>0</sub> daN	Ø mm	L mm	STROKE																								
				6	7	10	12	13	15	16	19	20	25	30	32	38	40	50	60	63	75	80	100	125	160	200	250	300
R-100	30-90	19	2xS+42	*	*			*					*			*	*	*	*	*	*	*	*	*	*	*	*	
R-200	50-200	25	2xS+42		*		*	*	*	*			*			*	*	*	*	*	*	*	*	*	*	*	*	*

Z	F <sub>0</sub> daN	Ø mm	L mm	STROKE																								
				6	7	10	12	13	15	16	19	20	25	30	32	38	40	50	60	63	75	80	100	125	160	200	250	300
Z-50	13-50	12	2xS+42	*	*		*	*	*	*			*			*	*	*	*	*	*	*	*	*	*	*	*	*
Z-70	18-70	15	2xS+42	*	*		*	*	*	*			*			*	*	*	*	*	*	*	*	*	*	*	*	*

### ISO

Designed to keep the dimensions established in the ISO 11901-I standard.

CN	F <sub>0</sub> daN	Ø mm	L mm	STROKE																							
				6	7	10	12	13	15	16	19	20	25	30	32	38	40	50	60	63	75	80	100	125	160	200	250
CN-150	150	32	2xS+50		*		*			*			*			*	*	*	*	*	*	*	*	*	*	*	*
CN-250	265	38	2xS+50		*		*			*	*		*			*	*	*	*	*	*	*	*	*	*	*	*
CN-500	470	45	2xS+85				*			*			*			*	*	*	*	*	*	*	*	*	*	*	*
CN-7500	7500	150	2xS+155							*			*			*	*	*	*	*	*	*	*	*	*	*	*
CN-10000	10600	195	2xS+160							*			*			*	*	*	*	*	*	*	*	*	*	*	*

G	F <sub>0</sub> daN	Ø mm	L mm	STROKE																							
				6	7	10	12	13	15	16	19	20	25	30	32	38	40	50	60	63	75	80	100	125	160	200	250
G-750	740	50	2xS+95					*				*			*	*	*	*	*	*	*	*	*	*	*	*	*
G-1500	1500	75	2xS+110							*			*			*	*	*	*	*	*	*	*	*	*	*	*
G-3000	3000	95	2xS+120							*			*			*	*	*	*	*	*	*	*	*	*	*	*
G-5000	5000	120	2xS+140							*			*			*	*	*	*	*	*	*	*	*	*	*	*

### Low profile - High Force

Maximum force with the minimum height.

K	F <sub>0</sub> daN	Ø mm	L mm	STROKE																							
				6	7	10	12	13	15	16	19	20	25	30	32	38	40	50	60	63	75	80	100	125	160	200	250
K-200	50-200	25	2xS+32	*	*			*				*			*	*	*	*	*	*	*	*	*	*	*	*	*
K-300	100-300	32	2xS+39	*	*			*				*			*	*	*	*	*	*	*	*	*	*	*	*	*
K-570	570	38	2xS+37	*	*			*				*			*	*	*	*	*	*	*	*	*	*	*	*	*
K-750	740	45	2xS+50				*			*			*			*	*	*	*	*	*	*	*	*	*	*	*
K-1000	990	50	2xS+50				*			*			*			*	*	*	*	*	*	*	*	*	*	*	*
K-1500	1500	63	2xS+60				*			*			*			*	*	*	*	*	*	*	*	*	*	*	*
K-2500	2500	75	2xS+60				*			*			*			*	*	*	*	*	*	*	*	*	*	*	*
K-4000	4000	95	2xS+70							*			*			*	*	*	*	*	*	*	*	*	*	*	*

KC	F <sub>0</sub> daN	Ø mm	L mm	STROKE																										
				6	7	10	12	13	15	16	19	20	25	30	32	38	40	50	60	63	75	80	100	125	160	200	250	300		
KC-300	300	32	2xS+37	*	*				*		*		*		*		*		*		*		*		*		*			
KC-550	550	38	2xS+32				*				*		*		*		*		*		*		*		*		*			
KC-1500	1500	63	2xS+52				*				*		*		*		*		*		*		*		*		*			
KC-3000	3000	75	2xS+54				*				*		*		*		*		*		*		*		*		*			
KC-5000	5000	105	2xS+60				*				*		*		*		*		*		*		*		*		*			

KH	F <sub>0</sub> daN	Ø mm	L mm	STROKE																										
				6	7	10	12	13	15	16	19	20	25	30	32	38	40	50	60	63	75	80	100	125	160	200	250	300		
KH-500	470	45	2xS+50					*		*		*		*		*		*		*		*		*		*		*		
KH-750	740	50	2xS+50				*			*		*		*		*		*		*		*		*		*		*		
KH-1500	1500	75	2xS+60								*		*		*		*		*		*		*		*		*		*	

KP	F <sub>0</sub> daN	Ø mm	L mm	STROKE																										
				6	7	10	12	13	15	16	19	20	25	30	32	38	40	50	60	63	75	80	100	125	160	200	250	300		
KP-150	150	19	2xS+30	*	*			*		*		*		*		*		*		*		*		*		*		*		
KP-320	320	25	2xS+30	*	*			*		*		*		*		*		*		*		*		*		*		*		
KP-350	360	32	2xS+30	*	*		*		*		*		*		*		*		*		*		*		*		*		*	
KP-500	470	38	2xS+30	*	*		*		*		*		*		*		*		*		*		*		*		*		*	
KP-750	740	45	2xS+32	*	*		*		*		*		*		*		*		*		*		*		*		*		*	
KP-1000	920	50	2xS+38				*		*		*		*		*		*		*		*		*		*		*		*	
KP-1500	1500	63	2xS+44				*		*		*		*		*		*		*		*		*		*		*		*	
KP-2400	2400	75	2xS+45					*	*		*		*		*		*		*		*		*		*		*		*	
KP-4200	4200	95	2xS+58					*	*		*		*		*		*		*		*		*		*		*		*	
KP-6600	6600	120	2xS+68					*	*		*		*		*		*		*		*		*		*		*		*	
KP-9500	9500	150	2xS+78					*	*		*		*		*		*		*		*		*		*		*		*	
KP-20000	20000	195	2xS+110					*	*		*		*		*		*		*		*		*		*		*		*	

NR	F <sub>0</sub> daN	Ø mm	L mm	STROKE																										
				6	7	10	12	13	15	16	19	20	25	30	32	38	40	50	60	63	75	80	100	125	160	200	250	300		
NR-350	360	32	2xS+40		*		*		*		*		*		*		*		*		*		*		*		*		*	
NR-500	470	38	2xS+40		*		*		*		*		*		*		*		*		*		*		*		*		*	
NR-750	740	45	2xS+47		*		*		*		*		*		*		*		*		*		*		*		*		*	
NR-1000	920	50	2xS+52				*		*		*		*		*		*		*		*		*		*		*		*	
NR-1500	1500	63	2xS+52				*		*		*		*		*		*		*		*		*		*		*		*	
NR-2400	2400	75	2xS+59				*		*		*		*		*		*		*		*		*		*		*		*	
NR-4200	4200	95	2xS+62				*		*		*		*		*		*		*		*		*		*		*		*	
NR-6600	6600	120	2xS+72				*		*		*		*		*		*		*		*		*		*		*		*	

NT	F <sub>0</sub> daN	Ø mm	L mm	STROKE																										
				6	7	10	12	13	15	16	19	20	25	30	32	38	40	50	60	63	75	80	100	125	160	200	250	300		
NT-1000	920	50	2xS+52				*		*		*		*		*		*		*		*		*		*		*		*	
NT-2400	2400	75	2xS+59				*		*		*		*		*		*		*		*		*		*		*		*	
NT-4200	4200	95	2xS+62				*		*		*		*		*		*		*		*		*		*		*		*	
NT-6600	6600	120	2xS+72				*		*		*		*		*		*		*		*		*		*		*		*	
NT-9500	9500	150	2xS+78				*		*		*		*		*		*		*		*		*		*		*		*	



## Standard Dimensions

Designed based on ISO 11901-I standard to provide more force with a similar height.

G	F <sub>0</sub> daN	Ø mm	L mm	STROKE																							
				6	7	10	12	13	15	16	19	20	25	30	32	38	40	50	60	63	75	80	100	125	160	200	250
<b>G-100</b>	30-90	22	2xS+60				*								*		*	*	*	*	*	*	*				
<b>G-200</b>	50-200	25	2xS+54				*								*		*	*	*	*	*	*	*				
<b>G-300</b>	100-300	32	2xS+60				*								*		*	*	*	*	*	*	*				
<b>G-500</b>	500	45	2xS+60				*								*		*	*	*	*	*	*	*				
<b>G-10000</b>	9500	150	2xS+136												*		*	*	*	*	*	*	*	*	*	*	*

HD	F <sub>0</sub> daN	Ø mm	L mm	STROKE																							
				6	7	10	12	13	15	16	19	20	25	30	32	38	40	50	60	63	75	80	100	125	160	200	250
<b>HD-750</b>	740	45	2xS+85					*							*		*	*	*	*	*	*	*	*	*	*	*
<b>HD-1000</b>	920	50	2xS+95												*		*	*	*	*	*	*	*	*	*	*	*
<b>HD-1500</b>	1500	63	2xS+95												*		*	*	*	*	*	*	*	*	*	*	*
<b>HD-2400</b>	2400	75	2xS+110												*		*	*	*	*	*	*	*	*	*	*	*
<b>HD-4200</b>	4200	95	2xS+120												*		*	*	*	*	*	*	*	*	*	*	*
<b>HD-6600</b>	6600	120	2xS+140												*		*	*	*	*	*	*	*	*	*	*	*
<b>HD-9500</b>	9500	150	2xS+155												*		*	*	*	*	*	*	*	*	*	*	*
<b>HD-20000</b>	20000	195	2xS+160												*		*	*	*	*	*	*	*	*	*	*	*

HG	F <sub>0</sub> daN	Ø mm	L mm	STROKE																							
				6	7	10	12	13	15	16	19	20	25	30	32	38	40	50	60	63	75	80	100	125	160	200	250
<b>HG-750</b>	740	50	2xS+70					*							*		*	*	*	*	*	*	*	*	*	*	*
<b>HG-1500</b>	1500	75	2xS+85												*		*	*	*	*	*	*	*	*	*	*	*
<b>HG-3000</b>	3000	95	2xS+95												*		*	*	*	*	*	*	*	*	*	*	*
<b>HG-5000</b>	5000	120	2xS+102.5												*		*	*	*	*	*	*	*	*	*	*	*
<b>HG-7500</b>	7500	150	2xS+105												*		*	*	*	*	*	*	*	*	*	*	*

M	F <sub>0</sub> daN	Ø mm	L mm	STROKE																							
				6	7	10	12	13	15	16	19	20	25	30	32	38	40	50	60	63	75	80	100	125	160	200	250
<b>M-350</b>	350	32	2xS+50							*					*		*	*	*	*	*	*	*	*	*	*	*
<b>M-500</b>	500	38	2xS+55				*		*						*		*	*	*	*	*	*	*	*	*	*	*
<b>M-1000</b>	920	50	2xS+85												*		*	*	*	*	*	*	*	*	*	*	*
<b>M-1500</b>	1500	63	2xS+85												*		*	*	*	*	*	*	*	*	*	*	*
<b>M-2500</b>	2500	75	2xS+95												*		*	*	*	*	*	*	*	*	*	*	*
<b>M-4000</b>	4000	95	2xS+110												*		*	*	*	*	*	*	*	*	*	*	*
<b>M-6500</b>	6400	120	2xS+115												*		*	*	*	*	*	*	*	*	*	*	*

## Compact

Bore sealed gas springs provide extreme forces with minimal body diameters and short strokes.

T	F <sub>0</sub> daN	Ø mm	L mm	STROKE																										
				6	7	10	12	13	15	16	19	20	25	30	32	38	40	50	60	65	75	80	100	125	160	200	250	300		
T-420	420	25	56-195	*	*					*		*		*		*		*		*		*		*		*		*		
T-750	740	32	63-195	*	*					*		*		*		*		*		*		*		*		*		*		
T-1000	920	38	61-230	*	*					*		*		*		*		*		*		*		*		*		*		
T-1800	1800	50	66-220	*	*					*		*		*		*		*		*		*		*		*		*		
T-3000	3000	63	85-205			*				*		*		*		*		*		*		*		*		*		*		
T-4700	4700	75	80-240			*				*		*		*		*		*		*		*		*		*		*		
T-7500	7500	95	90-255			*				*		*		*		*		*		*		*		*		*		*		
T-11800	11800	120	100-260			*				*		*		*		*		*		*		*		*		*		*		
T-18300	18300	150	110-270			*				*		*		*		*		*		*		*		*		*		*		

TS	F <sub>0</sub> daN	Ø mm	L mm	STROKE																										
				6	7	10	12	13	15	16	19	20	25	30	32	38	40	50	60	65	75	80	100	125	160	200	250	300		
TS-420	420	25	56-195	*	*					*		*		*		*		*		*		*		*		*		*		
TS-750	740	32	63-195	*	*					*		*		*		*		*		*		*		*		*		*		
TS-1000	920	38	61-230	*	*					*		*		*		*		*		*		*		*		*		*		
TS-1800	1800	50	66-271	*	*					*		*		*		*		*		*		*		*		*		*		
TS-3000	3000	63	85-256			*				*		*		*		*		*		*		*		*		*		*		
TS-4700	4700	75	80-273			*				*		*		*		*		*		*		*		*		*		*		
TS-7500	7500	95	90-279			*				*		*		*		*		*		*		*		*		*		*		
TS-11800	11800	120	100-320			*				*		*		*		*		*		*		*		*		*		*		
TS-18300	18300	150	110-323			*				*		*		*		*		*		*		*		*		*		*		

Connectable options available with TC and TCS gas springs.





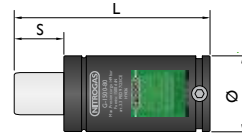

## Diameter index



Model	max F <sub>0</sub>	Ø mm	S mm	L mm		Linkable	Page
Z-50	13 - 50	12	7 - 125	2xS + 42	No	No	24
Z-70	18 - 70	15	7 - 125	2xS + 42	No	No	26
R-100	30 - 90	19	7 - 125	2xS + 42	No	No	28
KP-150	150	19	7 - 125	2xS + 30	No	No	34
G-100	30-90	22	12 - 125	2xS + 60	No	No	30
K-200	50 - 200	25	7 - 125	2xS + 32	No	No	36
R-200	50 - 200	25	10 - 125	2xS + 42	No	No	38
G-200	50 - 200	25	12 - 125	2xS + 54	No	No	42
KP-320	320	25	7 - 125	2xS + 30	No	No	56
T-420	420	25	6 - 50	56 - 195	No	No	64
TS-420	420	25	6 - 50	56 - 195	No	No	66
CN-150	150	32	10 - 125	2xS + 50	No	No	40
KC-300	300	32	7 - 125	2xS + 37	No	No	46
K-300	100 - 300	32	7 - 125	2xS + 39	No	No	48
G-300	100 - 300	32	12 - 125	2xS + 60	No	No	52
M-350	350	32	15 - 125	2xS + 50	No	No	62
KP-350	360	32	10 - 125	2xS + 30	No	M6	58
NR-350	360	32	10 - 125	2xS + 40	No	M6	60
T-750	740	32	6 - 50	63 - 195	No	No	102
TS-750	740	32	6 - 50	63 - 195	No	No	104
CN-250	265	38	10 - 125	2xS + 50	No	M6	50
KP-500	470	38	10 - 125	2xS + 30	No	M6	70
NR-500	470	38	10 - 125	2xS + 40	No	G1/8"	76
M-500	500	38	12 - 125	2xS + 55	No	No	80
KC-550	550	38	12 - 125	2xS + 32	No	No	72
K-570	570	38	7 - 125	2xS + 37	No	No	74
T-1000	920	38	6 - 50	61 - 230	No	No	120
TS-1000	920	38	6 - 50	61 - 230	No	No	124
TC-1000	920	38	6 - 50	81 - 250	No	G1/8"	122
TSC-1000	920	38	6 - 50	81 - 250	No	G1/8"	126
KH-500	470	45	12.7 - 125	2xS + 50	No	G1/8"	78
CN-500	470	45	12.7 - 160	2xS + 85	No	G1/8"	84
G-500	500	45	12 - 125	2xS + 60	No	No	82
KP-750	740	45	10 - 125	2xS + 32	Yes	M6	88
NR-750	740	45	10 - 125	2xS + 47	Yes	M6	90
K-750	740	45	12 - 125	2xS + 50	Yes	G1/8"	92
HD-750	740	45	13 - 200	2xS + 85	Yes	G1/8"	98
KH-750	740	50	12.7 - 125	2xS + 50	Yes	G1/8"	94
HG-750	740	50	12.5 - 200	2xS + 70	Yes	G1/8"	96
G-750	740	50	12.7 - 300	2xS + 95	Yes	G1/8"	100
KP-1000	920	50	13-125	2xS + 38	Yes	M6	108
NR-1000	920	50	13-125	2xS + 52	Yes	G1/8"	112
NT-1000	920	50	13-125	2xS + 52	Yes	G1/8"	114
K-1000	990	50	13-125	2xS + 50	Yes	G1/8"	110
M-1000	920	50	25-160	2xS + 85	Yes	G1/8"	116

Model	max F <sub>0</sub>	Ø mm	S mm	L mm		Linkable	Page
HD-1000	920	50	25 - 300	2xS + 95	Yes	G1/8"	118
T-1800	1800	50	6 - 50	66 - 220	No	No	148
TS-1800	1800	50	6 - 65	66 - 271	No	No	152
TC-1800	1800	50	6 - 50	86 - 240	No	G1/8"	150
TSC-1800	1800	50	6 - 65	86 - 291	No	G1/8"	154
KP-1500	1500	63	13 - 125	2xS + 44	Yes	M6	130
KC-1500	1500	63	12 - 125	2xS + 52	Yes	M6	132
NR-1500	1500	63	13 - 125	2xS + 52	Yes	G1/8"	134
K-1500	1500	63	12 - 125	2xS + 60	Yes	G1/8"	136
M-1500	1500	63	25 - 160	2xS + 85	Yes	G1/8"	140
HD-1500	1500	63	25 - 300	2xS + 95	Yes	G1/8"	144
T-3000	3000	63	10 - 50	85 - 205	No	No	178
TS-3000	3000	63	10 - 65	85 - 256	No	No	182
TC-3000	3000	63	10 - 50	105 - 225	No	G1/8"	180
TSC-3000	3000	63	10 - 65	105 - 276	No	G1/8"	184
KH-1500	1500	75	25 - 125	2xS + 60	Yes	G1/8"	138
HG-1500	1500	75	25 - 200	2xS + 85	Yes	G1/8"	142
G-1500	1500	75	25 - 300	2xS + 110	Yes	G1/8"	146
KP-2400	2400	75	16 - 125	2xS + 45	Yes	M6	158
NR-2400	2400	75	16 - 125	2xS + 59	Yes	G1/8"	160
NT-2400	2400	75	16 - 125	2xS + 59	Yes	G1/8"	162
HD-2400	2400	75	25 - 300	2xS + 110	Yes	G1/8"	168
K-2500	2500	75	12 - 125	2xS + 60	Yes	G1/8"	164
M-2500	2500	75	25 - 160	2xS + 95	Yes	G1/8"	166
KC-3000	3000	75	12 - 125	2xS + 54	Yes	M6	172
T-4700	4700	75	10 - 50	80 - 240	No	No	208
TS-4700	4700	75	10 - 65	80 - 273	No	No	212
TC-4700	4700	75	10 - 50	100 - 260	No	G1/8"	210
TSC-4700	4700	75	10 - 65	100 - 293	No	G1/8"	214
HG-3000	3000	95	25 - 200	2xS + 95	Yes	G1/8"	174
G-3000	3000	95	25 - 300	2xS + 120	Yes	G1/8"	176
K-4000	4000	95	25 - 125	2xS + 70	Yes	G1/8"	194
M-4000	4000	95	25 - 160	2xS + 110	Yes	G1/8"	196
KP-4200	4200	95	16 - 125	2xS + 58	Yes	G1/8"	188
NR-4200	4200	95	16 - 125	2xS + 62	Yes	G1/8"	190
NT-4200	4200	95	16 - 125	2xS + 62	Yes	G1/8"	192
HD-4200	4200	95	25 - 300	2xS + 120	Yes	G1/8"	198
T-7500	7500	95	10 - 50	90 - 255	No	No	234
TS-7500	7500	95	10 - 65	90 - 279	No	No	238
TC-7500	7500	95	10 - 50	110 - 275	No	G1/8"	236
TSC-7500	7500	95	10 - 65	110 - 299	No	G1/8"	240
KC-5000	5000	105	12 - 125	2xS + 60	Yes	M6	202
HG-5000	5000	120	25 - 200	2xS + 102.5	Yes	G1/8"	204
G-5000	5000	120	25 - 300	2xS + 140	Yes	G1/8"	206
M-6500	6400	120	25 - 160	2xS + 115	Yes	G1/8"	224
KP-6600	6600	120	16 - 125	2xS + 68	Yes	G1/8"	218
NR-6600	6600	120	16 - 125	2xS + 72	Yes	G1/8"	220
NT-6600	6600	120	16 - 125	2xS + 72	Yes	G1/8"	222



Model	max F <sub>0</sub>	Ø mm	S mm	L mm		Linkable	Page
<b>HD-6600</b>	6600	120	25 - 300	2xS + 140	Yes	G1/8"	226
<b>T-11800</b>	11800	120	10 - 50	100 - 260	No	No	256
<b>TS-11800</b>	11800	120	10 - 65	100 - 320	No	No	260
<b>TC-11800</b>	11800	120	10 - 50	120 - 280	No	G1/8"	258
<b>TSC-11800</b>	11800	120	10 - 65	120 - 340	No	G1/8"	262
<b>HG-7500</b>	7500	150	25 - 200	2xS + 105	Yes	G1/8"	230
<b>CN-7500</b>	7500	150	25 - 300	2xS + 155	Yes	G1/8"	232
<b>KP-9500</b>	9500	150	19 - 125	2xS + 78	Yes	G1/8"	244
<b>NT-9500</b>	9500	150	25 - 125	2xS + 78	Yes	G1/8"	246
<b>HD-9500</b>	9500	150	25 - 300	2xS + 155	Yes	G1/8"	250
<b>G-10000</b>	9500	150	25 - 160	2xS + 136	Yes	G1/8"	248
<b>T-18300</b>	18300	150	10 - 50	110 - 270	No	No	270
<b>TS-18300</b>	18300	150	10 - 65	110 - 323	No	No	274
<b>TC-18300</b>	18300	150	10 - 50	130 - 290	No	G1/8"	272
<b>TSC-18300</b>	18300	150	10 - 65	130 - 343	No	G1/8"	276
<b>CN-10000</b>	10600	195	25 - 300	2xS + 160	Yes	G1/8"	252
<b>KP-20000</b>	20000	195	19 - 125	2xS + 110	No	G1/8"	266
<b>HD-20000</b>	20000	195	25 - 300	2xS + 160	No	G1/8"	268



## Force $\leq 100$ daN

**Piston Rod Sealed  
gas springs**

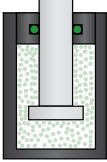

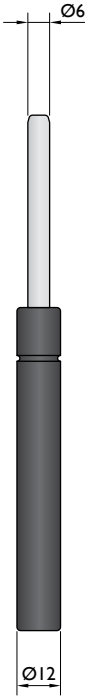

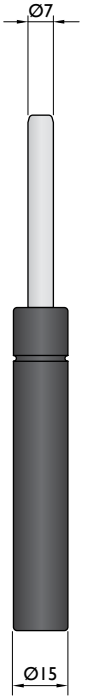

**Z-50**

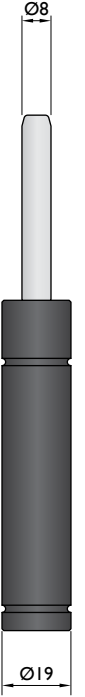

**Z-70**



**R-100**



**G-100**

<b>Model</b>	<b>Z-50</b>	<b>Z-70</b>	<b>R-100</b>	<b>G-100</b>
<b>Initial F (daN)</b>	13-50	18-70	30-90	30-90
<b>L max (mm)</b>	2xStroke+42	2xStroke+42	2xStroke+42	2xStroke+60
<b>Stroke (mm)</b>	7-125	7-125	7-125	12-125

\* other strokes under request

### Standards

<b>PED</b> 97/23/EC	<b>PED</b> 97/23/EC	<b>PED</b> 97/23/EC	<b>PED</b> 97/23/EC
ISO 11901	ISO 11901	ISO 11901	ISO 11901
VDI 3003	VDI 3003	VDI 3003	VDI 3003
CNOMO EM24.54.700	CNOMO EM24.54.700	CNOMO EM24.54.700	CNOMO EM24.54.700





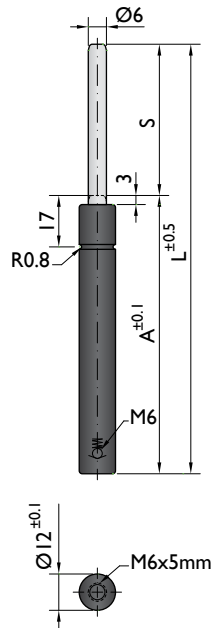

### Force / Pressure

		daN	bar (20°C)
V	GREEN	13	45
Z	BLUE	25	90
R	RED	38	135
A	YELLOW	50	180

\* maximum force if not specified

### Max. strokes / minutes

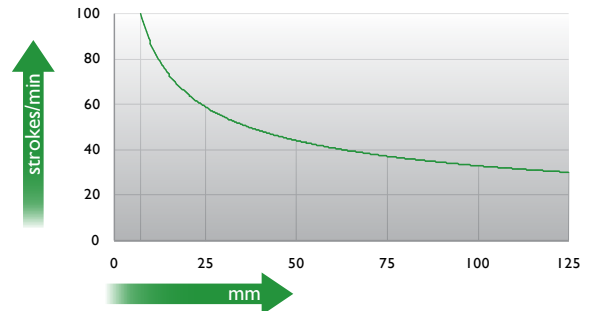

Ordering example: 4 x Z-50-125 V

Order No.	S <sup>(1)</sup> mm	L mm	A mm	F <sub>0</sub> <sup>(2)</sup> daN (20°C, 180 bar)	F daN		kg
Z-50-7	7	56	49		60	No	0.03
Z-50-10	10	62	52		60	No	0.03
Z-50-13	12.7	67.4	54.7		60	No	0.03
Z-50-15	15	72	57		70	No	0.03
Z-50-19	19	80	61		70	No	0.04
Z-50-25	25	92	67		70	No	0.04
Z-50-38	38	118	80	50	70	No	0.04
Z-50-50	50	142	92		70	No	0.05
Z-50-63	63.5	172	108.5		80	No	0.06
Z-50-75	75	195	120		80	No	0.06
Z-50-80	80	205	125		80	No	0.07
Z-50-100	100	245	145		80	No	0.07
Z-50-125	125	295	170		80	No	0.09

<sup>(1)</sup> other strokes under request

<sup>(2)</sup> alternative forces upon request



Pressure medium	N <sub>2</sub>	Working temperature	0-80°C	Min. security stroke	10%
Max. Charging pressure	180 bar	Temperature related force increase	+0.34%/°C	Repair Kit	Non-repairable
Min. Charging pressure	25 bar	Max. working speed	1.6 m/s	Linkable	No

### Mounting possibilities

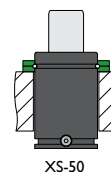
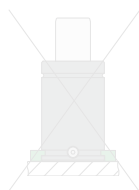
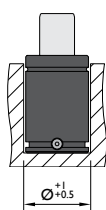
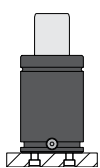

## Flanges

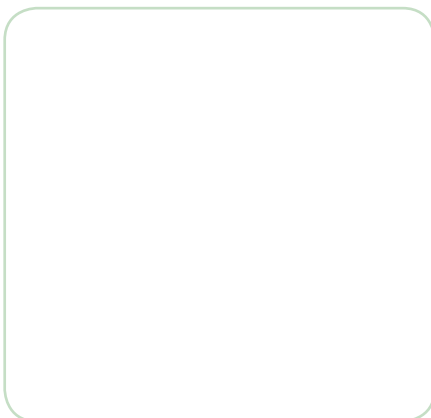
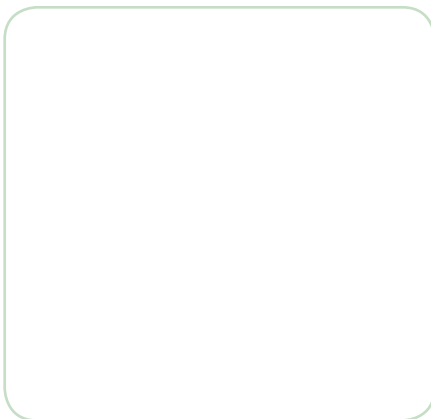
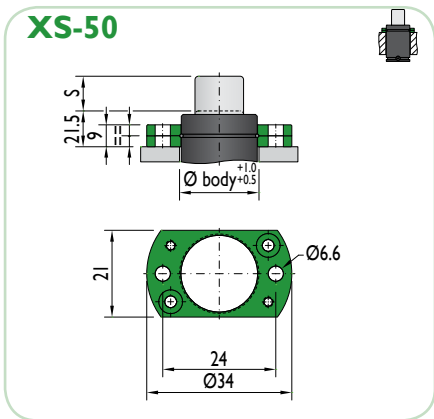

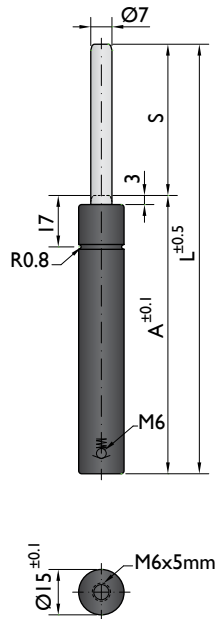

### Force / Pressure

		daN	bar (20°C)
V	GREEN	18	45
Z	BLUE	35	90
R	RED	50	135
A	YELLOW	70	180

\* maximum force if not specified

### Max. strokes / minutes

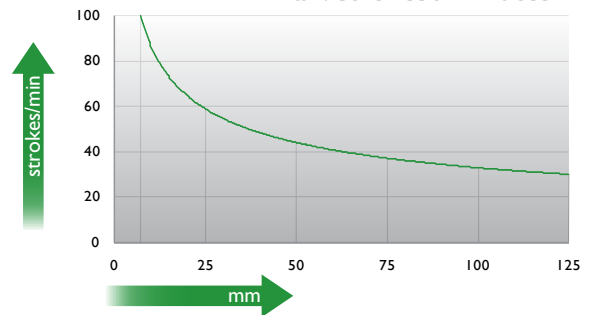

Ordering example: 4 x Z-70-125 R

Order No.	S <sup>(1)</sup> mm	L mm	A mm	F <sub>0</sub> <sup>(2)</sup> daN (20°C, 180 bar)	F daN		kg
Z-70-7	7	56	49		90	No	0.05
Z-70-10	10	62	52		90	No	0.05
Z-70-13	12.7	67.4	54.7		90	No	0.05
Z-70-15	15	72	57		90	No	0.05
Z-70-19	19	80	61		90	No	0.05
Z-70-25	25	92	67		100	No	0.06
Z-70-38	38.1	118.2	80.1	70	100	No	0.07
Z-70-50	50	142	92		100	No	0.08
Z-70-63	63.5	172	108.5		110	No	0.09
Z-70-75	75	195	120		110	No	0.10
Z-70-80	80	205	125		110	No	0.11
Z-70-100	100	245	145		110	No	0.12
Z-70-125	125	295	170		110	No	0.14

<sup>(1)</sup> other strokes under request

<sup>(2)</sup> alternative forces upon request



Pressure medium	N <sub>2</sub>	Working temperature	0-80°C	Min. security stroke	10%
Max. Charging pressure	180 bar	Temperature related force increase	+0.34%/°C	Repair Kit	Non-repairable
Min. Charging pressure	25 bar	Max. working speed	1.6 m/s	Linkable	No

### Mounting possibilities

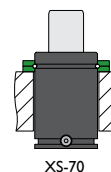
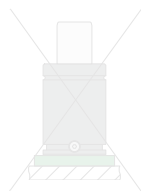
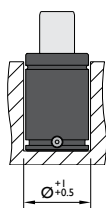
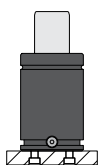

## Flanges

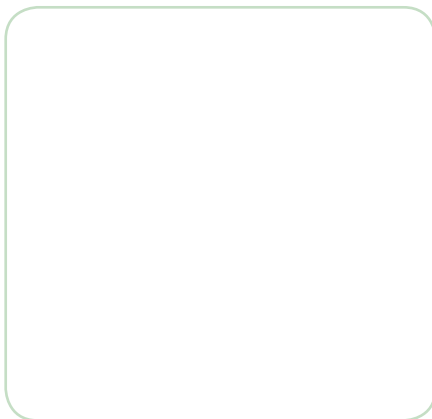
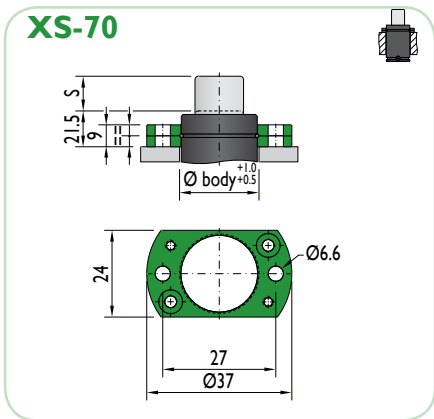
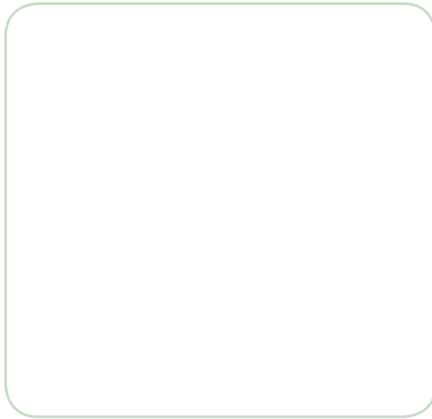



\*The new cylinder will be supplied when the stock runs out.

### NEW MODEL\*

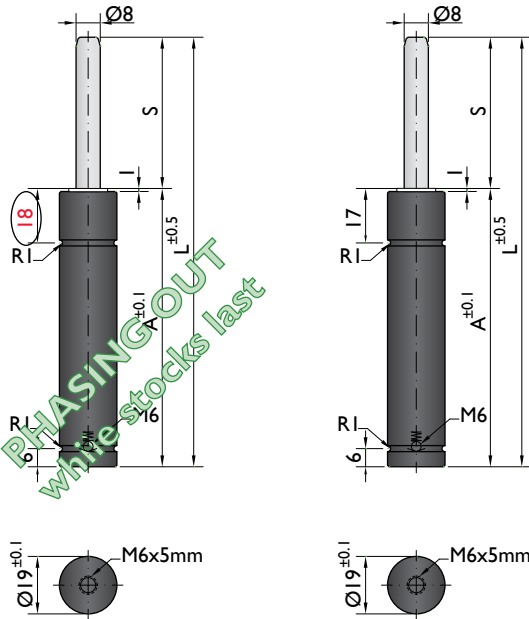

### Force / Pressure

		daN	bar (20°C)
V	GREEN	30	60
Z	BLUE	50	100
R	RED	70	140
A	YELLOW	90	180

\* maximum force if not specified

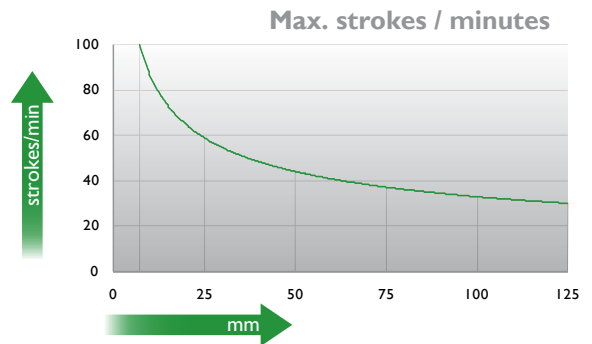

Ordering example: 4 x R-100-100 V

Order No.	S <sup>(1)</sup> mm	L mm	A mm	F <sub>0</sub> <sup>(2)</sup> daN	F daN	kg
				(20°C, 180 bar)		
R-100-7	7	56	49		110	0.07
R-100-10	10	62	52		110	0.08
R-100-15	15	72	57		115	0.08
R-100-25	25	92	67		120	0.08
R-100-38	38.1	118.2	80.1	90	120	0.10
R-100-50	50	142	92		120	0.12
R-100-63	63.5	172	108.5		120	0.13
R-100-80	80	205	125		120	0.14
R-100-100	100	245	145		120	0.17
R-100-125	125	295	170		125	0.20

<sup>(1)</sup> other strokes under request

<sup>(2)</sup> alternative forces upon request



Pressure medium	N <sub>2</sub>	Working temperature	0-80°C	Min. security stroke	10%
Max. Charging pressure	180 bar	Temperature related force increase	+0.34%/°C	Repair Kit	Non-repairable
Min. Charging pressure	25 bar	Max. working speed	1.6 m/s	Linkable	No

### Mounting possibilities

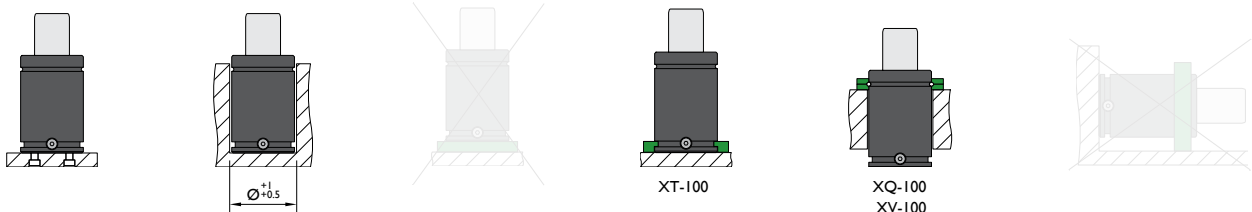

## Flanges



**XT-100**

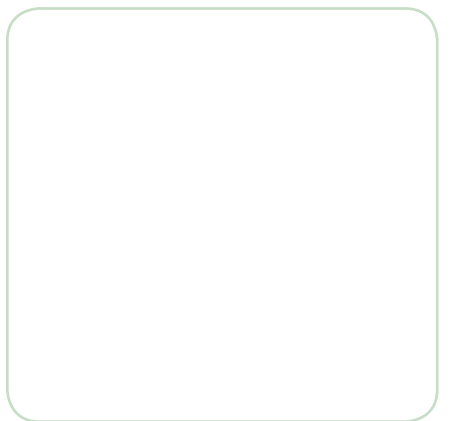
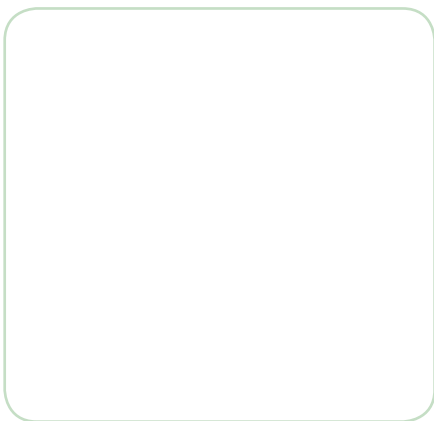

**XQ-100**

**XV-100**

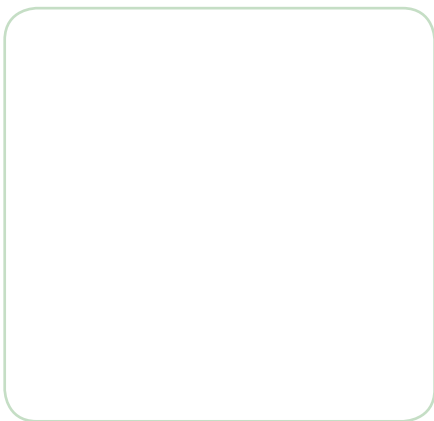
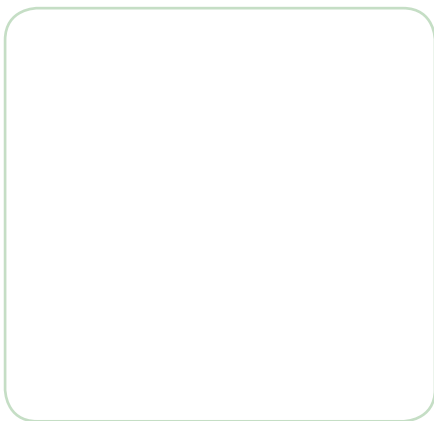





\*The new cylinder will be supplied when the stock runs out.

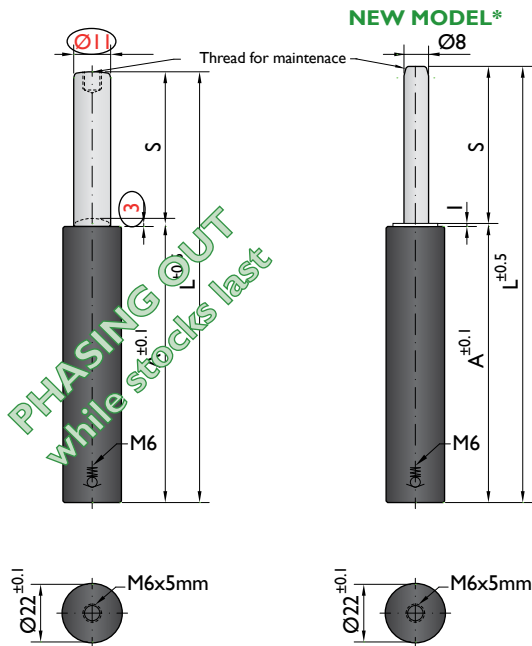

### Force / Pressure

		daN	bar (20°C)
V	GREEN	30	60
Z	BLUE	50	100
R	RED	70	140
A	YELLOW	90	180

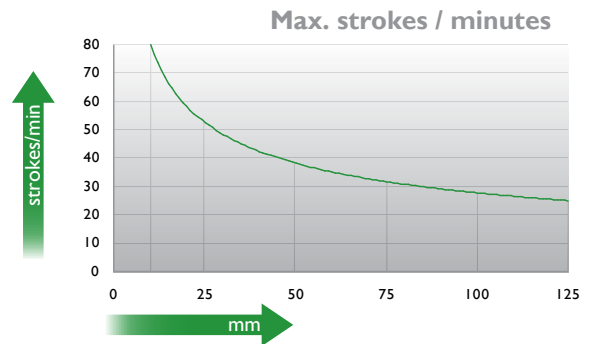

Ordering example: 4 x G-100-125

Order No.	S <sup>(1)</sup> mm	L mm	A mm	F <sub>0</sub> <sup>(2)</sup> daN (20°C, 180 bar)	F daN		kg
G-100-12	12	84	72	90	120	No	0.14
G-100-25	25	110	85		140	No	0.16
G-100-38	38	136	98		150	No	0.18
G-100-50	50	160	110		160	No	0.20
G-100-63	63	186	123		170	No	0.25
G-100-80	80	220	140		170	No	0.30
G-100-100	100	260	160		180	No	0.35
G-100-125	125	310	185		220	No	0.40

<sup>(1)</sup> other strokes under request

<sup>(2)</sup> alternative forces upon request



Pressure medium	N <sub>2</sub>	Working temperature	0-80°C	Min. security stroke	10%
Max. Charging pressure	180 bar	Temperature related force increase	+0.34%/°C	Repair Kit	KIT G-100
Min. Charging pressure	25 bar	Max. working speed	1.6 m/s	Linkable	No

### Mounting possibilities

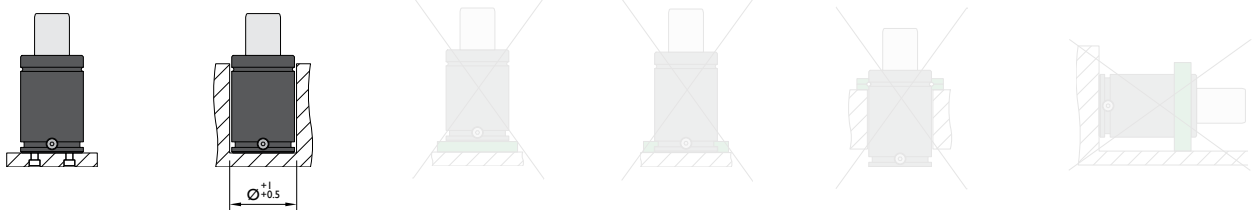

## Flanges



## Force 150 - 200 daN

### Piston Rod Sealed gas springs

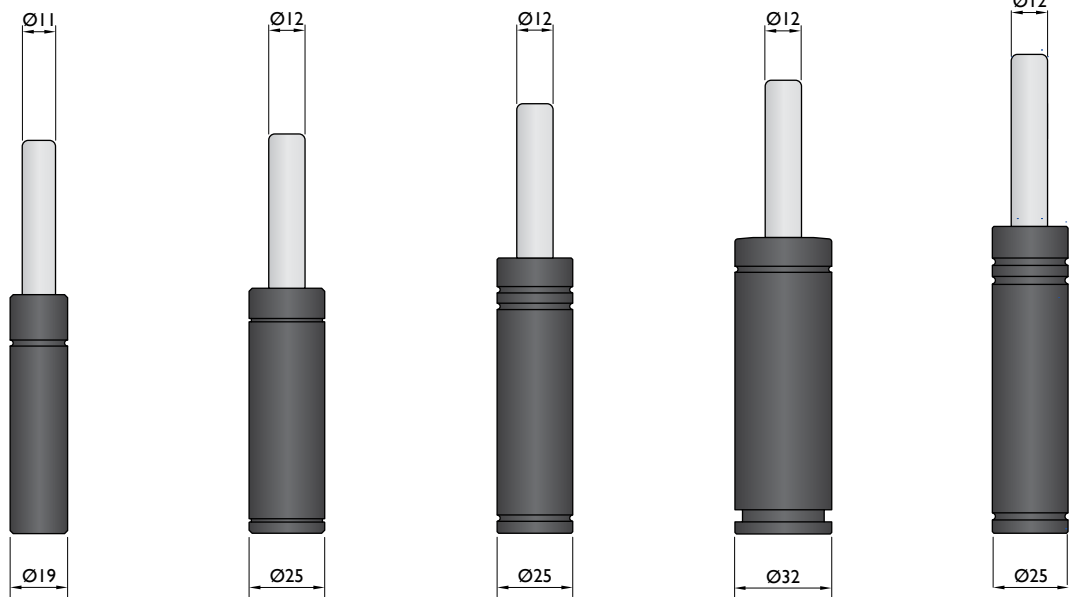
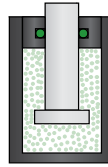

Model	KP-150	K-200	R-200	CN-150	G-200
Initial F (daN)	150	50-200	50-200	150	50-200
L max (mm)	2xStroke+30	2xStroke+32	2xStroke+42	2xStroke+50	2xStroke+54
Stroke (mm)	7-125	7-125	10-125	10-125	12-125

\* other strokes under request

### Standards

PED 97/23/EC	PED 97/23/EC	PED 97/23/EC	PED 97/23/EC	PED 97/23/EC
ISO 11901	ISO 11901	ISO 11901	ISO 11901	ISO 11901
VDI 3003	VDI 3003	VDI 3003	VDI 3003	VDI 3003
CNOMO EM24.54.700	CNOMO EM24.54.700	CNOMO EM24.54.700	CNOMO EM24.54.700	CNOMO EM24.54.700



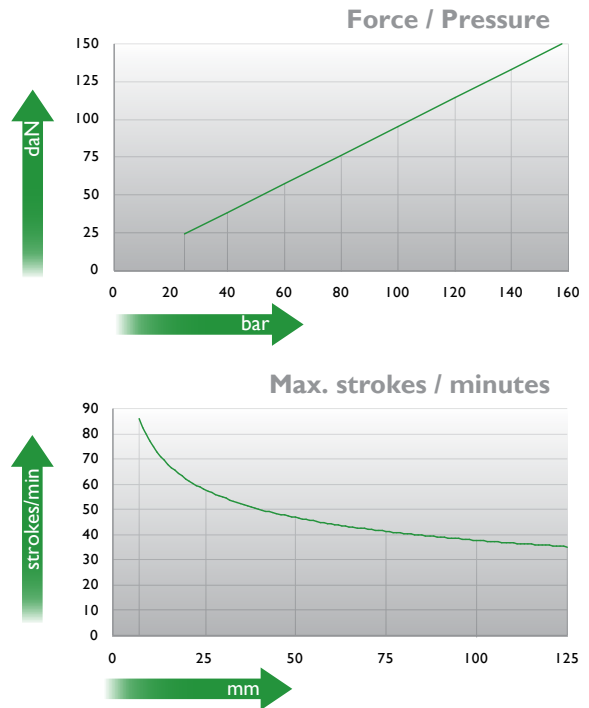
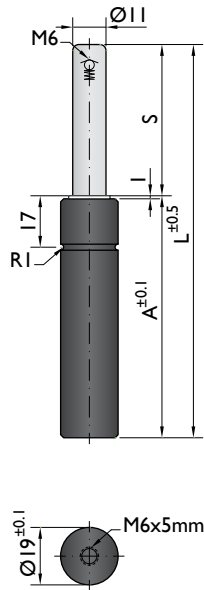

Ordering example: 4 x KP-150-125

Order No.	S <sup>(1)</sup> mm	L mm	A mm	F <sub>0</sub> <sup>(2)</sup> daN	F daN	kg
(20°C, 160 bar)						
KP-150-7	7	44	37	150	240	0.05
KP-150-10	10	50	40		250	0.07
KP-150-15	15	60	45		280	0.07
KP-150-19	19	68	49		280	0.07
KP-150-25	25	80	55		280	0.09
KP-150-38	38	106	68		280	0.10
KP-150-50	50	130	80		280	0.12
KP-150-63	63	156	93		280	0.14
KP-150-75	75	185	110		280	0.15
KP-150-80	80	195	115		280	0.17
KP-150-100	100	235	135		280	0.20
KP-150-125	125	285	160		280	0.23

<sup>(1)</sup> other strokes under request

<sup>(2)</sup> alternative forces upon request



Pressure medium	N <sub>2</sub>	Working temperature	0-80°C	Min. security stroke	10%
Max. Charging pressure	160 bar	Temperature related force increase	+0.34%/°C	Repair Kit	Non-repairable
Min. Charging pressure	25 bar	Max. working speed	1.6 m/s	Linkable	No

### Mounting possibilities

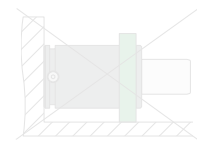
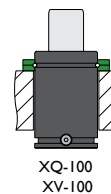
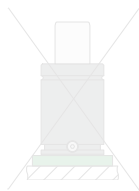
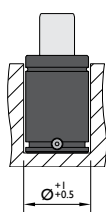
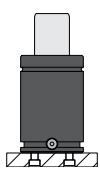

## Flanges



**XQ-100**

ISO

**XV-100**

VDI



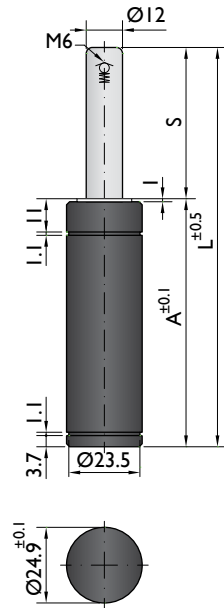

### Force / Pressure

		daN	bar (20°C)
V	GREEN	50	45
Z	BLUE	100	90
R	RED	150	135
A	YELLOW	200	180

\* maximum force if not specified

### Max. strokes / minutes

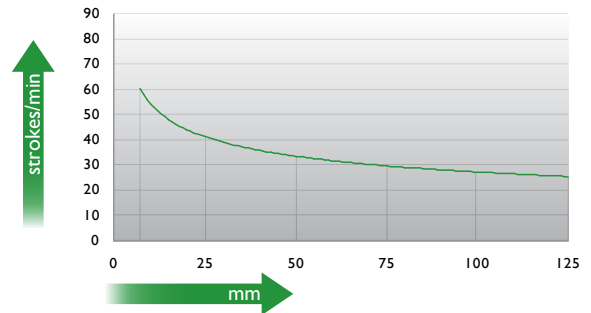

Ordering example: 4 x K-200-125 V

Order No.	S <sup>(1)</sup> mm	L mm	A mm	F <sub>0</sub> <sup>(2)</sup> daN (20°C, 180 bar)	F daN		kg
K-200-7	7	46	39	200	300	No	0.11
K-200-12	12	56	44		300	No	0.12
K-200-16	16	64	48		300	No	0.13
K-200-25	25	82	57		310	No	0.15
K-200-38	38	108	70		310	No	0.18
K-200-50	50	132	82		310	No	0.21
K-200-63	63	158	95		310	No	0.24
K-200-80	80	192	112		310	No	0.28
K-200-100	100	232	132		310	No	0.30
K-200-125	125	282	157		310	No	0.33

<sup>(1)</sup> other strokes under request

<sup>(2)</sup> alternative forces upon request



Pressure medium	N <sub>2</sub>	Working temperature	0-80°C	Min. security stroke	10%
Max. Charging pressure	180 bar	Temperature related force increase	+0.34%/°C	Repair Kit	KIT K-200
Min. Charging pressure	25 bar	Max. working speed	1.6 m/s	Linkable	No

### Mounting possibilities

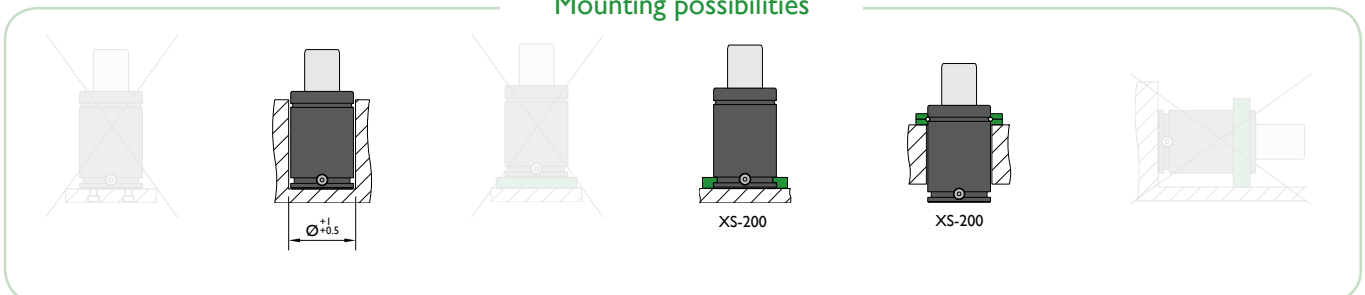

## Flanges

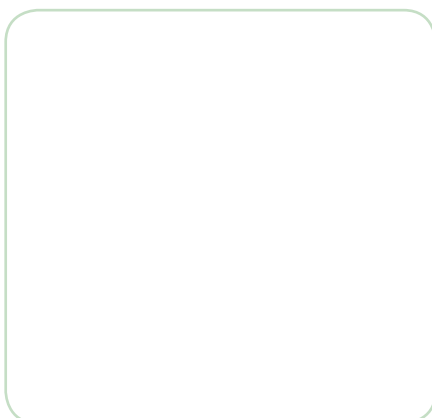
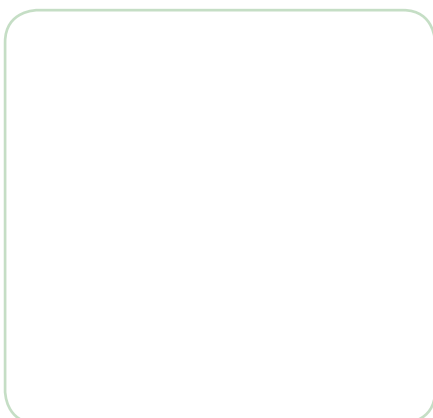
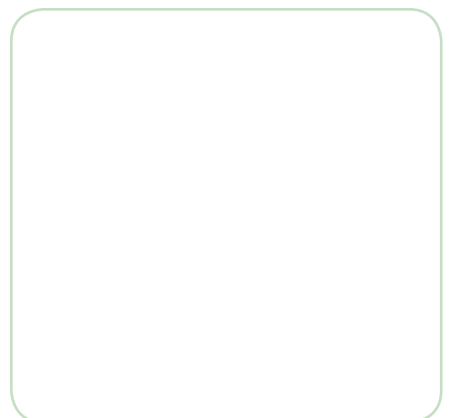
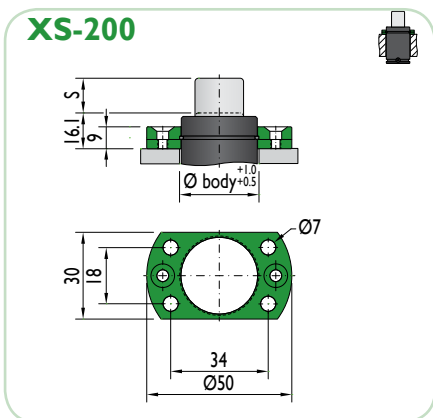
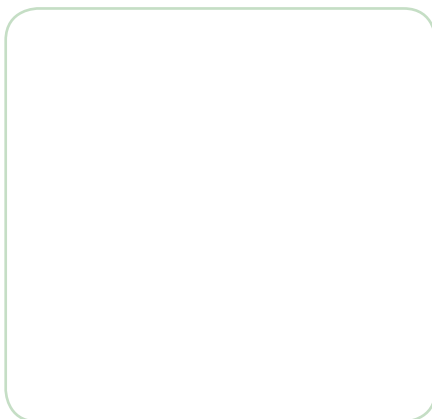
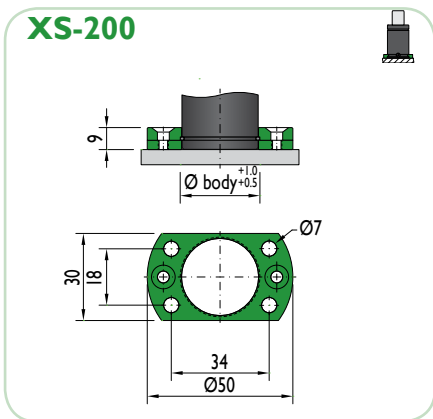

Special mounts available on  
[www.nitrogas.com](http://www.nitrogas.com)





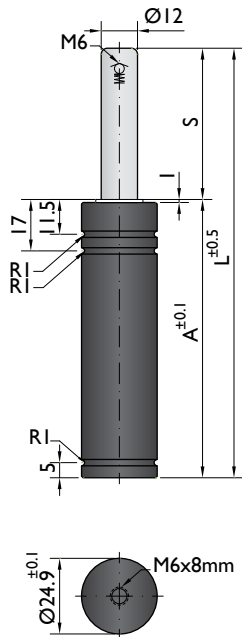

### Force / Pressure

		daN	bar (20°C)
V	GREEN	50	45
Z	BLUE	100	90
R	RED	150	135
A	YELLOW	200	180

\* maximum force if not specified

### Max. strokes / minutes

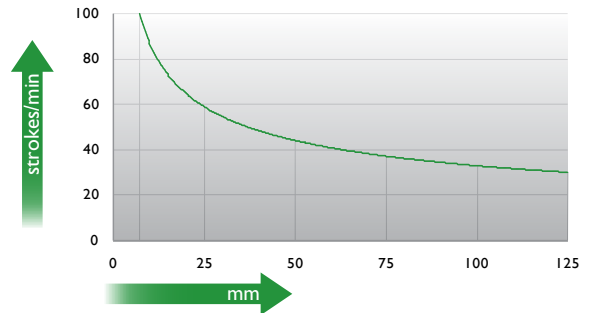

Ordering example: 4 x R-200-125 V

Order No.	S <sup>(1)</sup> mm	L mm	A mm	F <sub>0</sub> <sup>(2)</sup> daN (20°C, 180 bar)	F daN		kg
R-200-10	10	62	52		260	No	0.14
R-200-13	12.7	67.4	54.7		260	No	0.15
R-200-15	15	72	57		260	No	0.15
R-200-16	16	74	58		260	No	0.16
R-200-25	25	92	67		270	No	0.17
R-200-38	38.1	118.2	80.1	200	280	No	0.20
R-200-50	50	142	92		280	No	0.22
R-200-63	63.5	172	108.5		290	No	0.25
R-200-80	80	205	125		290	No	0.28
R-200-100	100	245	145		290	No	0.32
R-200-125	125	295	170		290	No	0.37

<sup>(1)</sup> other strokes under request

<sup>(2)</sup> alternative forces upon request



Pressure medium	N <sub>2</sub>	Working temperature	0-80°C	Min. security stroke	10%
Max. Charging pressure	180 bar	Temperature related force increase	+0.34%/°C	Repair Kit	KIT R-200
Min. Charging pressure	25 bar	Max. working speed	1.6 m/s	Linkable	No

### Mounting possibilities

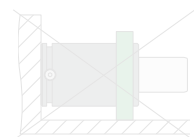
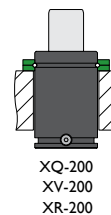
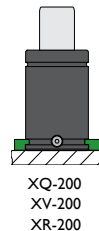
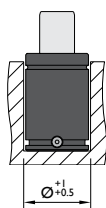
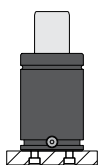

## Flanges

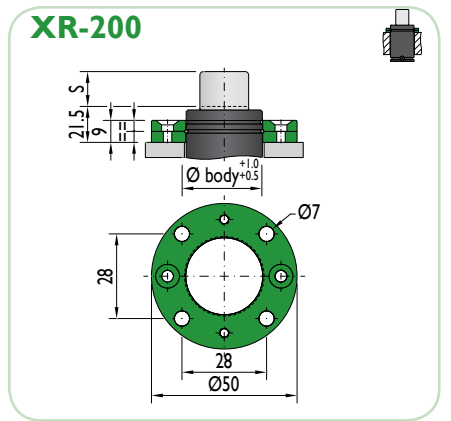
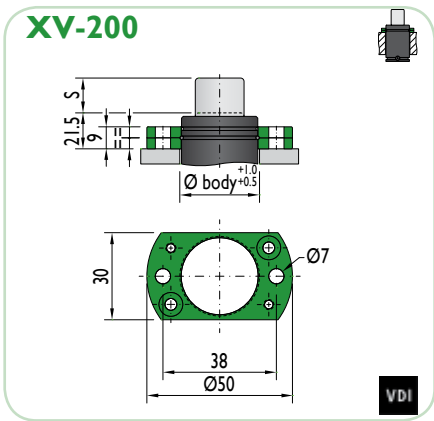
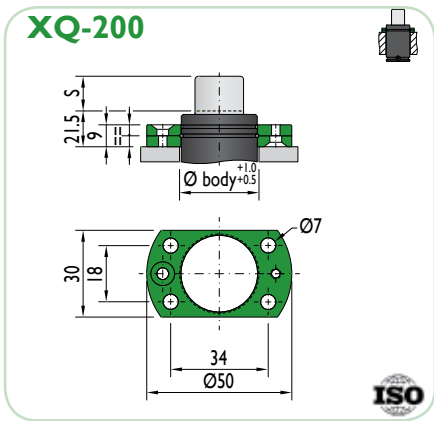
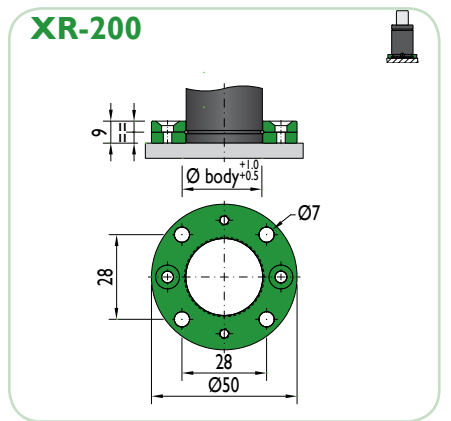
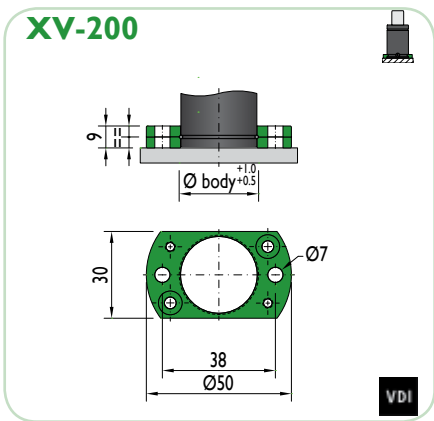
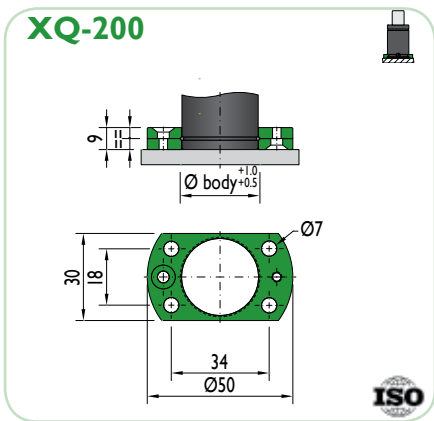



CNOMO  
EM24.54.700

PSA  
E24.54.815.G

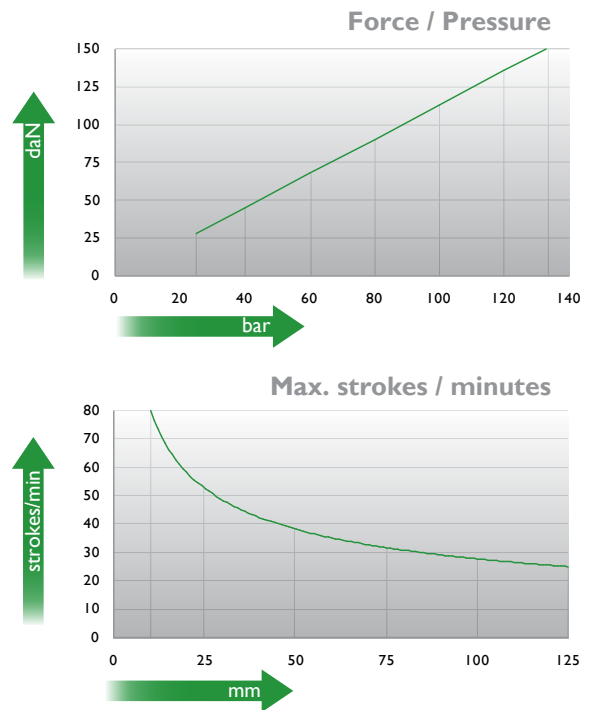
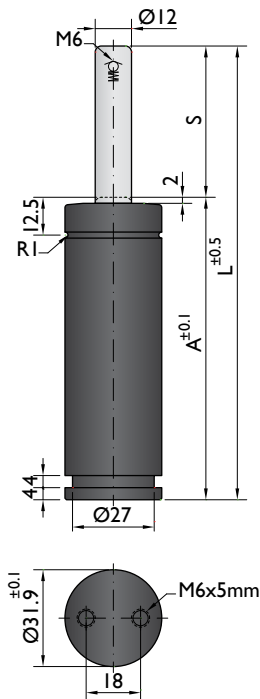

Ordering example: 4 x CN-150-125

Order No.	S <sup>(1)</sup> mm	L mm	A mm	F <sub>0</sub> <sup>(2)</sup> daN	F daN	kg
CN-150-10	10	70	60	150	170	0.27
CN-150-13	12.7	75.4	62.7		180	0.28
CN-150-16	16	82	66		180	0.29
CN-150-25	25	100	75		180	0.33
CN-150-38	38.1	126.2	88.1		180	0.38
CN-150-50	50	150	100		190	0.43
CN-150-63	63.5	177	113.5		200	0.48
CN-150-80	80	210	130		200	0.56
CN-150-100	100	250	150		200	0.64
CN-150-125	125	300	175		200	0.73

<sup>(1)</sup> other strokes under request

<sup>(2)</sup> alternative forces upon request



Pressure medium	N <sub>2</sub>	Working temperature	0-80°C	Min. security stroke	10%
Max. Charging pressure	135 bar	Temperature related force increase	+0.34%/°C	Repair Kit	KIT CN-150
Min. Charging pressure	25 bar	Max. working speed	1.6 m/s	Linkable	No

## Mounting possibilities

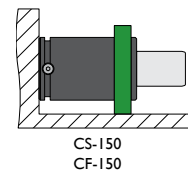
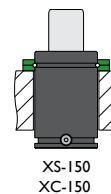
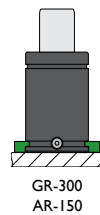
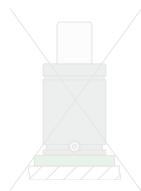
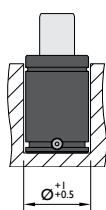
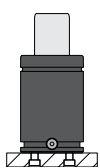

Flange must not support spring's force

## Flanges

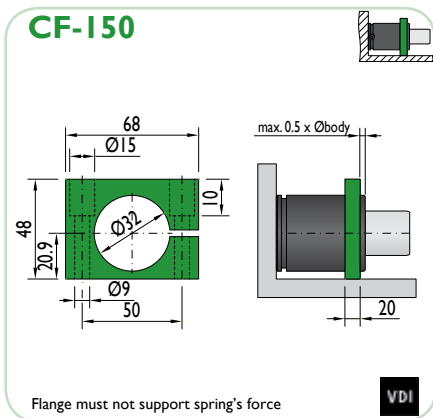
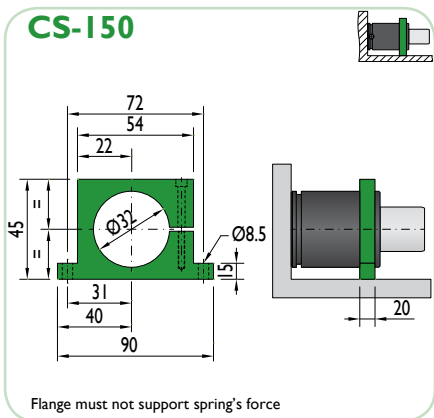
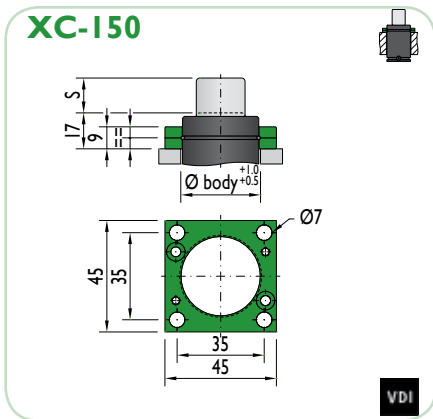
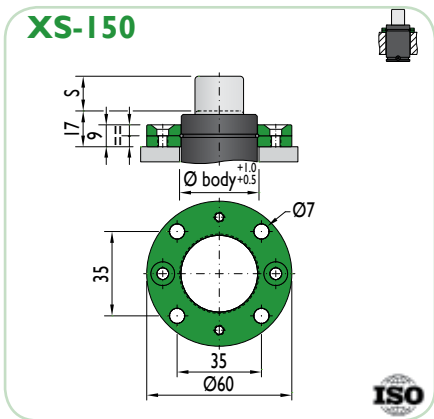
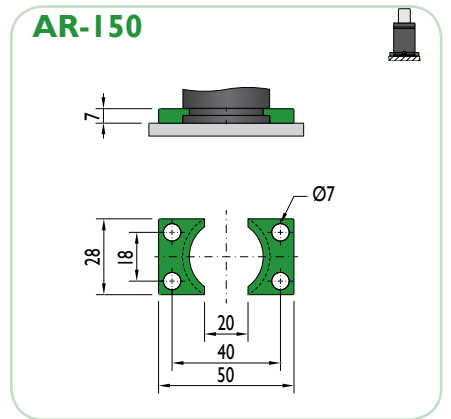
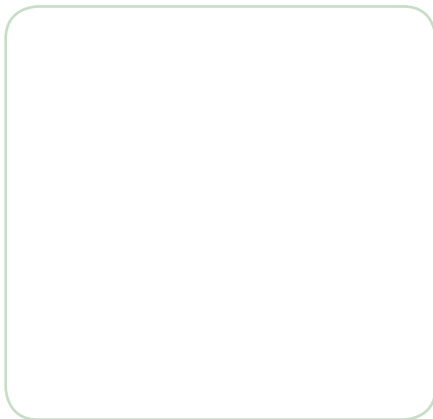
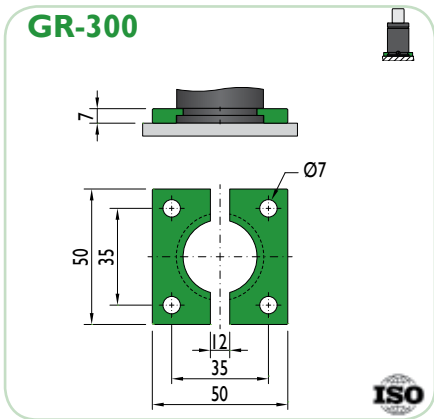



\*The new cylinder will be supplied when the stock runs out.

### NEW MODEL\*

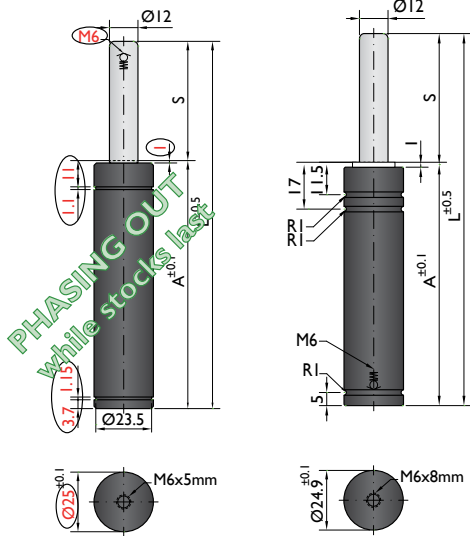

### Force / Pressure

		daN	bar (20°C)
V	GREEN	50	45
Z	BLUE	100	90
R	RED	150	135
A	YELLOW	200	180

\* maximum force if not specified

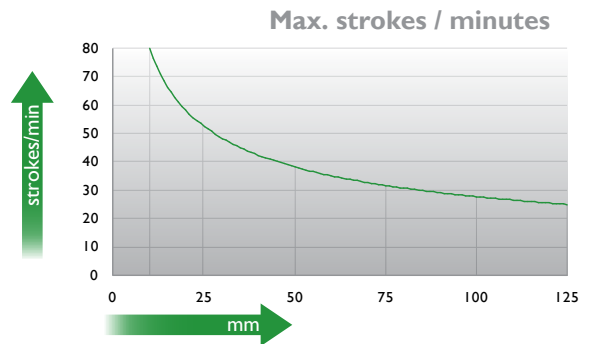

Ordering example: 4 x G-200-80 Z

Order No.	S <sup>(1)</sup> mm	L mm	A mm	F <sub>0</sub> <sup>(2)</sup> daN (20°C, 180 bar)	F daN		kg
G-200-12	12	78	66	200	230	No	0.16
G-200-25	25	104	79		250	No	0.19
G-200-38	38	130	92		260	No	0.22
G-200-50	50	154	104		270	No	0.25
G-200-63	63	180	117		290	No	0.29
G-200-80	80	214	134		290	No	0.33
G-200-100 (*)	100	254	154		310	No	0.36
G-200-125 (*)	125	304	179		310	No	0.42

other strokes <sup>(1)</sup> under request

alternative forces <sup>(2)</sup> upon request

\* New version length



Pressure medium	N <sub>2</sub>	Working temperature	0-80°C	Min. security stroke	10%
Max. Charging pressure	180 bar	Temperature related force increase	+0.34%/°C	Repair Kit	KIT G-200
Min. Charging pressure	25 bar	Max. working speed	1.6 m/s	Linkable	No

### Mounting possibilities

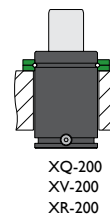
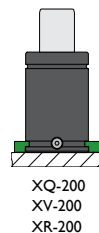
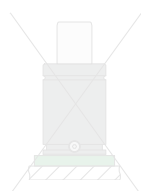
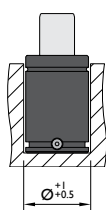
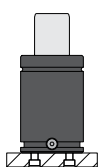

## Flanges

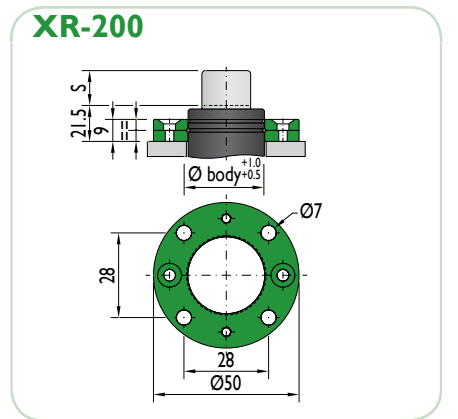
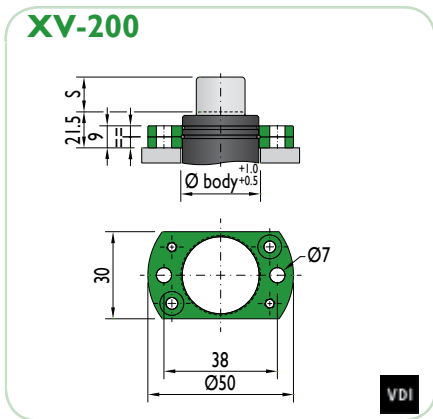
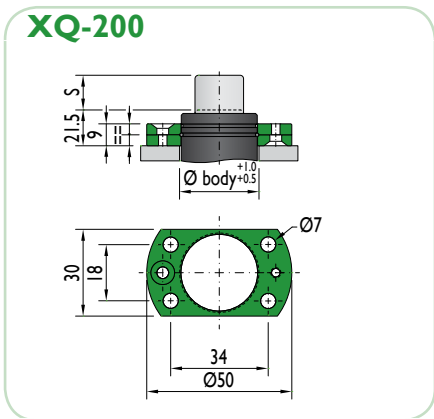
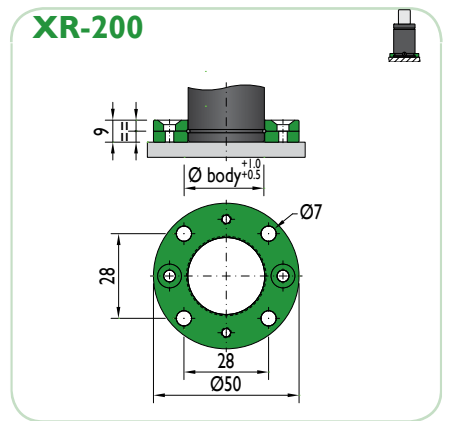
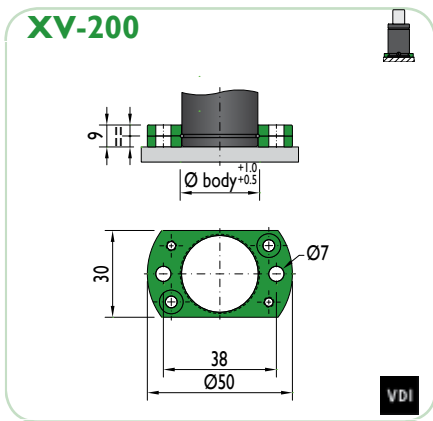
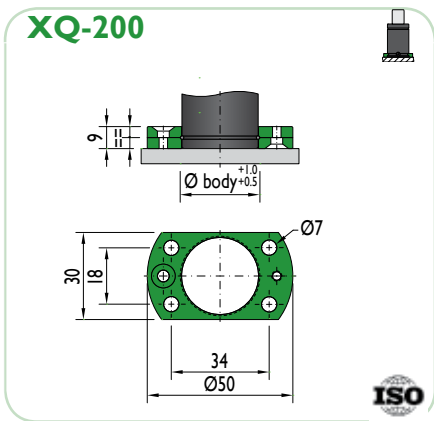

## Force 250 - 300 daN

### Piston Rod Sealed gas springs

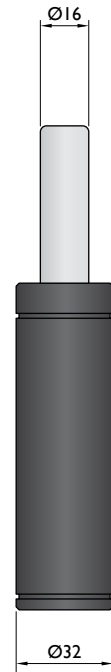
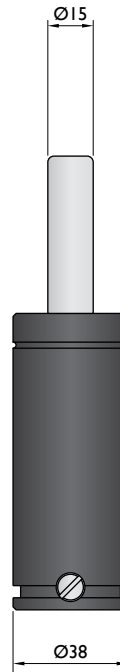
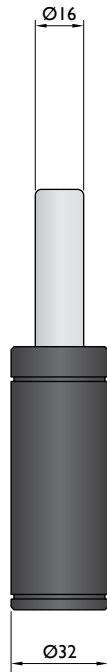
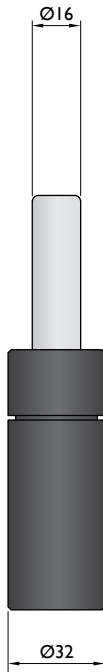
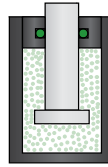

<b>Model</b>	<b>KC-300</b>	<b>K-300</b>	<b>CN-250</b>	<b>G-300</b>
<b>Initial F (daN)</b>	300	100-300	265	100-300
<b>L max (mm)</b>	2xStroke+37	2xStroke+39	2xStroke+50	2xStroke+60
<b>Stroke (mm)</b>	7-125	7-125	10-125	12-125

\* other strokes under request

### Standards

<b>PED</b> 97/23/EC	<b>PED</b> 97/23/EC	<b>PED</b> 97/23/EC	<b>PED</b> 97/23/EC
<b>ISO</b> 11901	<b>ISO</b> 11901	<b>ISO</b> 11901	<b>ISO</b> 11901
<b>VDI</b> 3003	<b>VDI</b> 3003	<b>VDI</b> 3003	<b>VDI</b> 3003
<b>CNOMO</b> EM24.54.700	<b>CNOMO</b> EM24.54.700	<b>CNOMO</b> EM24.54.700	<b>CNOMO</b> EM24.54.700





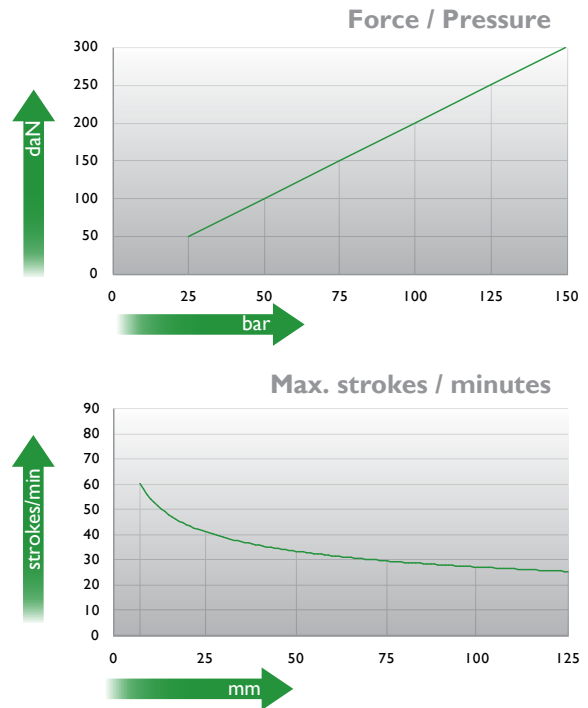
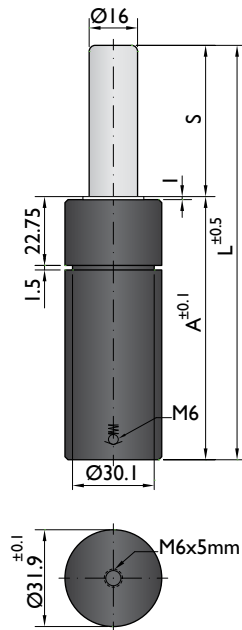

Ordering example: 4 x KC-300-125

Order No.	S <sup>(1)</sup> mm	L mm	A mm	F <sub>0</sub> <sup>(2)</sup> daN	F daN	kg
(20°C, 150 bar)						
KC-300-7	7	51	44	300	420	0.19
KC-300-12	12	61	49		440	0.21
KC-300-16	16	69	53		440	0.23
KC-300-25	25	87	62		440	0.25
KC-300-38	38	113	75		450	0.30
KC-300-50	50	137	87		450	0.33
KC-300-63	63	163	100		450	0.38
KC-300-80	80	197	117		450	0.44
KC-300-100	100	237	137		450	0.51
KC-300-125	125	287	162		460	0.58

<sup>(1)</sup> other strokes under request

<sup>(2)</sup> alternative forces upon request



Pressure medium	N <sub>2</sub>	Working temperature	0-80°C	Min. security stroke	10%
Max. Charging pressure	150 bar	Temperature related force increase	+0.34%/°C	Repair Kit	KIT KC-300
Min. Charging pressure	25 bar	Max. working speed	1.6 m/s	Linkable	No

### Mounting possibilities

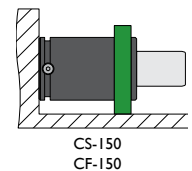
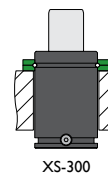
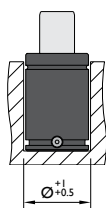
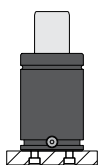

Flange must not support spring's force

## Flanges

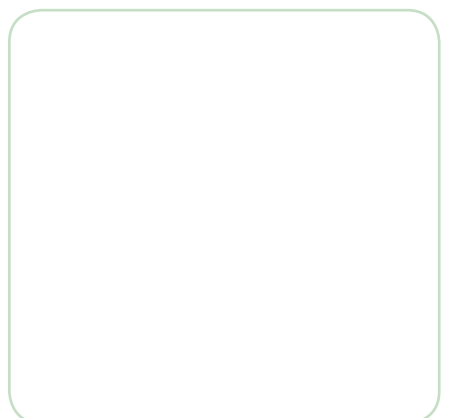
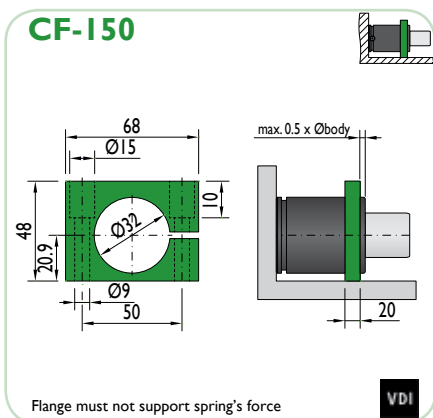
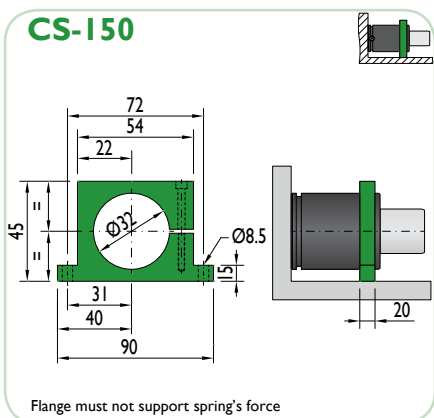
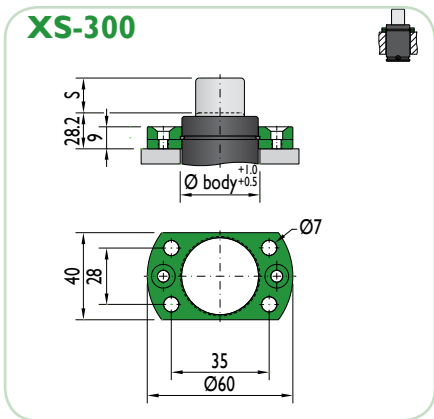

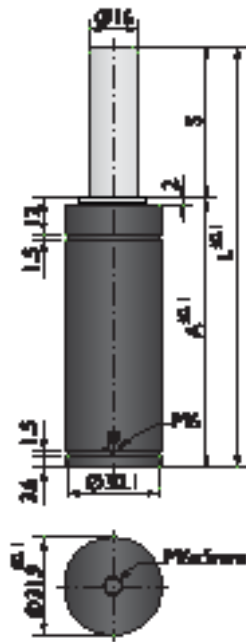

### Force / Pressure

		daN	bar (20°C)
V	GREEN	100	50
Z	BLUE	200	100
R	RED	250	125
A	YELLOW	300	150

\* maximum force if not specified

### Max. strokes / minutes

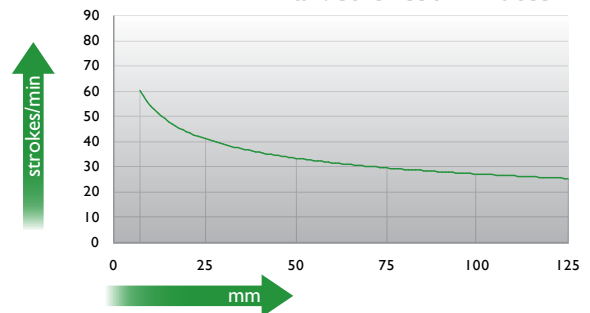

Ordering example: 4 x K-300-125 V

Order No.	S <sup>(1)</sup> mm	L mm	A mm	F <sub>0</sub> <sup>(2)</sup> daN (20°C, 150 bar)	F daN		kg
K-300-7	7	53	46	300	400	No	0.23
K-300-12	12	63	51		420	No	0.24
K-300-16	16	71	55		420	No	0.25
K-300-25	25	89	64		430	No	0.28
K-300-38	38	115	77		450	No	0.32
K-300-50	50	139	89		450	No	0.36
K-300-63	63	165	102		450	No	0.40
K-300-80	80	199	119		450	No	0.46
K-300-100	100	239	139		450	No	0.53
K-300-125	125	289	164		460	No	0.59

<sup>(1)</sup> other strokes under request

<sup>(2)</sup> alternative forces upon request



Pressure medium	N <sub>2</sub>	Working temperature	0-80°C	Min. security stroke	10%
Max. Charging pressure	150 bar	Temperature related force increase	+0.34%/°C	Repair Kit	KIT K-300
Min. Charging pressure	25 bar	Max. working speed	1.6 m/s	Linkable	No

### Mounting possibilities

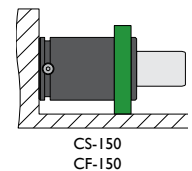
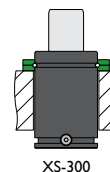
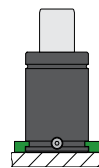
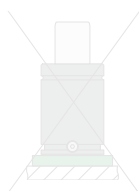
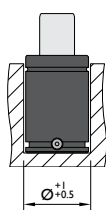
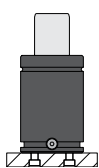

Flange must not support spring's force

## Flanges

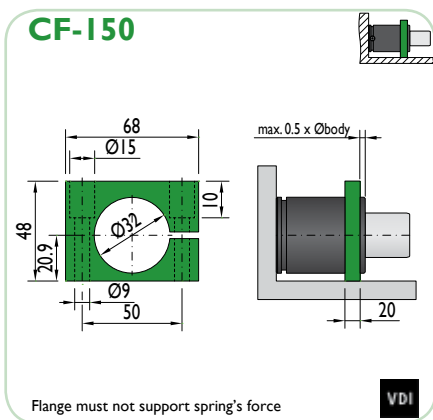
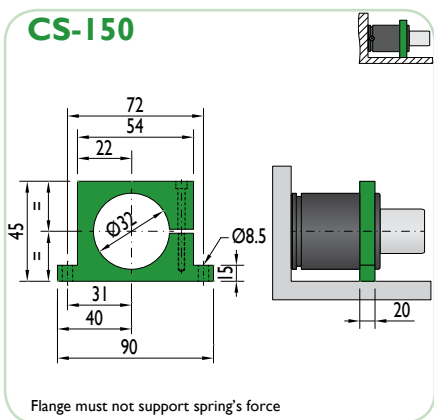
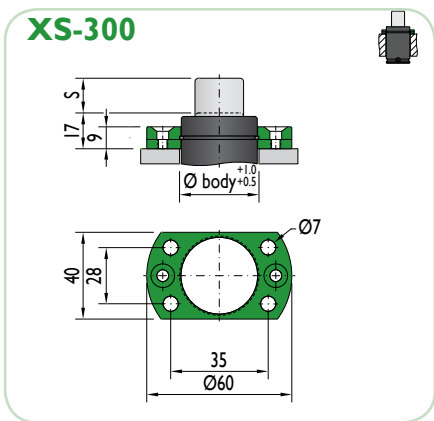
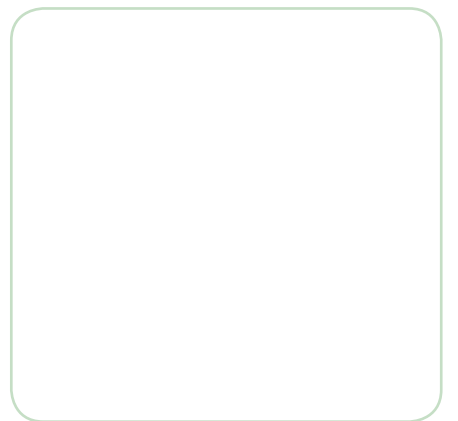
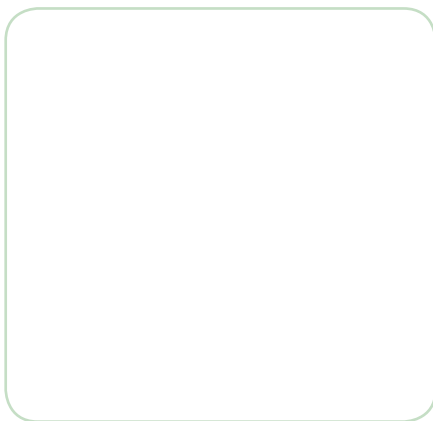
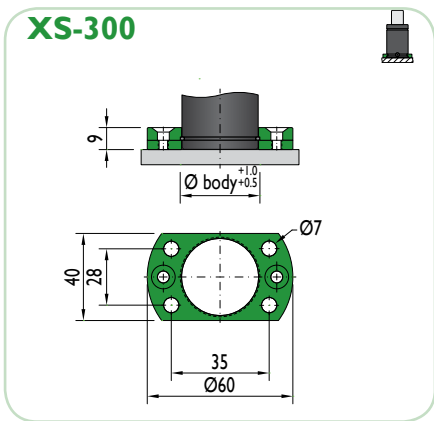



CNOMO  
EM24.54.700

PSA  
E24.54.815.G

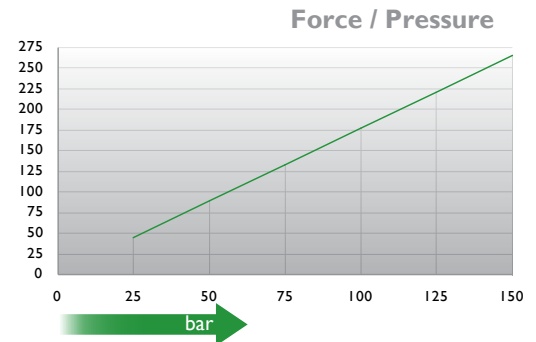
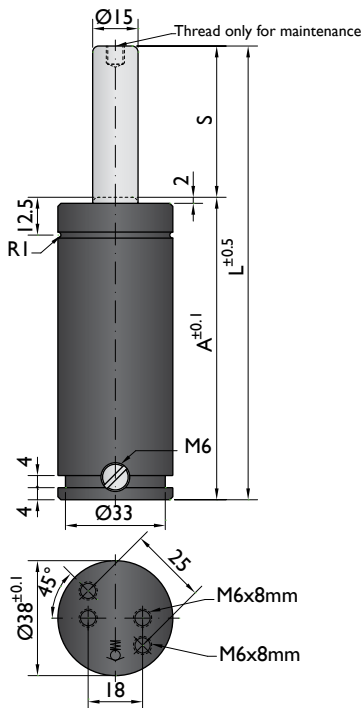

↑ daN

→ bar

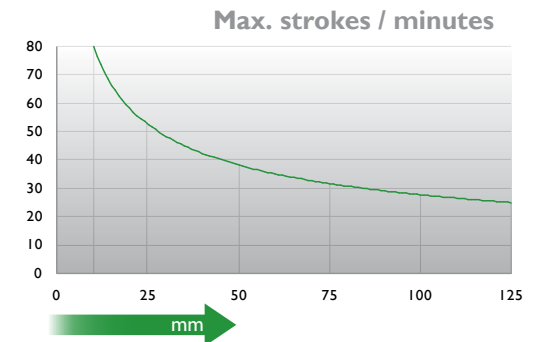

↑ strokes/min

→ mm

Ordering example: 4 x CN-250-125

Order No.	S <sup>(1)</sup> mm	L mm	A mm	F <sub>0</sub> <sup>(2)</sup> daN	F daN	Linkable	kg
CN-250-10	10	70	60		310	No	0.40
CN-250-13	12.7	75.4	62.7		310	No	0.42
CN-250-16	16	82	66		320	No	0.43
CN-250-19	19	88	69		330	No	0.45
CN-250-25	25	100	75		330	No	0.51
CN-250-38	38.1	126.2	88.1	265	340	No	0.57
CN-250-50	50	150	100		350	No	0.63
CN-250-63	63.5	177	113.5		350	No	0.75
CN-250-80	80	210	130		360	No	0.81
CN-250-100	100	250	150		360	No	0.92
CN-250-125	125	300	175		360	No	1.10

<sup>(1)</sup> other strokes under request

<sup>(2)</sup> alternative forces upon request



Pressure medium	N <sub>2</sub>	Working temperature	0-80°C	Min. security stroke	10%
Max. Charging pressure	150 bar	Temperature related force increase	+0.34%/°C	Repair Kit	KIT CN-250
Min. Charging pressure	25 bar	Max. working speed	1.6 m/s	Linkable	M6

## Mounting possibilities

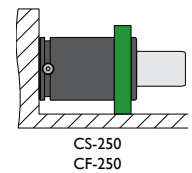
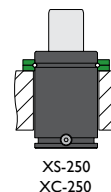
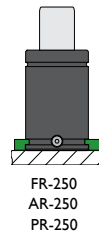
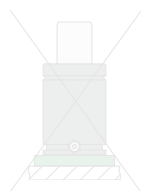
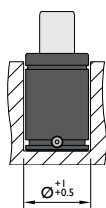
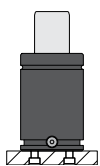

Flange must not support spring's force

## Flanges



**FR-250**

ISO

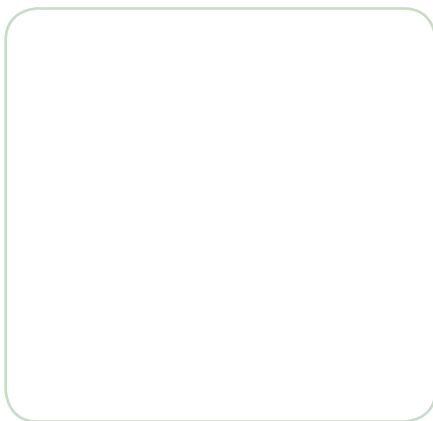

**AR-250**

**XS-250**

ISO

**XC-250**

VDI  
ISO

**PR-250**

**CS-250**

Flange must not support spring's force

**CF-250**

Flange must not support spring's force

VDI



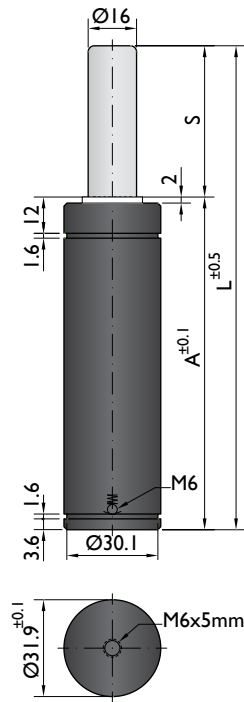

### Force / Pressure

		daN	bar (20°C)
V	GREEN	100	50
Z	BLUE	200	100
R	RED	250	125
A	YELLOW	300	150

\* maximum force if not specified

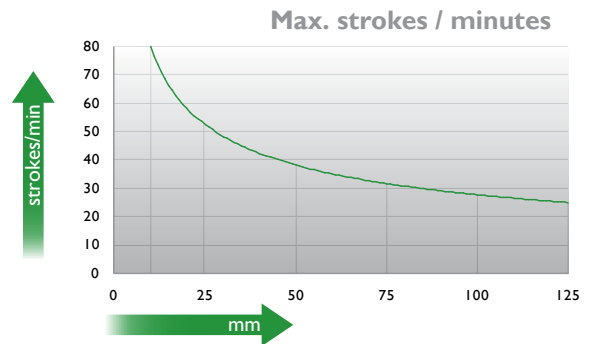

Ordering example: 4 x G-300-125 Z

Order No.	S <sup>(1)</sup> mm	L mm	A mm	F <sub>0</sub> <sup>(2)</sup> daN (20°C, 150 bar)	F daN		kg
G-300-12	12	84	72	300	340	No	0.28
G-300-25	25	110	85		370	No	0.33
G-300-38	38	136	98		380	No	0.37
G-300-50	50	160	110		390	No	0.41
G-300-63	63	186	123		420	No	0.49
G-300-80	80	220	140		430	No	0.56
G-300-100	100	260	160		440	No	0.64
G-300-125	125	310	185		450	No	0.74

other strokes <sup>(1)</sup> under request

alternative forces <sup>(2)</sup> upon request



Pressure medium	N <sub>2</sub>	Working temperature	0-80°C	Min. security stroke	10%
Max. Charging pressure	150 bar	Temperature related force increase	+0.34%/°C	Repair Kit	KIT G-300
Min. Charging pressure	25 bar	Max. working speed	1.6 m/s	Linkable	No

### Mounting possibilities

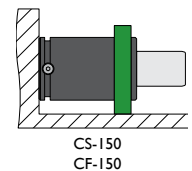
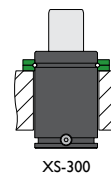
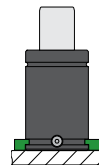
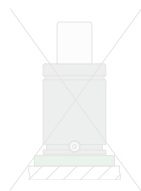
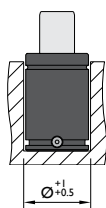
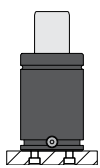

Flange must not support spring's force

## Flanges

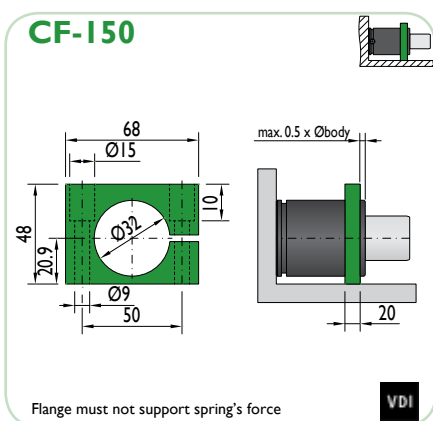
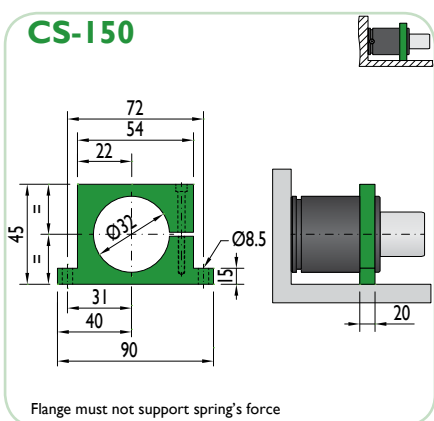
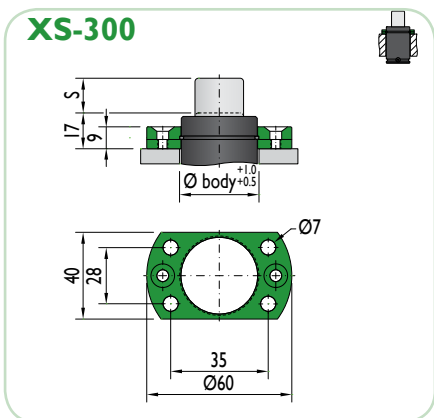
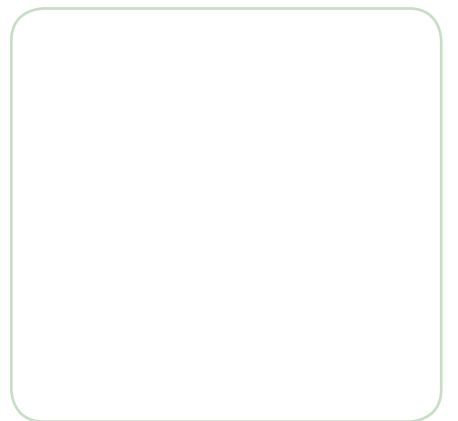
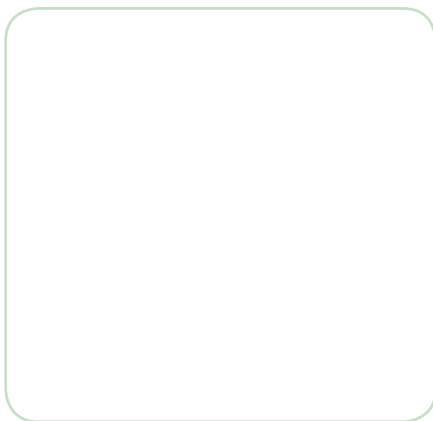
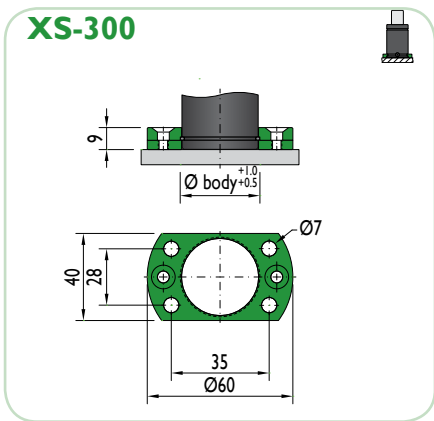



## Force 320 - 450 daN

### Piston Rod Sealed gas springs

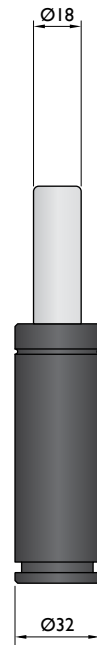
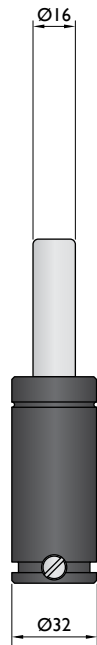
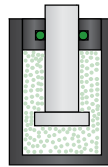

<b>Model</b>	KP-320	KP-350	NR-350	M-350
<b>Initial F (daN)</b>	320	360	360	350
<b>L max (mm)</b>	2xStroke+30	2xStroke+30	2xStroke+40	2xStroke+50
<b>Stroke (mm)</b>	7-125	10-125	10-125	15-125

\* other strokes under request

### Standards

**PED**  
97/23/EC

**ISO**  
11901

**VDI**  
3003

**CNOMO**  
EM24.54.700

**PED**  
97/23/EC

**ISO**  
11901

**VDI**  
3003

**CNOMO**  
EM24.54.700

**PED**  
97/23/EC

**ISO**  
11901

**VDI**  
3003

**CNOMO**  
EM24.54.700

**PED**  
97/23/EC

**ISO**  
11901

**VDI**  
3003

**CNOMO**  
EM24.54.700

## Force 320 - 450 daN

### Bore Sealed gas springs

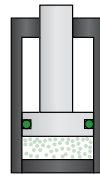

	T-420	TS-420
<b>Model</b>	T-420	TS-420
<b>Initial F (daN)</b>	420	420
<b>L max (mm)</b>	56-195	56-195
<b>Stroke (mm)</b>	6-50	6-50

\* other strokes under request

### Standards

**PED**  
97/23/EC

ISO  
11901

VDI  
3003

CNOMO  
EM24.54.700

**PED**  
97/23/EC

ISO  
11901

VDI  
3003

CNOMO  
EM24.54.700

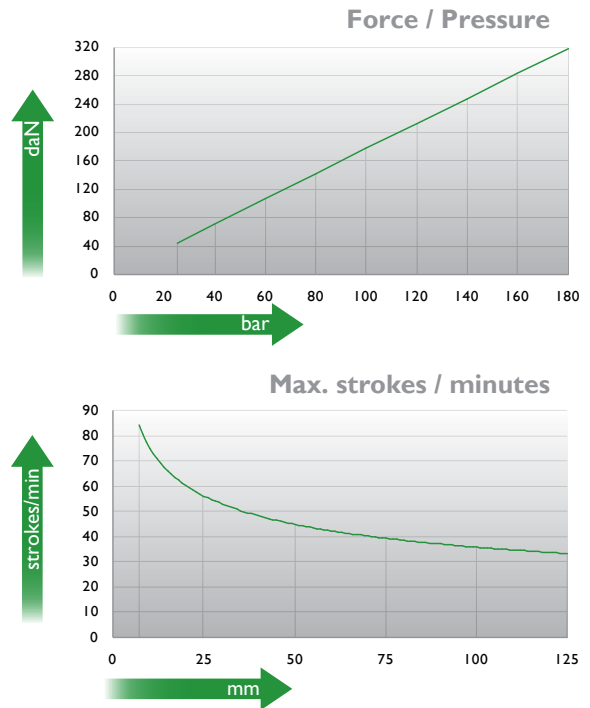
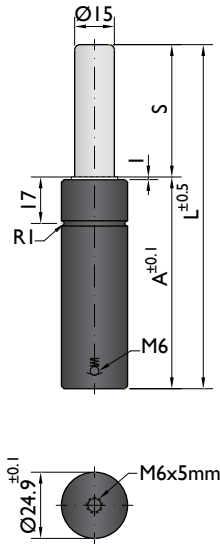

Ordering example: 4 x KP-320-125

Order No.	S <sup>(1)</sup> mm	L mm	A mm	F <sub>0</sub> <sup>(2)</sup> daN	F daN	kg
				(20°C, 180 bar)		
KP-320-7	7	44	37	320	450	0.09
KP-320-10	10	50	40		470	0.10
KP-320-15	15	60	45		500	0.11
KP-320-19	19	68	49		510	0.12
KP-320-25	25	80	55		530	0.13
KP-320-38	38	106	68		550	0.16
KP-320-50	50	130	80		560	0.19
KP-320-63	63	156	93		560	0.22
KP-320-75	75	185	110		560	0.24
KP-320-80	80	195	115		560	0.25
KP-320-100	100	235	135		560	0.30
KP-320-125	125	285	160		560	0.36

<sup>(1)</sup> other strokes under request      <sup>(2)</sup> alternative forces upon request



Pressure medium	N <sub>2</sub>	Working temperature	0-80°C	Min. security stroke	10%
Max. Charging pressure	180 bar	Temperature related force increase	+0.34%/°C	Repair Kit	Non-repairable
Min. Charging pressure	25 bar	Max. working speed	1.6 m/s	Linkable	No

### Mounting possibilities

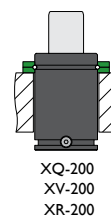
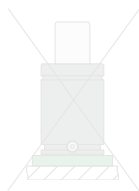
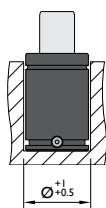
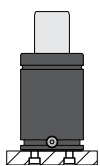

## Flanges



**XQ-200**

Technical drawing of the XQ-200 flange. The side view shows a height of 21.5 mm, a chamfered edge of 9 mm, and a total height of S mm. The body diameter is labeled as  $\text{Ø body} + 0.5$ . The top view shows an outer diameter of 50 mm ( $\text{Ø}50$ ), an inner diameter of 34 mm, and a thickness of 30 mm. There are four holes with a diameter of 7 mm ( $\text{Ø}7$ ). The ISO logo is present in the bottom right corner.

**XV-200**

Technical drawing of the XV-200 flange. The side view shows a height of 21.5 mm, a chamfered edge of 9 mm, and a total height of S mm. The body diameter is labeled as  $\text{Ø body} + 0.5$ . The top view shows an outer diameter of 50 mm ( $\text{Ø}50$ ), an inner diameter of 38 mm, and a thickness of 30 mm. There are four holes with a diameter of 7 mm ( $\text{Ø}7$ ). The VDI logo is present in the bottom right corner.

**XR-200**

Technical drawing of the XR-200 flange. The side view shows a height of 21.5 mm, a chamfered edge of 9 mm, and a total height of S mm. The body diameter is labeled as  $\text{Ø body} + 0.5$ . The top view shows an outer diameter of 50 mm ( $\text{Ø}50$ ), an inner diameter of 28 mm, and a thickness of 28 mm. There are four holes with a diameter of 7 mm ( $\text{Ø}7$ ).

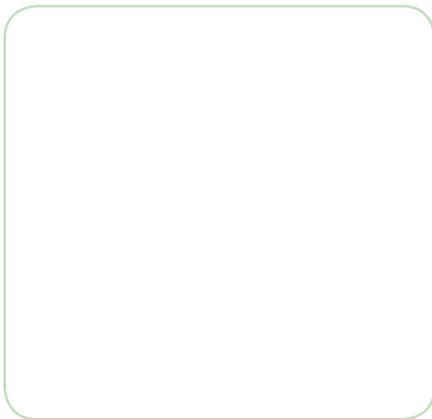

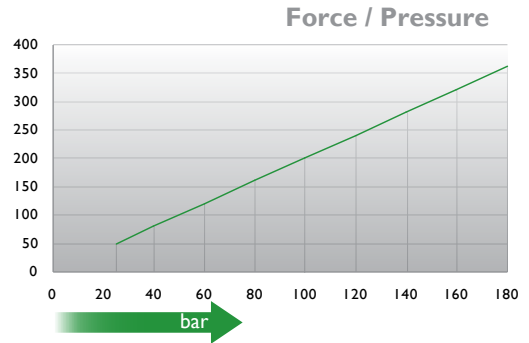
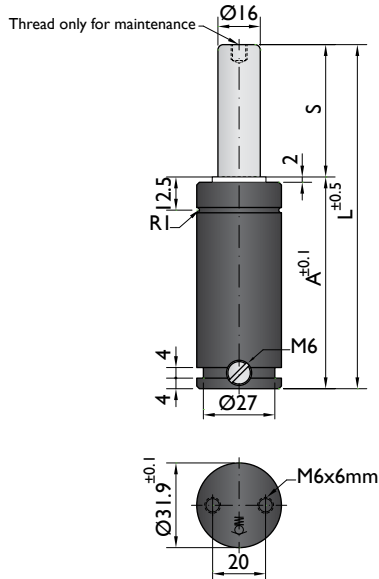

↑ daN

→ bar

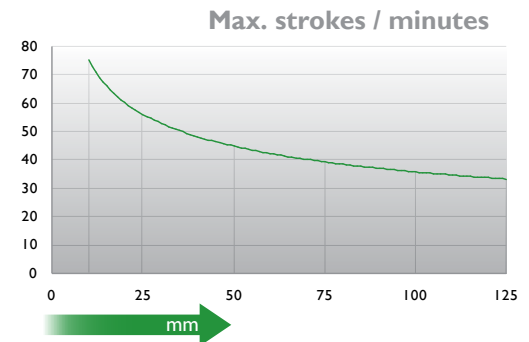

↑ strokes/min

→ mm

Ordering example: 4 x KP-350-125

Order No.	S <sup>(1)</sup> mm	L mm	A mm	F <sub>0</sub> <sup>(2)</sup> daN	F daN		kg
				(20°C, 180 bar)			
KP-350-10	10	50	40	360	520	No	0.16
KP-350-13	13	56	43		530	No	0.17
KP-350-16	16	62	46		530	No	0.18
KP-350-19	19	68	49		530	No	0.19
KP-350-25	25	80	55		530	No	0.21
KP-350-32	32	94	62		530	No	0.23
KP-350-38	38	106	68		530	No	0.25
KP-350-50	50	130	80		540	No	0.29
KP-350-63	63	156	93		540	No	0.33
KP-350-75	75	180	105		540	No	0.37
KP-350-80	80	190	110		540	No	0.38
KP-350-100	100	230	130		540	No	0.45
KP-350-125	125	280	155		540	No	0.53

<sup>(1)</sup> other strokes under request

<sup>(2)</sup> alternative forces upon request



Pressure medium	N <sub>2</sub>	Working temperature	0-80°C	Min. security stroke	10%
Max. Charging pressure	180 bar	Temperature related force increase	+0.34%/°C	Repair Kit	KIT KP-350
Min. Charging pressure	25 bar	Max. working speed	1.6 m/s	Linkable	M6

## Mounting possibilities

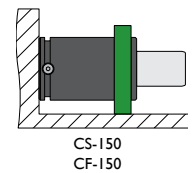
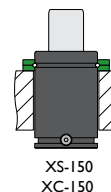
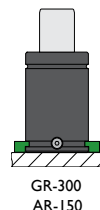
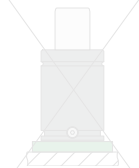
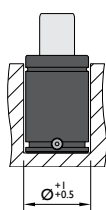
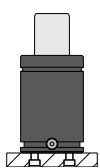

Flange must not support spring's force

## Flanges



**GR-300**

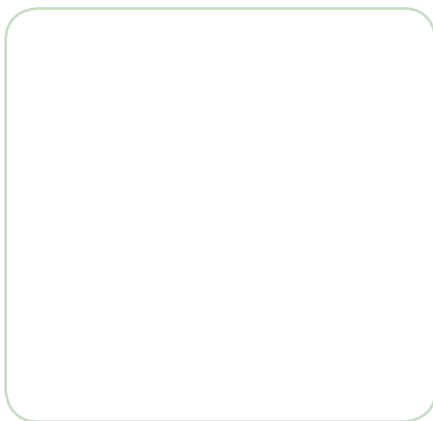

**AR-150**

**XS-150**

**XC-150**



**CS-150**

Flange must not support spring's force

**CF-150**

Flange must not support spring's force



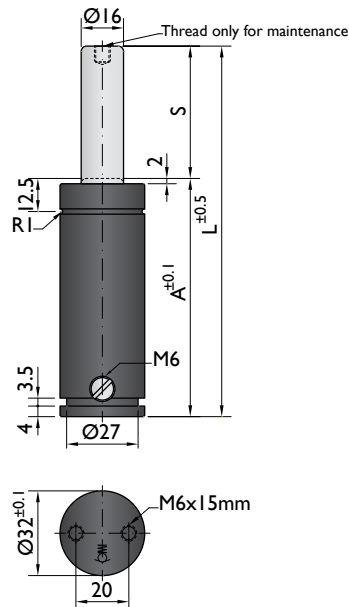

Force / Pressure

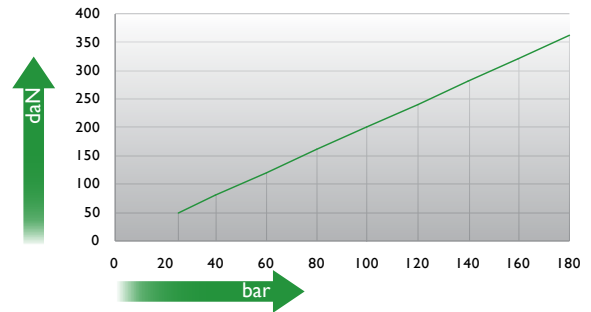

Max. strokes / minutes

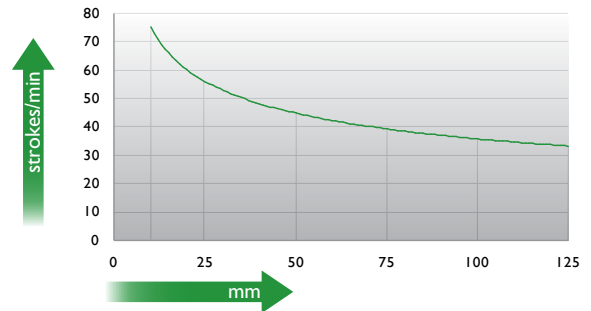

Ordering example: 4 x NR-350-125

Order No.	S <sup>(1)</sup> mm	L mm	A mm	F <sub>0</sub> <sup>(2)</sup> daN	F daN	kg
				(20°C, 180 bar)		
NR-350-10	10	60	50	360	530	0.23
NR-350-13	13	66	53		540	0.23
NR-350-16	16	72	56		540	0.24
NR-350-19	19	78	59		540	0.25
NR-350-25	25	90	65		540	0.27
NR-350-32	32	104	72		540	0.29
NR-350-38	38	116	78		540	0.31
NR-350-50	50	140	90		550	0.35
NR-350-63	63	166	103		550	0.39
NR-350-75	75	190	115		550	0.43
NR-350-80	80	200	120		550	0.44
NR-350-100	100	240	140		550	0.50
NR-350-125	125	290	165		550	0.58

<sup>(1)</sup> other strokes under request

<sup>(2)</sup> alternative forces upon request



Pressure medium	N <sub>2</sub>	Working temperature	0-80°C	Min. security stroke	10%
Max. Charging pressure	180 bar	Temperature related force increase	+0.34%/°C	Repair Kit	KIT NR-350
Min. Charging pressure	25 bar	Max. working speed	1.6 m/s	Linkable	M6

### Mounting possibilities

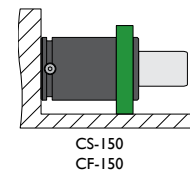
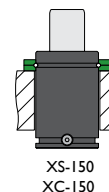
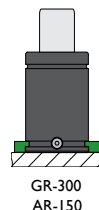
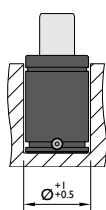
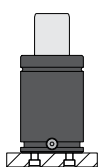

Flange must not support spring's force

## Flanges



**GR-300**

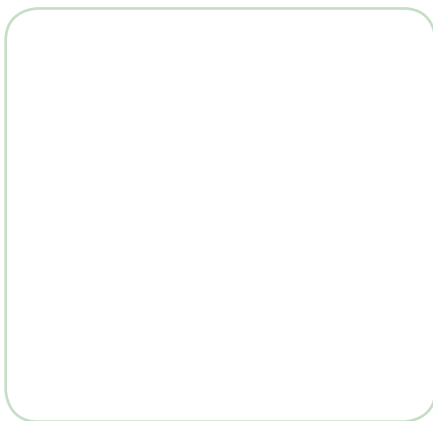

**AR-150**

**XS-150**

**XC-150**



**CS-150**

Flange must not support spring's force

**CF-150**

Flange must not support spring's force





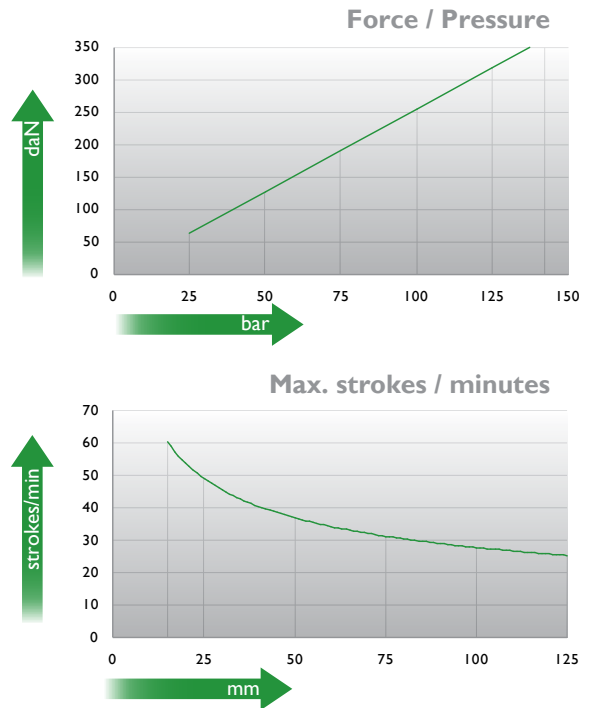
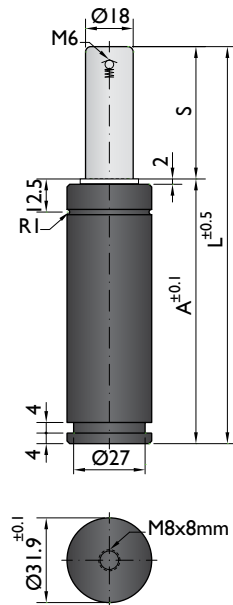

Ordering example: 4 x M-350-125

Order No.	S <sup>(1)</sup> mm	L mm	A mm	F <sub>0</sub> <sup>(2)</sup> daN	F daN	kg
M-350-15	15	80	65	350	520	0.31
M-350-25	25	100	75		540	0.34
M-350-38	38	126	88		550	0.38
M-350-50	50	150	100		560	0.42
M-350-63	63	176	113		570	0.47
M-350-80	80	210	130		570	0.53
M-350-100	100	250	150		580	0.62
M-350-125	125	300	175		580	0.71

other strokes <sup>(1)</sup> under request

alternative forces <sup>(2)</sup> upon request



Pressure medium	N <sub>2</sub>	Working temperature	0-80°C	Min. security stroke	10%
Max. Charging pressure	140 bar	Temperature related force increase	+0.34%/°C	Repair Kit	KIT M-350
Min. Charging pressure	25 bar	Max. working speed	1.6 m/s	Linkable	No

### Mounting possibilities

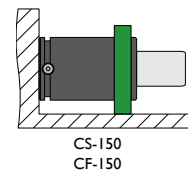
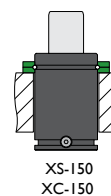
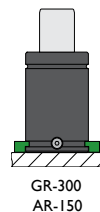
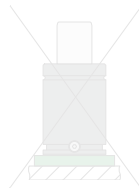
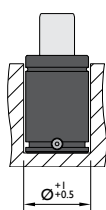
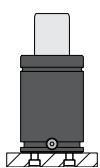

Flange must not support spring's force

## Flanges



**GR-300**

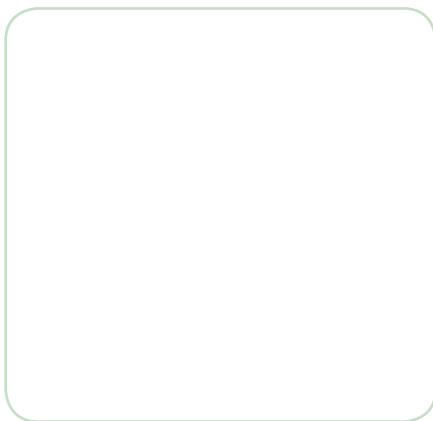

**AR-150**

**XS-150**

**XC-150**



**CS-150**

Flange must not support spring's force

**CF-150**

Flange must not support spring's force



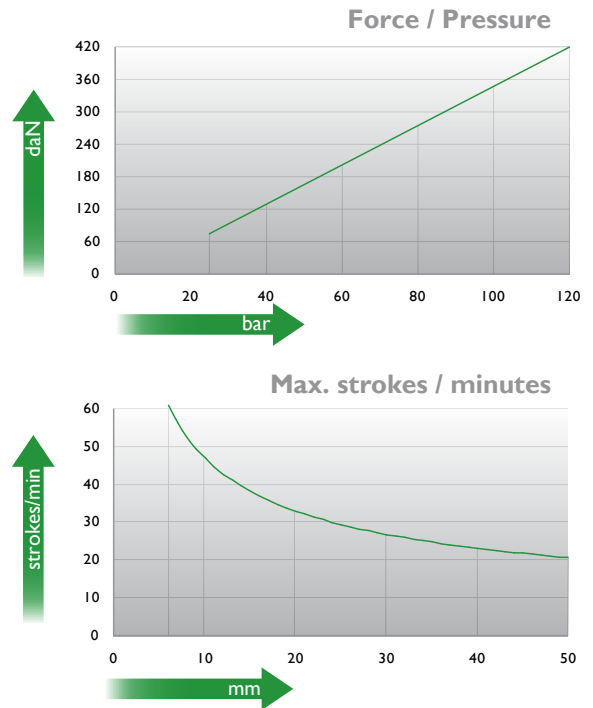
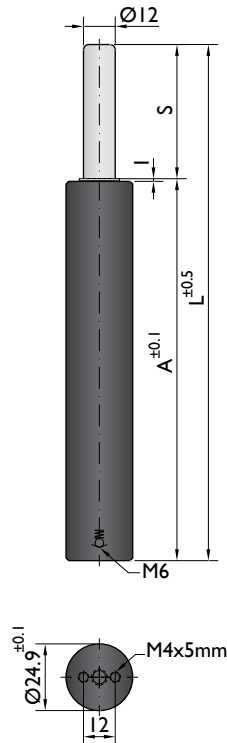

Ordering example: 4 x T-420-50

Order No.	S <sup>(1)</sup> mm	L mm	A mm	F <sub>0</sub> <sup>(2)</sup> daN (20°C, 120 bar)	F daN		kg
T-420-6	6	56	50	420	660	No	0.15
T-420-10	10	70	60		670	No	0.17
T-420-16	16	91	75		780	No	0.19
T-420-25	25	120	95		780	No	0.23
T-420-32	32	140	108		790	No	0.26
T-420-40	40	165	125		790	No	0.29
T-420-50	50	195	145		790	No	0.32

other strokes <sup>(1)</sup> under request

alternative forces <sup>(2)</sup> upon request



Pressure medium	N <sub>2</sub>	Working temperature	0-80°C	Min. security stroke	10%
Max. Charging pressure	120 bar	Temperature related force increase	+0.34%/°C	Repair Kit	Non-repairable
Min. Charging pressure	25 bar	Max. working speed	0.5 m/s	Linkable	No

### Mounting possibilities

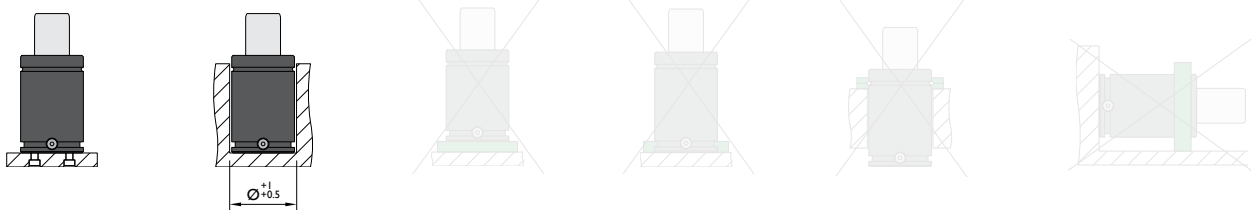

## Flanges

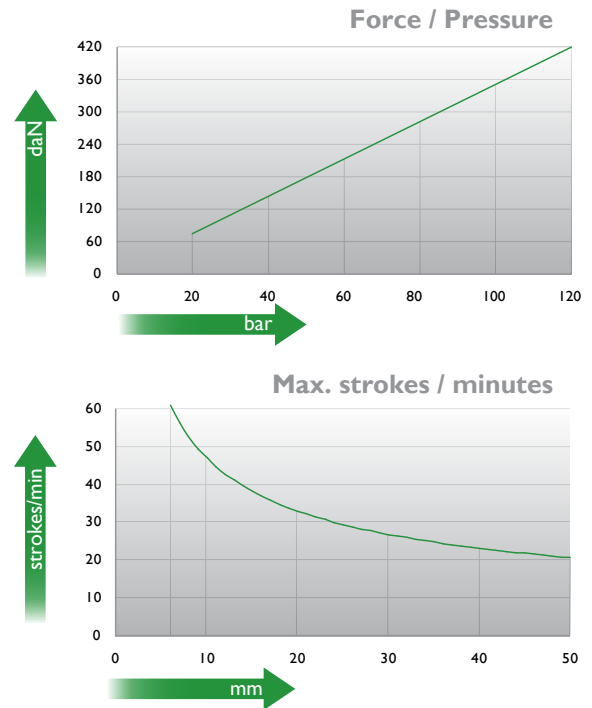
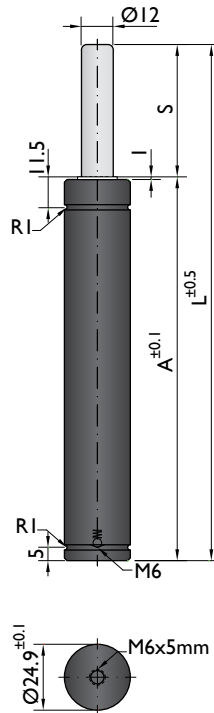

Ordering example: 4 x TS-420-50

Order No.	S <sup>(1)</sup> mm	L mm	A mm	F <sub>0</sub> <sup>(2)</sup> daN (20°C, 150 bar)	F daN		kg
TS-420-6	6	56	50	420	660	No	0.15
TS-420-10	10	70	60		670	No	0.17
TS-420-16	16	91	75		780	No	0.19
TS-420-25	25	120	95		780	No	0.23
TS-420-32	32	140	108		790	No	0.26
TS-420-40	40	165	125		790	No	0.29
TS-420-50	50	195	145		790	No	0.32

other strokes <sup>(1)</sup> under request

alternative forces <sup>(2)</sup> upon request



Pressure medium	N <sub>2</sub>	Working temperature	0-80°C	Min. security stroke	10%
Max. Charging pressure	120 bar	Temperature related force increase	+0.34%/°C	Repair Kit	Non-repairable
Min. Charging pressure	25 bar	Max. working speed	0.5 m/s	Linkable	No

### Mounting possibilities

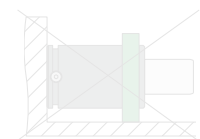
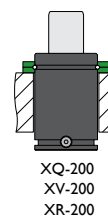
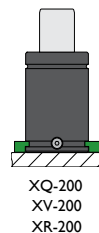
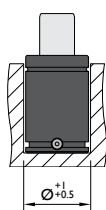
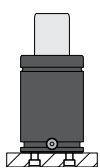

## Flanges



**XQ-200**

**XV-200**

**XR-200**

**XQ-200**

**XV-200**

**XR-200**

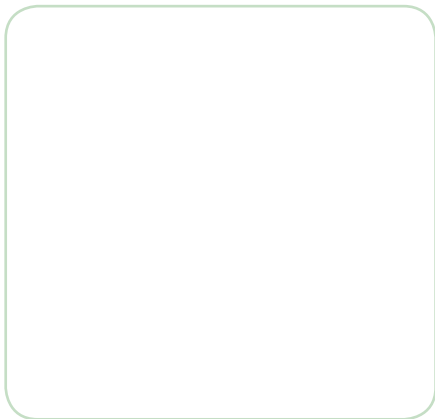
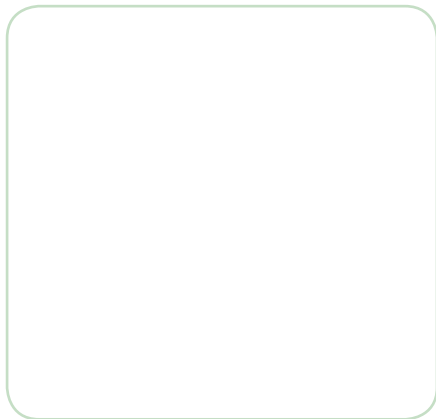

## Force 500 - 600 daN

### Piston Rod Sealed gas springs

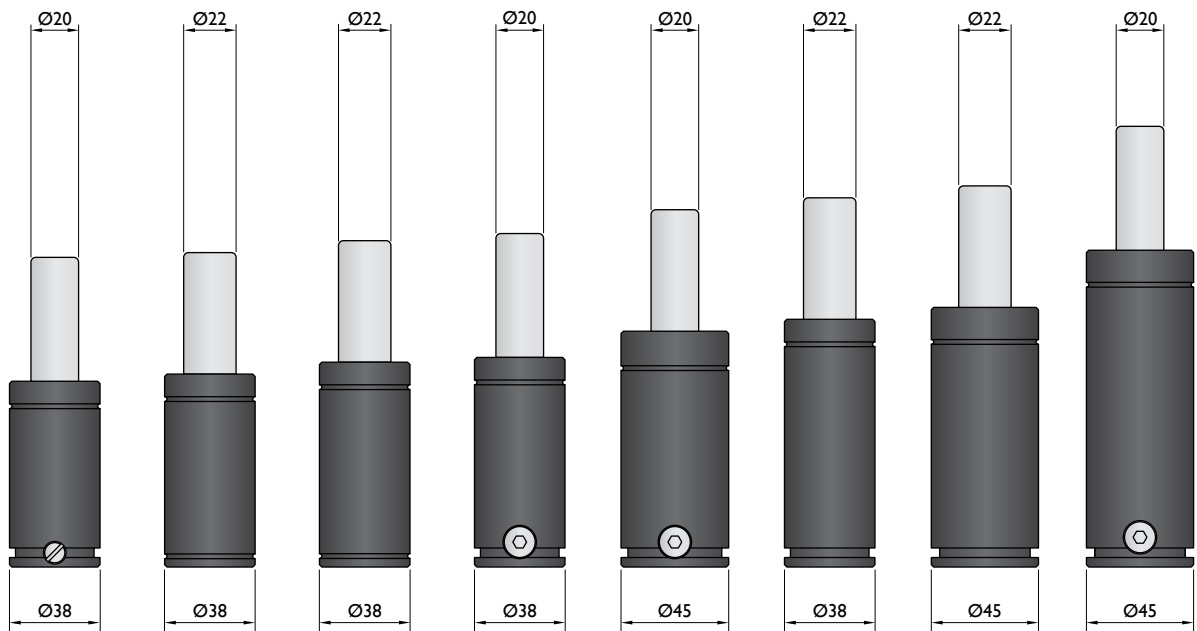
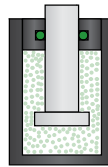

Model	KP-500	KC-550	K-570	NR-500	KH-500	M-500	G-500	CN-500
Initial F (daN)	470	550	570	470	470	500	500	470
L max (mm)	2xStroke+30	2xStroke+32	2xStroke+37	2xStroke+40	2xStroke+50	2xStroke+55	2xStroke+60	2xStroke+85
Stroke (mm)	10-125	12-125	7-125	10-125	12.7-125	12-125	12-125	12.7-160

\* other strokes under request

### Standards

PED 97/23/EC	PED 97/23/EC	PED 97/23/EC	PED 97/23/EC	PED 97/23/EC	PED 97/23/EC	PED 97/23/EC	PED 97/23/EC
ISO 11901	ISO 11901	ISO 11901	ISO 11901	ISO 11901	ISO 11901	ISO 11901	ISO 11901
VDI 3003	VDI 3003	VDI 3003	VDI 3003	VDI 3003	VDI 3003	VDI 3003	VDI 3003
CNOMO EM24.54.700	CNOMO EM24.54.700	CNOMO EM24.54.700	CNOMO EM24.54.700	CNOMO EM24.54.700	CNOMO EM24.54.700	CNOMO EM24.54.700	CNOMO EM24.54.700







PSA  
E24.54.815.G

Thread only for maintenance

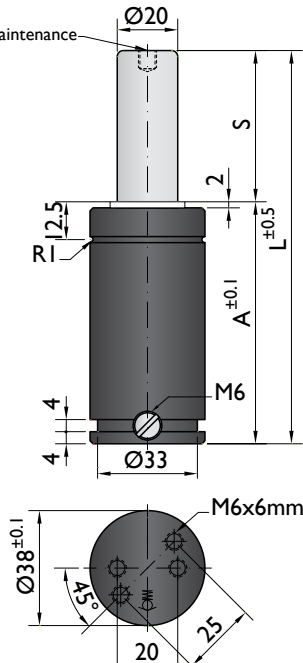

Force / Pressure

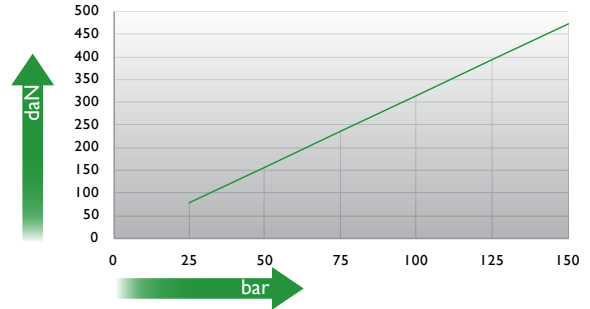

Max. strokes / minutes

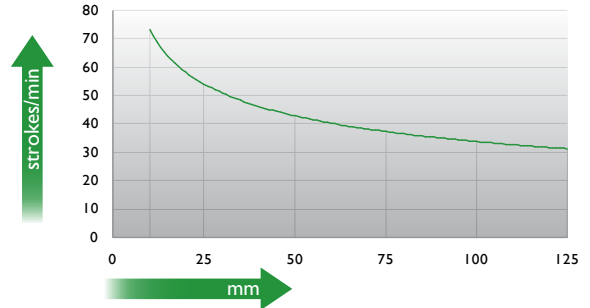

Ordering example: 4 x KP-500-125

Order No.	S <sup>(1)</sup> mm	L mm	A mm	F <sub>0</sub> <sup>(2)</sup> daN	F daN	kg
KP-500-10	10	50	40	470	680	0.29
KP-500-13	13	56	43		680	0.31
KP-500-16	16	62	46		690	0.34
KP-500-19	19	68	49		690	0.37
KP-500-25	25	80	55		690	0.42
KP-500-32	32	94	62		700	0.50
KP-500-38	38	106	68		700	0.55
KP-500-50	50	130	80		700	0.66
KP-500-63	63	156	93		710	0.80
KP-500-75	75	180	105		710	0.91
KP-500-80	80	190	110		710	0.98
KP-500-100	100	230	130		710	1.15
KP-500-125	125	280	155		710	1.38

<sup>(1)</sup> other strokes under request

<sup>(2)</sup> alternative forces upon request



Pressure medium	N <sub>2</sub>	Working temperature	0-80°C	Min. security stroke	10%
Max. Charging pressure	150 bar	Temperature related force increase	+0.34%/°C	Repair Kit	KIT KP-500
Min. Charging pressure	25 bar	Max. working speed	1.6 m/s	Linkable	M6

### Mounting possibilities

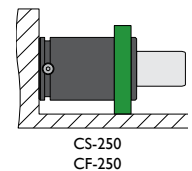
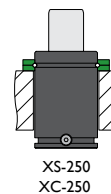
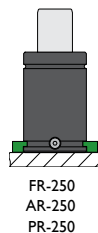
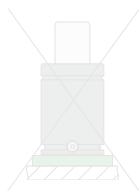
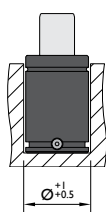
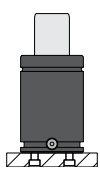

Flange must not support spring's force

## Flanges



**FR-250**

ISO

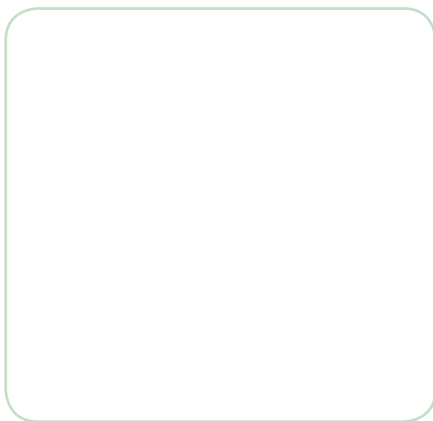

**AR-250**

**XS-250**

ISO

**XC-250**

VDI  
ISO

**PR-250**

**CS-250**

Flange must not support spring's force

**CF-250**

Flange must not support spring's force

VDI



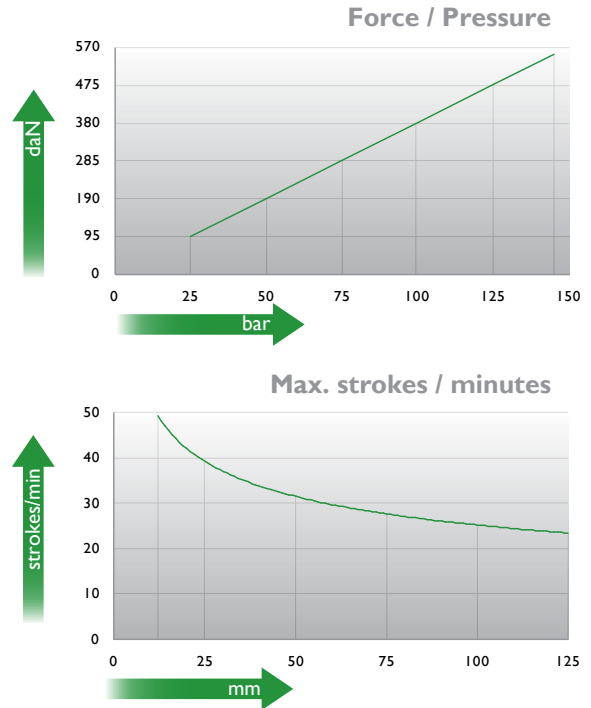
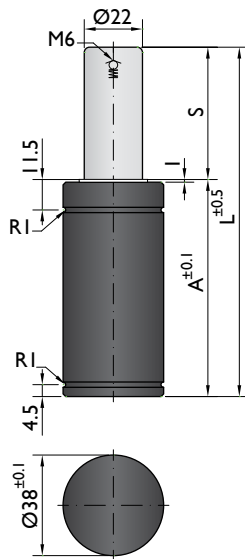

Ordering example: 4 x KC-550-125

Order No.	S <sup>(1)</sup> mm	L mm	A mm	F <sub>0</sub> <sup>(2)</sup> daN	F daN	kg
(20°C, 145 bar)						
KC-550-12	12	56	44	550	880	0.27
KC-550-25	25	82	57		890	0.31
KC-550-38	38	108	70		890	0.36
KC-550-50	50	132	82		890	0.42
KC-550-63	63	158	95		890	0.45
KC-550-80	80	192	112		890	0.51
KC-550-100	100	232	132		890	0.58
KC-550-125	125	282	157		890	0.63

<sup>(1)</sup> other strokes under request

<sup>(2)</sup> alternative forces upon request



Pressure medium	N <sub>2</sub>	Working temperature	0-80°C	Min. security stroke	10%
Max. Charging pressure	145 bar	Temperature related force increase	+0.34%/°C	Repair Kit	KIT KC-550
Min. Charging pressure	25 bar	Max. working speed	1.6 m/s	Linkable	No

### Mounting possibilities

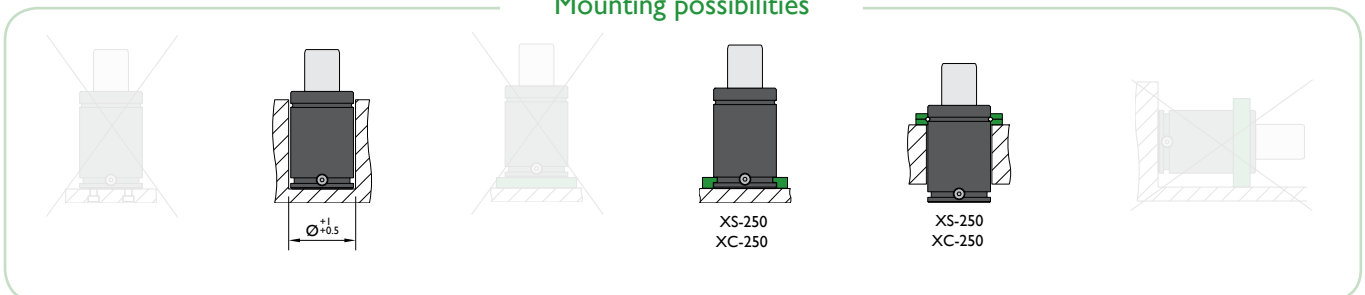

## Flanges



**XS-250**

**XC-250**

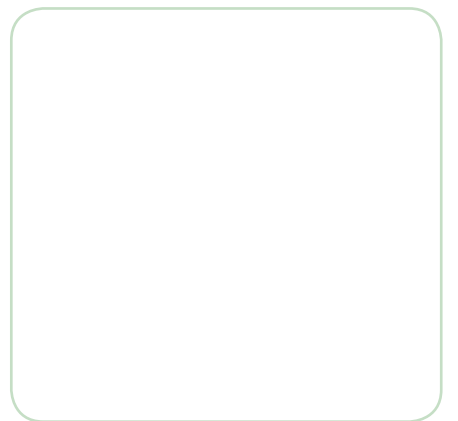

**XS-250**

**XC-250**

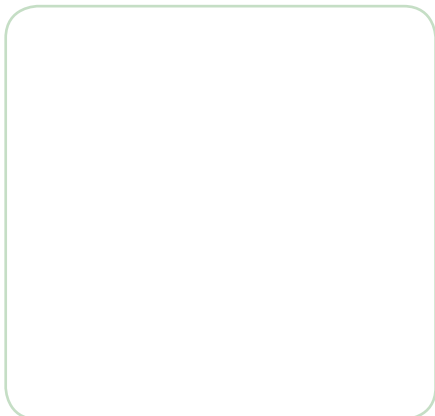

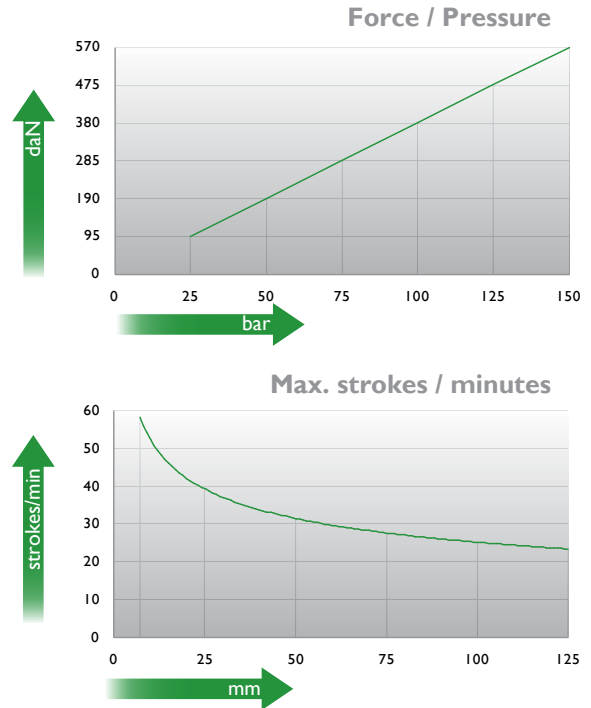
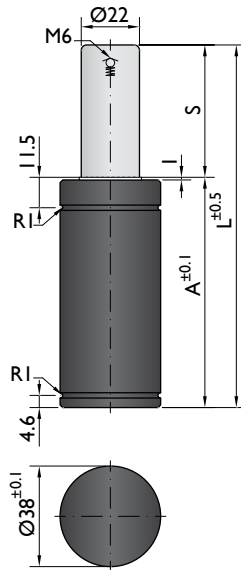

Ordering example: 4 x K-570-125

Order No.	S <sup>(1)</sup> mm	L mm	A mm	F <sub>0</sub> <sup>(2)</sup> daN	F daN	kg
K-570-7	7	51	44	570	830	0.26
K-570-12	12	61	49		860	0.31
K-570-16	16	69	53		870	0.33
K-570-25	25	87	62		890	0.36
K-570-38	38	113	75		900	0.41
K-570-50	50	137	87		910	0.47
K-570-63	63	163	100		910	0.50
K-570-80	80	197	117		910	0.60
K-570-100	100	237	137		920	0.69
K-570-125	125	287	162		920	0.75

<sup>(1)</sup> other strokes under request

<sup>(2)</sup> alternative forces upon request



Pressure medium	N <sub>2</sub>	Working temperature	0-80°C	Min. security stroke	10%
Max. Charging pressure	150 bar	Temperature related force increase	+0.34%/°C	Repair Kit	KIT K-570
Min. Charging pressure	25 bar	Max. working speed	1.6 m/s	Linkable	No

### Mounting possibilities

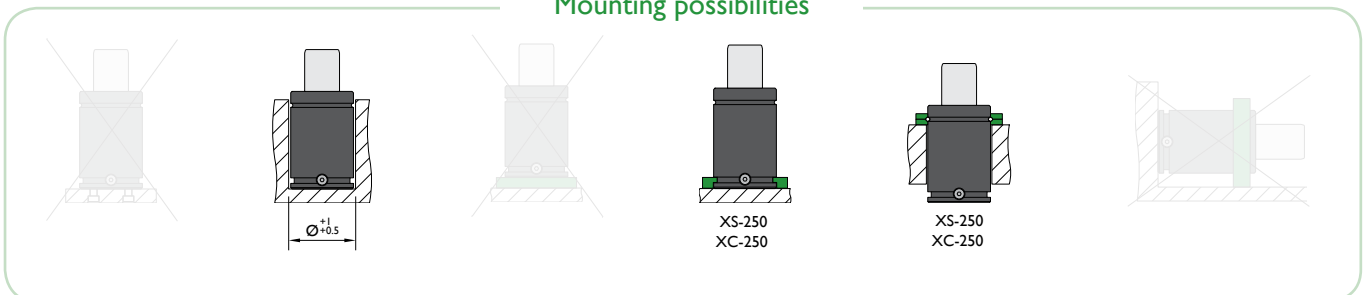

## Flanges

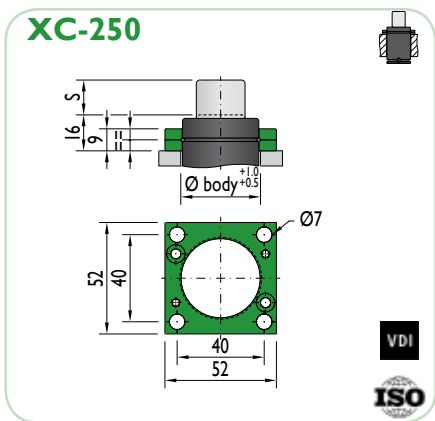
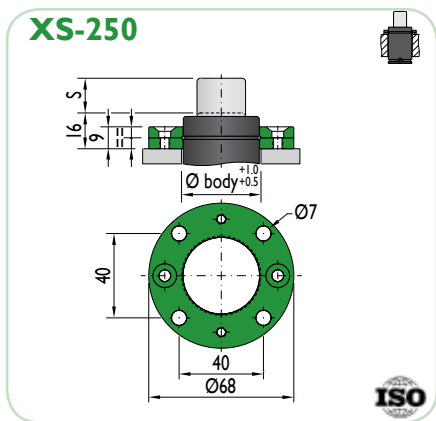
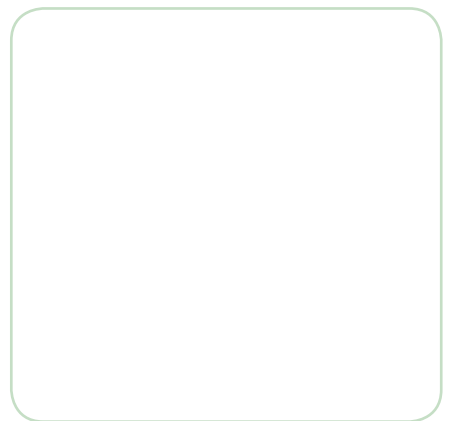
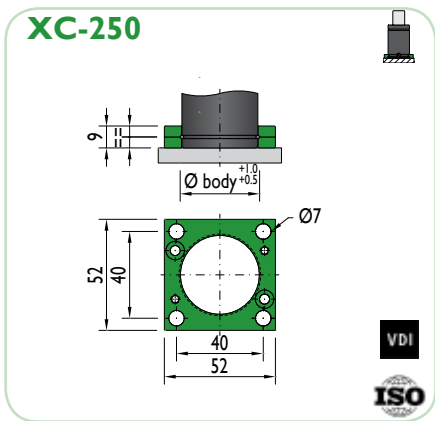
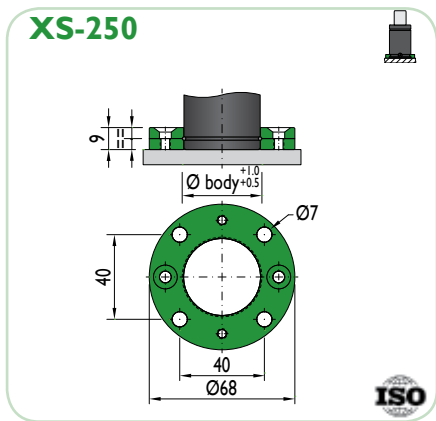



\*The new cylinder will be supplied when the stock runs out.

**NEW MODEL\***

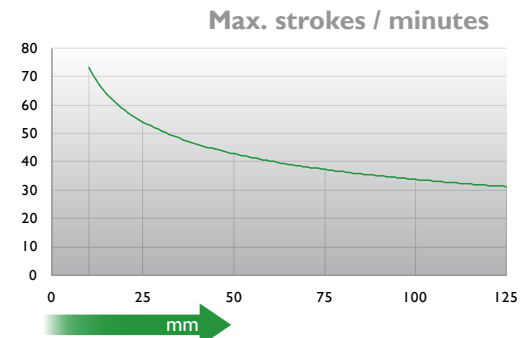
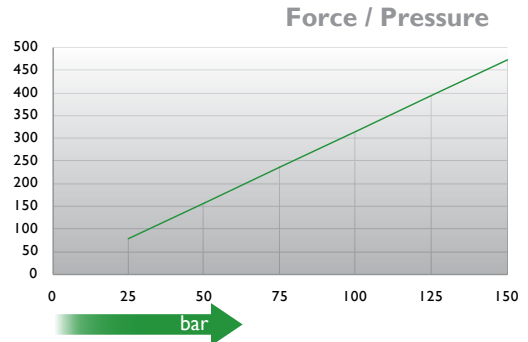
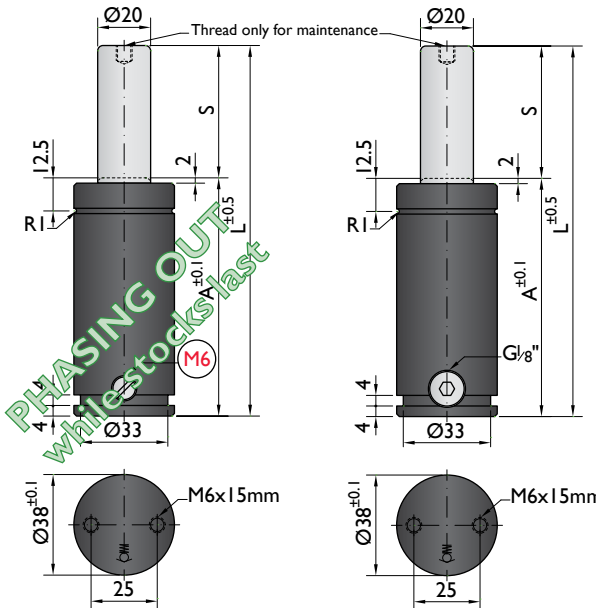

Ordering example: 4 x NR-500-125

Order No.	S <sup>(1)</sup> mm	L mm	A mm	F <sub>0</sub> <sup>(2)</sup> daN	F daN	kg
NR-500-10	10	60	50	470	690	0.34
NR-500-13	13	66	53		690	0.35
NR-500-16	16	72	56		700	0.37
NR-500-19	19	78	59		700	0.38
NR-500-25	25	90	65		700	0.40
NR-500-32	32	104	72		710	0.42
NR-500-38	38	116	78		710	0.45
NR-500-50	50	140	90		710	0.50
NR-500-63	63	166	103		720	0.54
NR-500-75	75	190	115		720	0.58
NR-500-80	80	200	120		720	0.60
NR-500-100	100	240	140		720	0.69
NR-500-125	125	290	165		720	0.78

<sup>(1)</sup> other strokes under request

<sup>(2)</sup> alternative forces upon request



Pressure medium	N <sub>2</sub>	Working temperature	0-80°C	Min. security stroke	10%
Max. Charging pressure	150 bar	Temperature related force increase	+0.34%/°C	Repair Kit	KIT NR-500
Min. Charging pressure	25 bar	Max. working speed	1.6 m/s	Linkable	G1/8"

**Mounting possibilities**

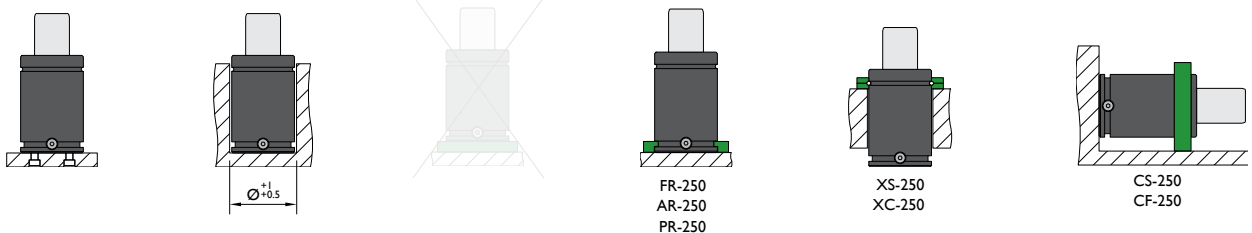

Flange must not support spring's force

## Flanges



**FR-250**

ISO

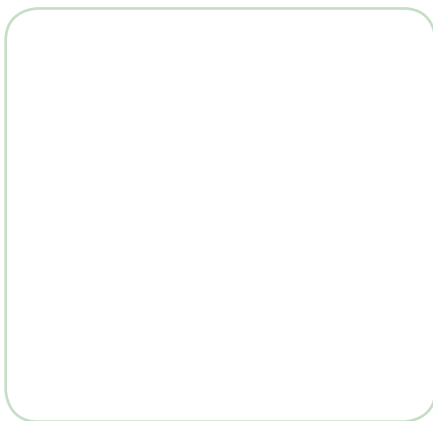

**AR-250**

**XS-250**

ISO

**XC-250**

VDI  
ISO

**PR-250**

**CS-250**

Flange must not support spring's force

**CF-250**

Flange must not support spring's force

VDI





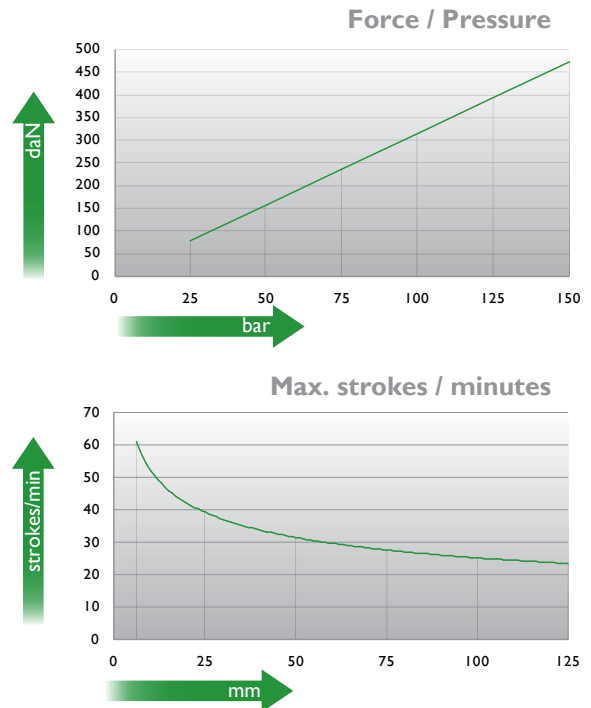
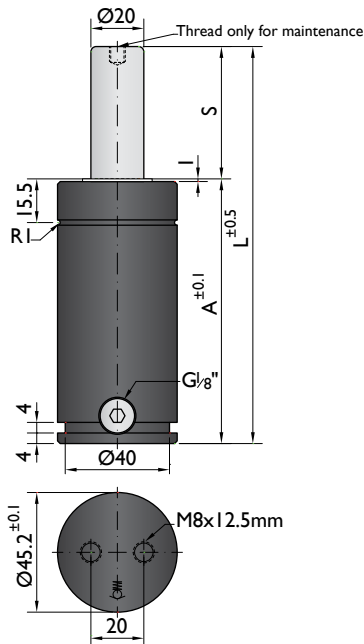

Ordering example: 4 x KH-500-125

Order No.	S <sup>(1)</sup> mm	L mm	A mm	F <sub>0</sub> <sup>(2)</sup> daN (20°C, 150 bar)	F daN		kg
KH-500-13	12.7	75.4	62.7	470	600	No	0.55
KH-500-19	19	88	69		610	No	0.59
KH-500-25	25	100	75		620	No	0.63
KH-500-38	38.1	126.2	88.1		620	No	0.71
KH-500-50	50	150	100		630	No	0.80
KH-500-63	63.5	177	113.5		640	No	0.87
KH-500-80	80	210	130		660	No	0.97
KH-500-100	100	250	150		660	No	1.11
KH-500-125	125	300	175		660	No	1.25

<sup>(1)</sup> other strokes under request

<sup>(2)</sup> alternative forces upon request



Pressure medium	N <sub>2</sub>	Working temperature	0-80°C	Min. security stroke	10%
Max. Charging pressure	150 bar	Temperature related force increase	+0.34%/°C	Repair Kit	KIT KH-500
Min. Charging pressure	25 bar	Max. working speed	1.6 m/s	Linkable	G1/8"

### Mounting possibilities

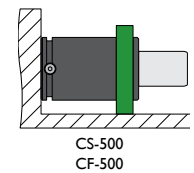
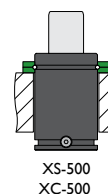
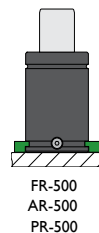
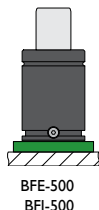
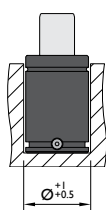
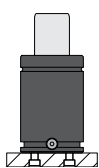

Flange must not support spring's force

## Flanges

**BFE-500**

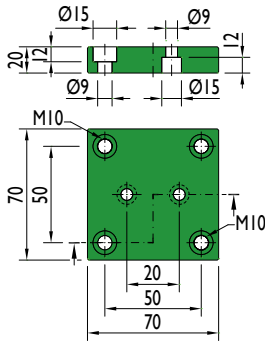

**BFI-500**

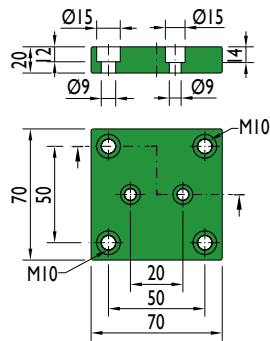

**FR-500**

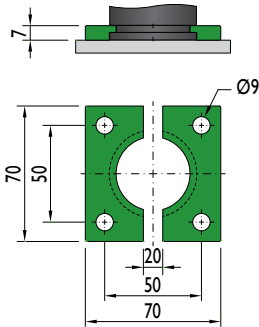

**AR-500**

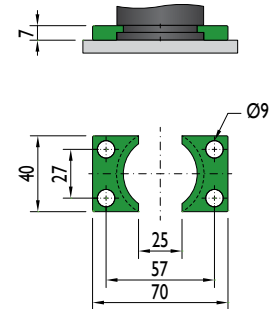

**XS-500**

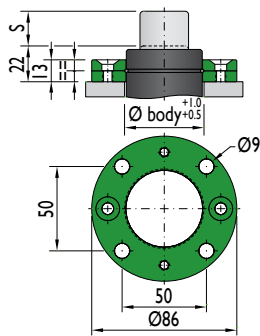

**XC-500**

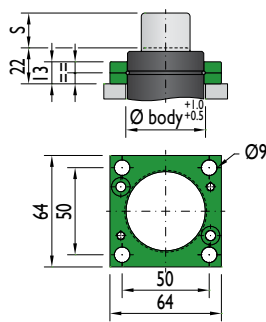

**PR-500**

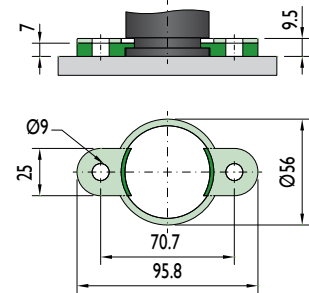

**CS-500**

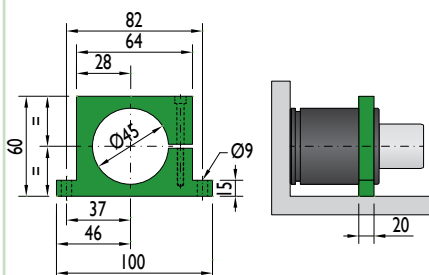

Flange must not support spring's force

**CF-500**

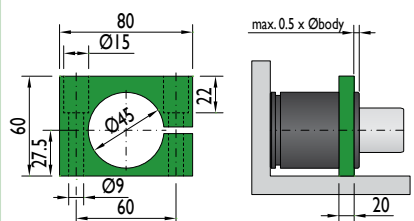

Flange must not support spring's force

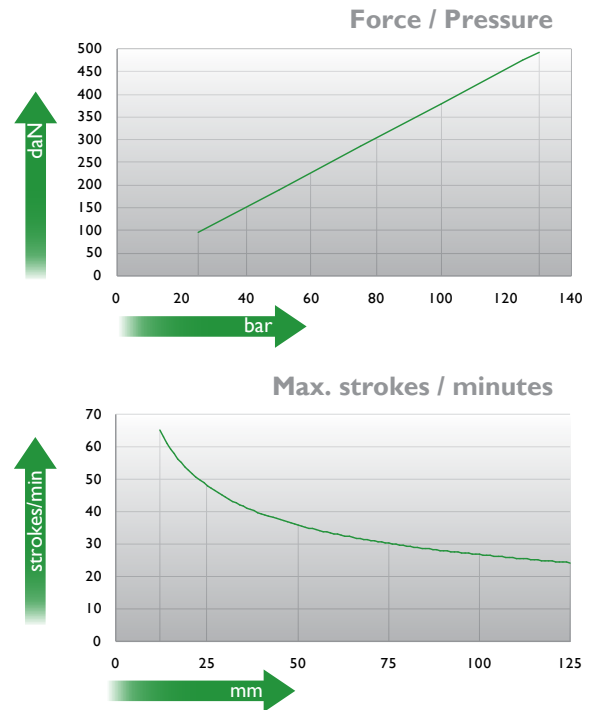
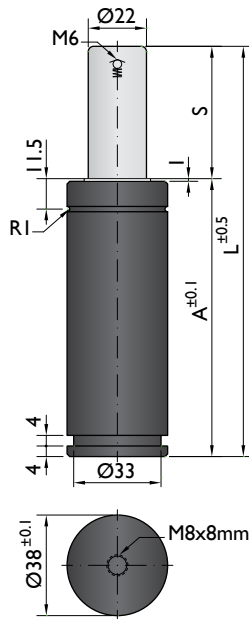

Ordering example: 4 x M-500-125

Order No.	S <sup>(1)</sup> mm	L mm	A mm	F <sub>0</sub> <sup>(2)</sup> daN	F daN	kg
M-500-12	12	79	67	500 (20°C, 130 bar)	650	0.43
M-500-15	15	85	70		670	0.45
M-500-25	25	105	80		700	0.48
M-500-38	38	131	93		730	0.55
M-500-50	50	155	105		740	0.58
M-500-63	63	186	123		740	0.66
M-500-80	80	220	140		740	0.72
M-500-100	100	260	160		750	0.80
M-500-125	125	310	185		750	0.91

<sup>(1)</sup> other strokes under request

<sup>(2)</sup> alternative forces upon request



Pressure medium	N <sub>2</sub>	Working temperature	0-80°C	Min. security stroke	10%
Max. Charging pressure	130 bar	Temperature related force increase	+0.34%/°C	Repair Kit	KIT M-500
Min. Charging pressure	25 bar	Max. working speed	1.6 m/s	Linkable	No

### Mounting possibilities

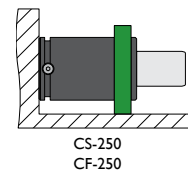
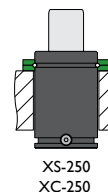
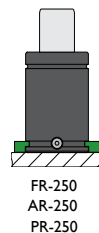
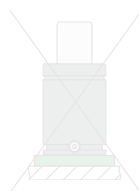
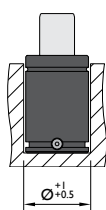
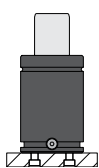

Flange must not support spring's force

## Flanges



**FR-250**

ISO

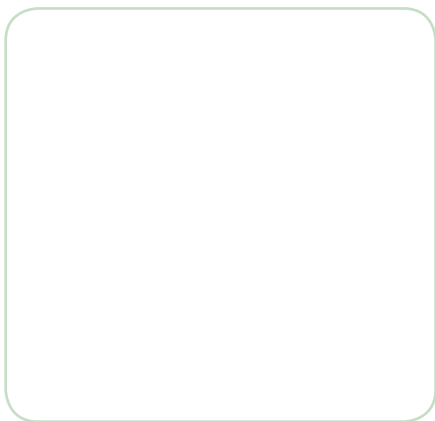

**AR-250**

**XS-250**

ISO

**XC-250**

VDI  
ISO

**PR-250**

**CS-250**

Flange must not support spring's force

**CF-250**

Flange must not support spring's force

VDI

Special mounts available on  
[www.nitrogas.com](http://www.nitrogas.com)

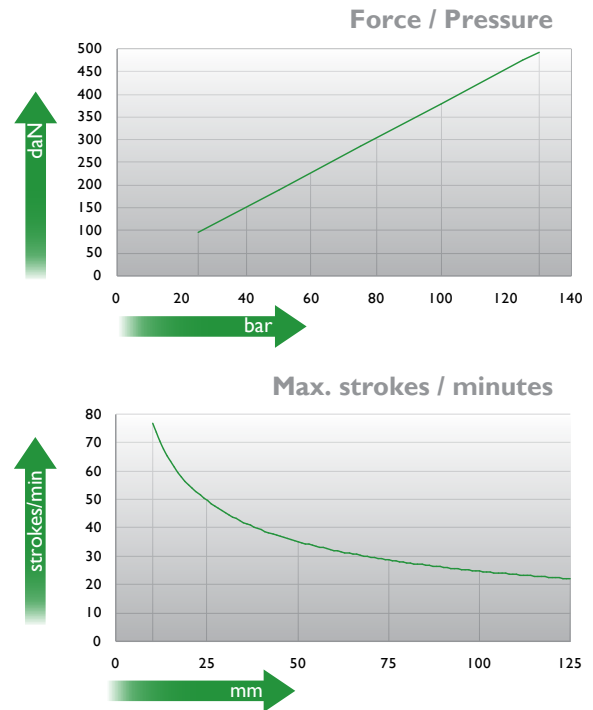
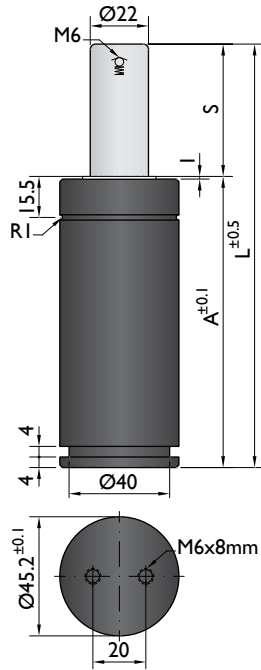

Ordering example: 4 x G-500-125

Order No.	S <sup>(1)</sup> mm	L mm	A mm	F <sub>0</sub> <sup>(2)</sup> daN (20°C, 130 bar)	F daN		kg
G-500-12	12	84	72	500	610	No	0.66
G-500-25	25	110	85		670	No	0.77
G-500-38	38	136	98		700	No	0.88
G-500-50	50	160	110		720	No	0.91
G-500-63	63	186	123		730	No	1.00
G-500-80	80	220	140		740	No	1.12
G-500-100	100	260	160		750	No	1.45
G-500-125	125	310	185		800	No	1.85

<sup>(1)</sup> other strokes under request

<sup>(2)</sup> alternative forces upon request



Pressure medium	N <sub>2</sub>	Working temperature	0-80°C	Min. security stroke	10%
Max. Charging pressure	130 bar	Temperature related force increase	+0.34%/°C	Repair Kit	KIT G-500
Min. Charging pressure	25 bar	Max. working speed	1.6 m/s	Linkable	No

### Mounting possibilities

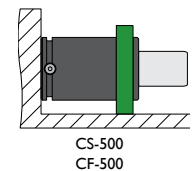
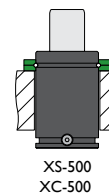
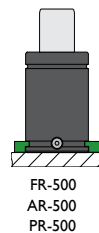
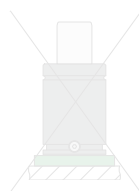
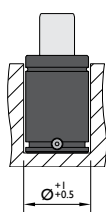
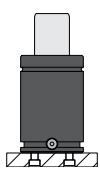

Flange must not support spring's force

## Flanges

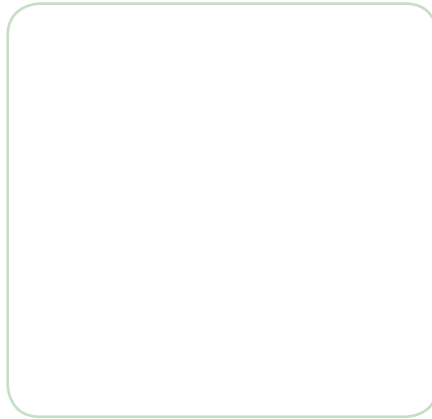

**FR-500**

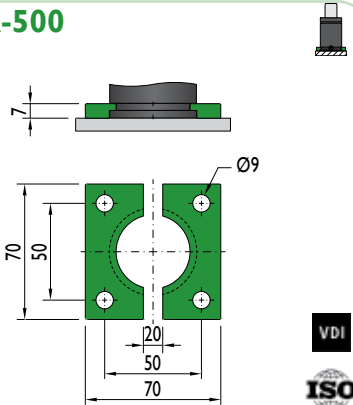

**AR-500**

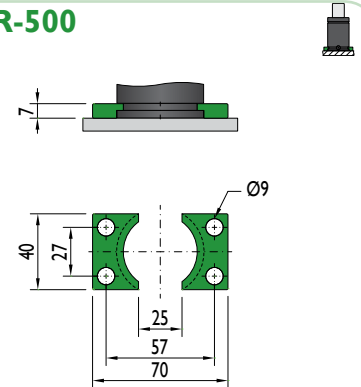

**XS-500**

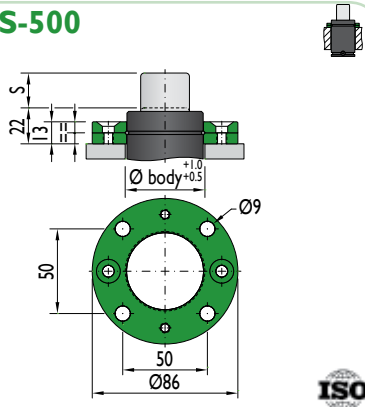

**XC-500**

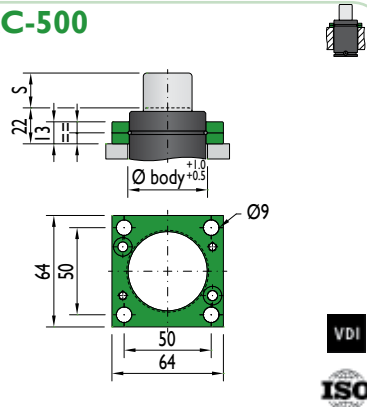

**PR-500**

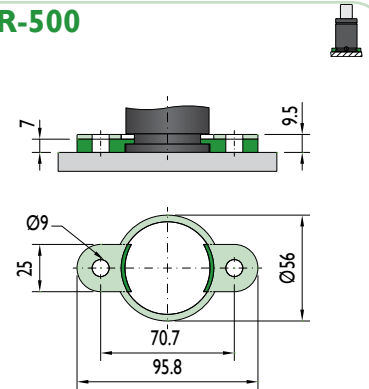

**CS-500**

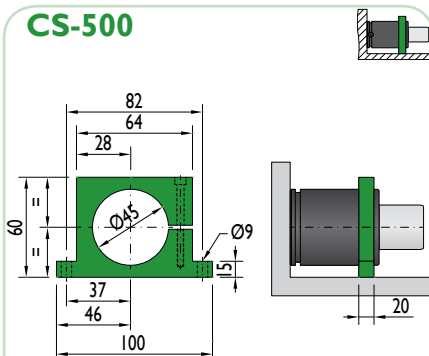

**CF-500**

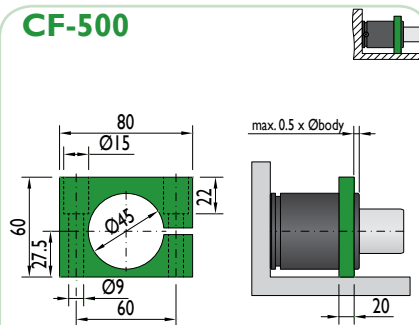

Flange must not support spring's force

Flange must not support spring's force

Special mounts available on  
[www.nitrogas.com](http://www.nitrogas.com)



CNOMO  
EM24.54.700

PSA  
E24.54.815.G

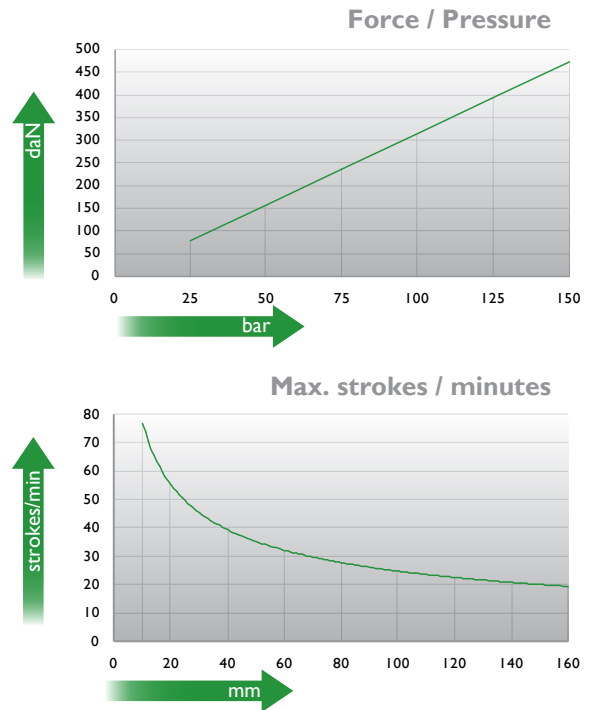
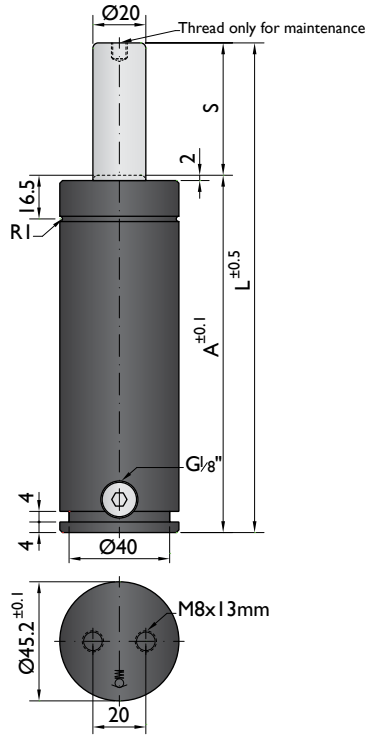

Ordering example: 4 x CN-500-125

Order No.	S <sup>(1)</sup> mm	L mm	A mm	F <sub>0</sub> <sup>(2)</sup> daN (20°C, 150 bar)	F daN	kg
CN-500-13	12.7	110.4	97.7		540	0.73
CN-500-25	25	135	110		580	0.87
CN-500-38	38.1	161.2	123.1		610	0.96
CN-500-50	50	185	135		620	1.06
CN-500-63	63.5	212	148.5	470	630	1.18
CN-500-80	80	245	165		650	1.34
CN-500-100	100	285	185		670	1.50
CN-500-125	125	335	210		680	1.72
CN-500-160	160	405	245		690	2.03

<sup>(1)</sup> other strokes under request

<sup>(2)</sup> alternative forces upon request



Pressure medium	N <sub>2</sub>	Working temperature	0-80°C	Min. security stroke	10%
Max. Charging pressure	150 bar	Temperature related force increase	+0.34%/°C	Repair Kit	KIT CN-500
Min. Charging pressure	25 bar	Max. working speed	1.6 m/s	Linkable	G1/8"

## Mounting possibilities

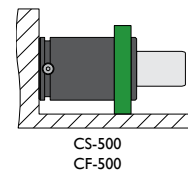
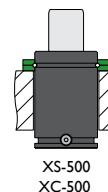
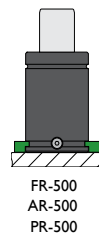
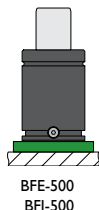
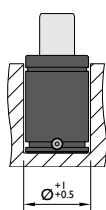
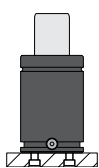

Flange must not support spring's force

## Flanges

**BFE-500**

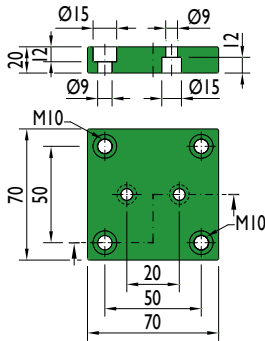

**BFI-500**

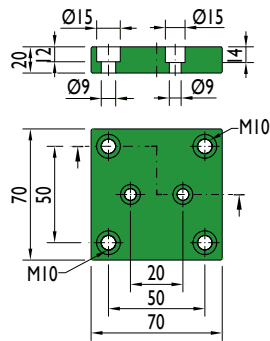

**FR-500**

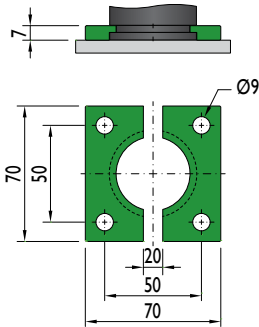

**AR-500**

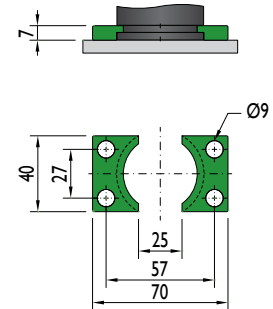

**XS-500**

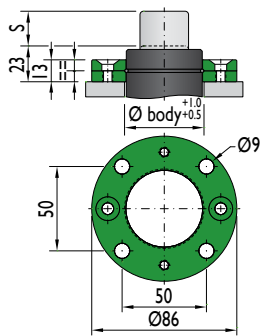

**XC-500**

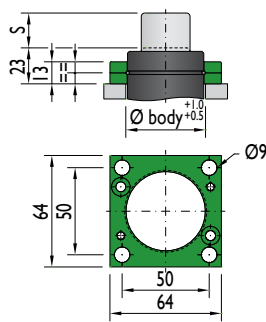

**PR-500**

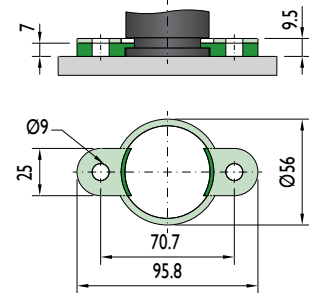

**CS-500**

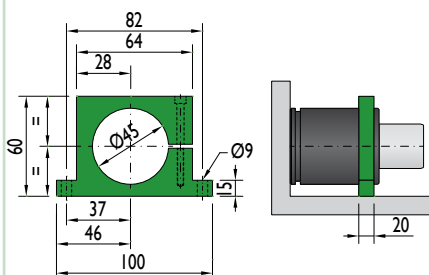

Flange must not support spring's force

**CF-500**

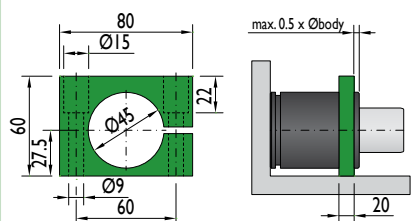

Flange must not support spring's force





## Force 750 daN

### Piston Rod Sealed gas springs

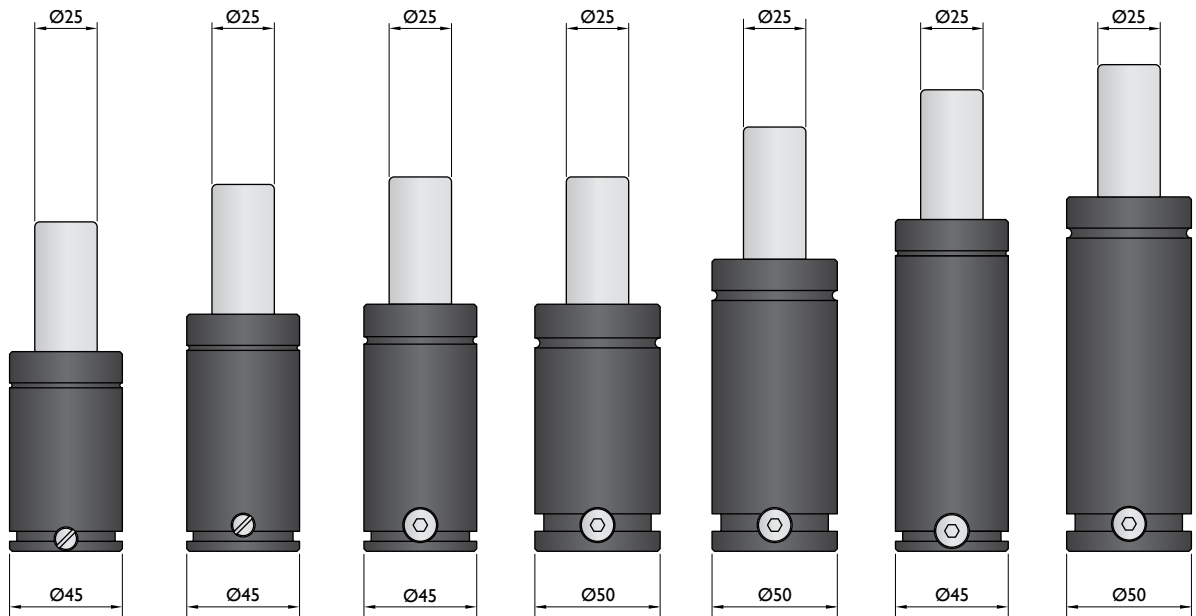
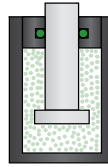

<b>Model</b>	<b>KP-750</b>	<b>NR-750</b>	<b>K-750</b>	<b>KH-750</b>	<b>HG-750</b>	<b>HD-750</b>	<b>G-750</b>
<b>Initial F (daN)</b>	740	740	740	740	740	740	740
<b>L max (mm)</b>	2xStroke+32	2xStroke+47	2xStroke+50	2xStroke+50	2xStroke+70	2xStroke+85	2xStroke+95
<b>Stroke (mm)</b>	10-125	10-125	12-125	12.7-125	12.5-200	13-200	12.7-300
			* other strokes under request				

### Standards

<b>PED</b> 97/23/EC	<b>PED</b> 97/23/EC	<b>PED</b> 97/23/EC	<b>PED</b> 97/23/EC	<b>PED</b> 97/23/EC	<b>PED</b> 97/23/EC	<b>PED</b> 97/23/EC
<b>ISO</b> 11901	<b>ISO</b> 11901	<b>ISO</b> 11901	<b>ISO</b> 11901	<b>ISO</b> 11901	<b>ISO</b> 11901	<b>ISO</b> 11901
<b>VDI</b> 3003	<b>VDI</b> 3003	<b>VDI</b> 3003	<b>VDI</b> 3003	<b>VDI</b> 3003	<b>VDI</b> 3003	<b>VDI</b> 3003
<b>CNOMO</b> EM24.54.700	<b>CNOMO</b> EM24.54.700	<b>CNOMO</b> EM24.54.700	<b>CNOMO</b> EM24.54.700	<b>CNOMO</b> EM24.54.700	<b>CNOMO</b> EM24.54.700	<b>CNOMO</b> EM24.54.700

## Force 750 daN

### Bore Sealed gas springs

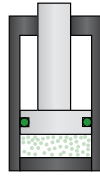

	T-750	TS-750
<b>Model</b>	T-750	TS-750
<b>Initial F (daN)</b>	740	740
<b>L max (mm)</b>	63-195	63-195
<b>Stroke (mm)</b>	6-50	6-50

\* other strokes under request

### Standards

**PED**  
97/23/EC

ISO  
11901

VDI  
3003

CNOMO  
EM24.54.700

**PED**  
97/23/EC

ISO  
11901

VDI  
3003

CNOMO  
EM24.54.700

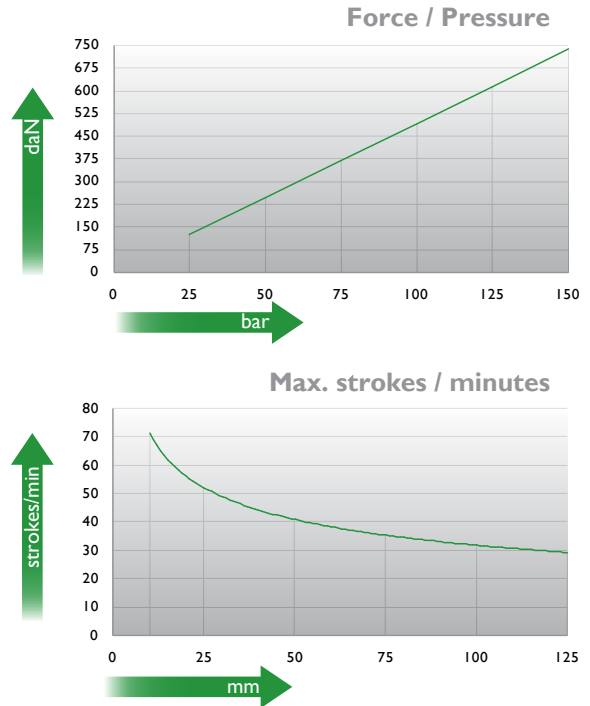
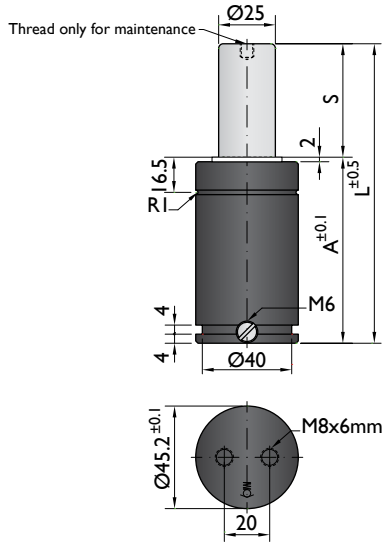

Ordering example: 4 x KP-750-125

Order No.	S <sup>(1)</sup> mm	L mm	A mm	F <sub>0</sub> <sup>(2)</sup> daN (20°C, 150 bar)	F daN		kg
KP-750-10	10	52	42	740	1000	No	0.33
KP-750-13	13	58	45		1000	No	0.41
KP-750-16	16	64	48		1000	No	0.42
KP-750-19	19	70	51		1100	No	0.44
KP-750-25	25	82	57		1100	No	0.45
KP-750-32	32	96	64		1100	No	0.50
KP-750-38	38	108	70		1100	No	0.58
KP-750-50	50	132	82		1100	Yes	0.67
KP-750-63	63	158	95		1100	Yes	0.75
KP-750-75	75	182	107		1100	Yes	0.84
KP-750-80	80	192	112		1100	Yes	0.87
KP-750-100	100	232	132		1100	Yes	1.01
KP-750-125	125	282	157	1100	Yes	1.18	

other strokes <sup>(1)</sup> under request

alternative forces <sup>(2)</sup> upon request

ESK available for other strokes <sup>(3)</sup>



Pressure medium	N <sub>2</sub>	Working temperature	0-80°C	Min. security stroke	10%
Max. Charging pressure	150 bar	Temperature related force increase	+0.34%/°C	Repair Kit	KIT KP-750
Min. Charging pressure	25 bar	Max. working speed	1.6 m/s	Linkable	M6

## Mounting possibilities

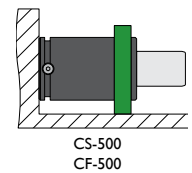
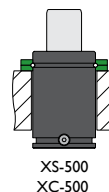
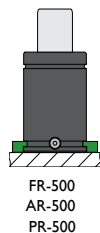
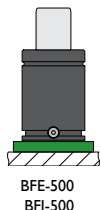
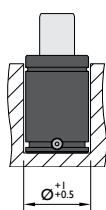
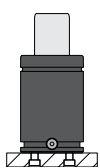

Flange must not support spring's force

## Flanges

**BFE-500**

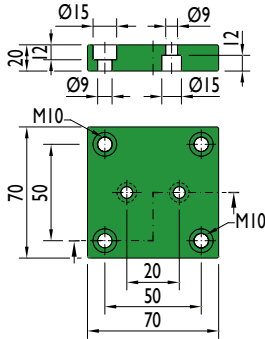

**BFI-500**

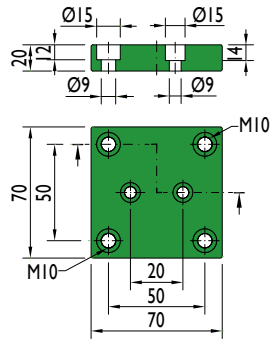

**FR-500**

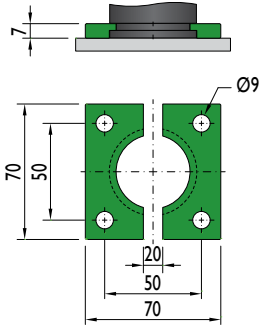

**AR-500**

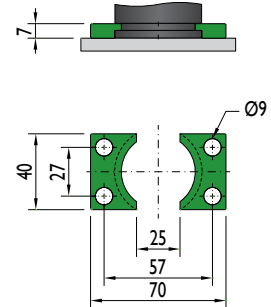

**XS-500**

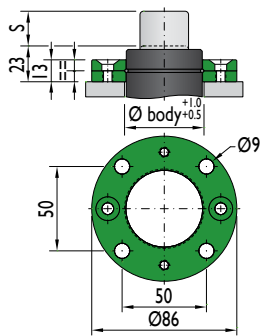

**XC-500**

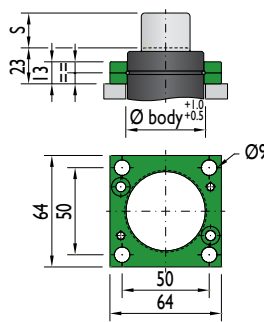

**PR-500**

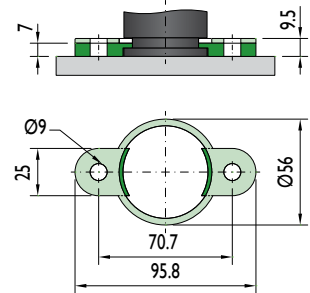

**CS-500**

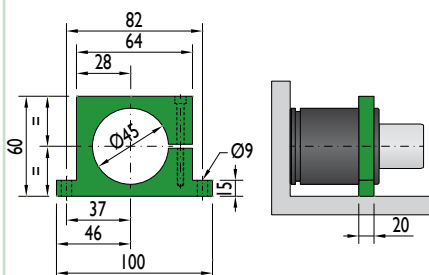

Flange must not support spring's force

**CF-500**

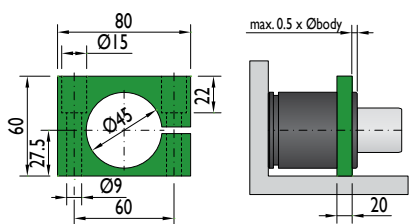

Flange must not support spring's force



SMS DNH  
3203N

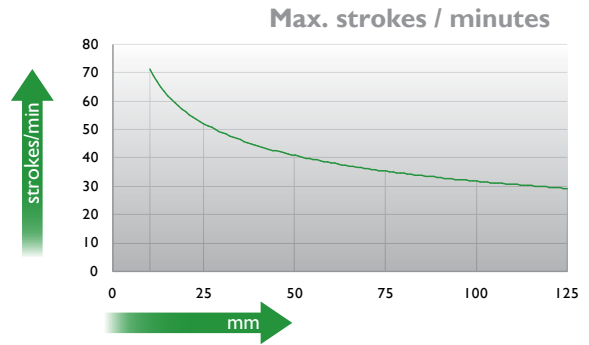
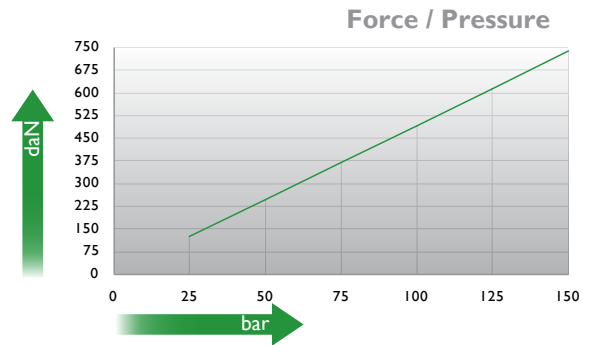
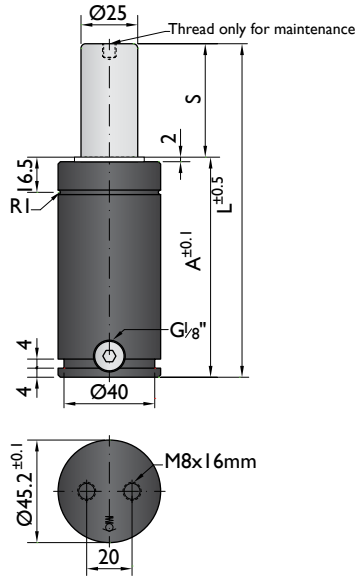

Ordering example: 4 x NR-750-125

Order No.	S <sup>(1)</sup> mm	L mm	A mm	F <sub>0</sub> <sup>(2)</sup> daN	F daN	(3)	kg
NR-750-10	10	67	57	740	1000	No	0.56
NR-750-13	13	73	60		1000	No	0.56
NR-750-16	16	79	63		1100	No	0.58
NR-750-19	19	85	66		1100	No	0.59
NR-750-25	25	97	72		1100	No	0.63
NR-750-32	32	111	79		1100	No	0.66
NR-750-38	38	123	85		1100	No	0.71
NR-750-50	50	147	97		1100	Yes	0.78
NR-750-63	63	173	110		1100	Yes	0.85
NR-750-75	75	197	122		1100	Yes	0.94
NR-750-80	80	207	127		1100	Yes	0.98
NR-750-100	100	247	147		1100	Yes	1.10
NR-750-125	125	297	172		1100	Yes	1.25

<sup>(1)</sup> other strokes under request

<sup>(2)</sup> alternative forces upon request

<sup>(3)</sup> ESK available for other strokes



Pressure medium N<sub>2</sub>  
Max. Charging pressure 150 bar  
Min. Charging pressure 25 bar

Working temperature 0-80°C  
Temperature related force increase +0.34%/°C  
Max. working speed 1.6 m/s

Min. security stroke 10%  
Repair Kit KIT NR-750  
Linkable M6

### Mounting possibilities

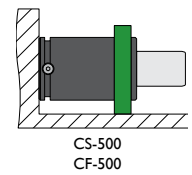
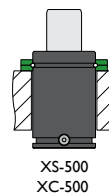
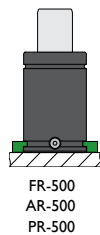
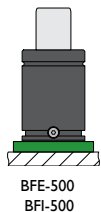
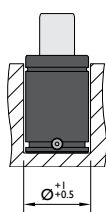
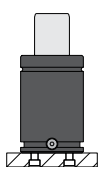

Flange must not support spring's force

## Flanges

**BFE-500**

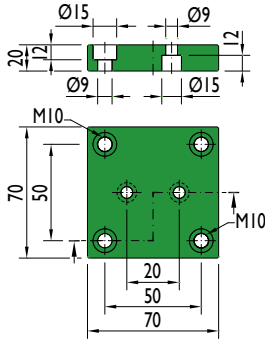

**BFI-500**

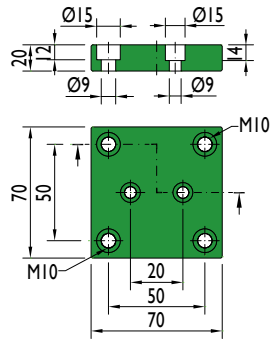

**FR-500**

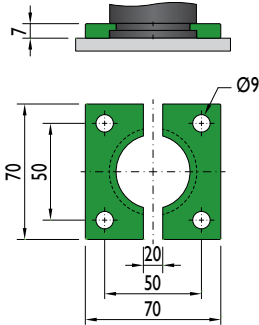

**AR-500**

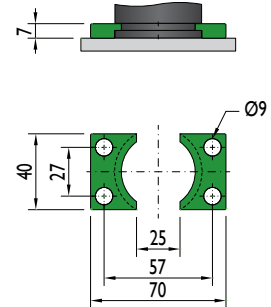

**XS-500**

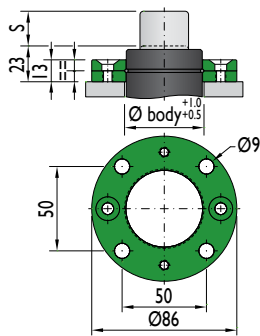

**XC-500**

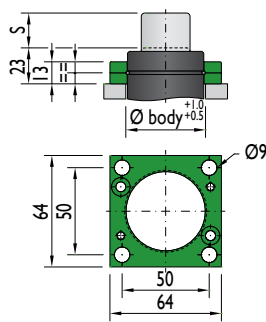

**PR-500**

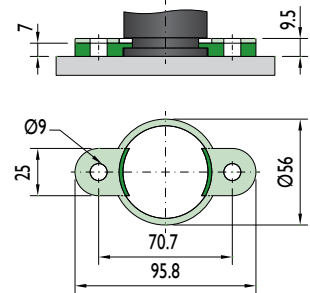

**CS-500**

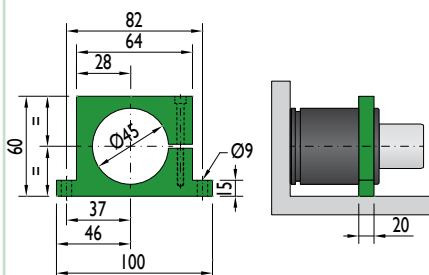

Flange must not support spring's force

**CF-500**

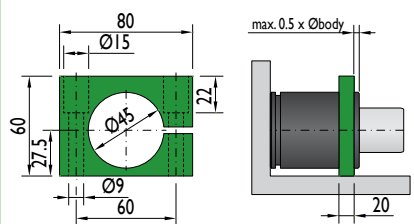

Flange must not support spring's force



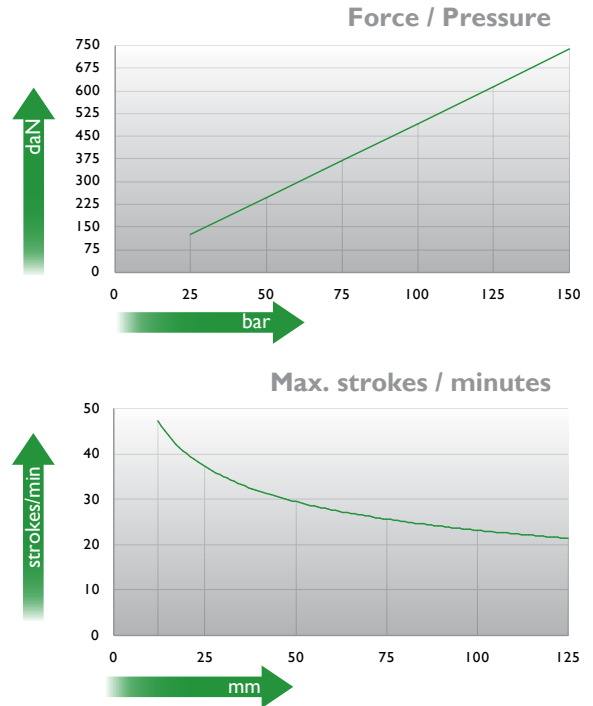
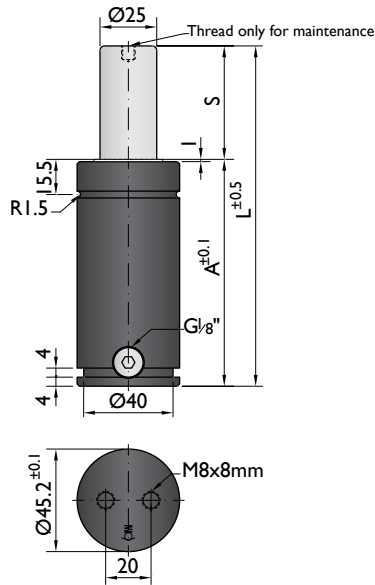

Ordering example: 4 x K-750-125

Order No.	S <sup>(1)</sup> mm	L mm	A mm	F <sub>0</sub> <sup>(2)</sup> daN (20°C, 150 bar)	F daN	 <sup>(3)</sup>	kg
K-750-12	12	74	62		1000	No	0.59
K-750-19	19	88	69		1100	No	0.69
K-750-25	25	100	75		1100	No	0.72
K-750-38	38	126	88		1200	No	0.80
K-750-50	50	150	100	740	1200	Yes	0.88
K-750-63	63	176	113		1200	Yes	0.90
K-750-80	80	210	130		1200	Yes	1.08
K-750-100	100	250	150		1200	Yes	1.23
K-750-125	125	300	175		1200	Yes	1.45

other strokes under request <sup>(1)</sup>

alternative forces upon request <sup>(2)</sup>

ESK available for other strokes <sup>(3)</sup>



Pressure medium	N <sub>2</sub>	Working temperature	0-80°C	Min. security stroke	10%
Max. Charging pressure	150 bar	Temperature related force increase	+0.34%/°C	Repair Kit	KIT K-750
Min. Charging pressure	25 bar	Max. working speed	1.6 m/s	Linkable	G1/8"

### Mounting possibilities

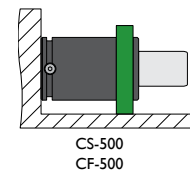
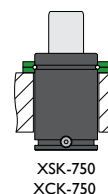
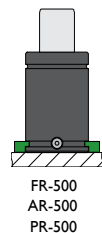
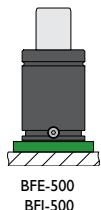
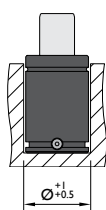
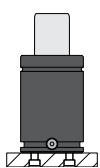

Flange must not support spring's force

## Flanges

**BFE-500**

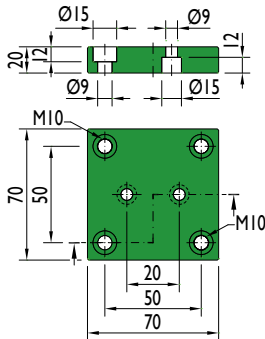

**BFI-500**

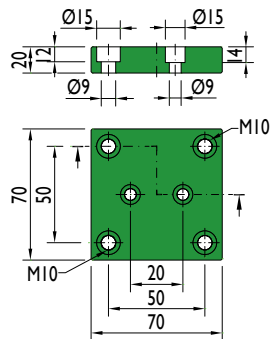

**FR-500**

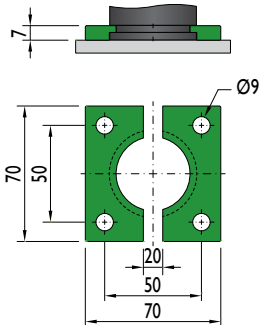

**AR-500**

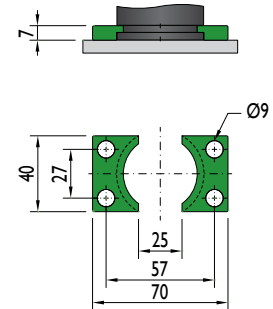

**XSK-750**

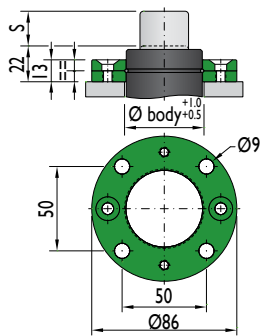

**XCK-750**

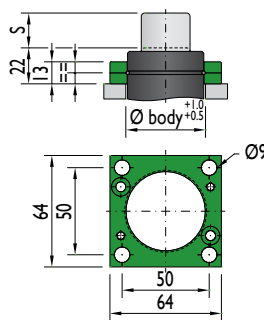

**PR-500**

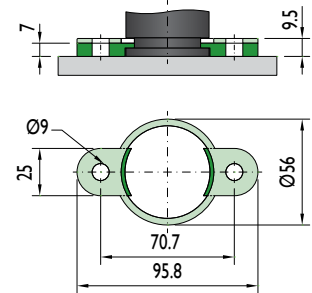

**CS-500**

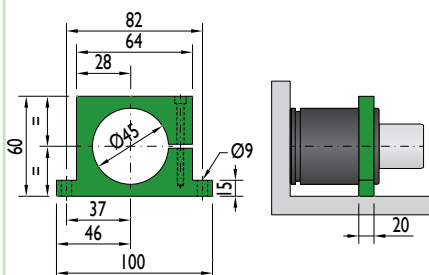

Flange must not support spring's force

**CF-500**

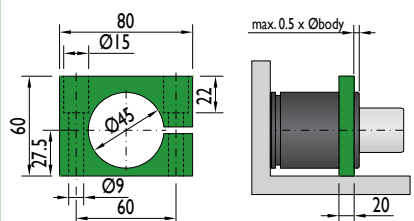

Flange must not support spring's force





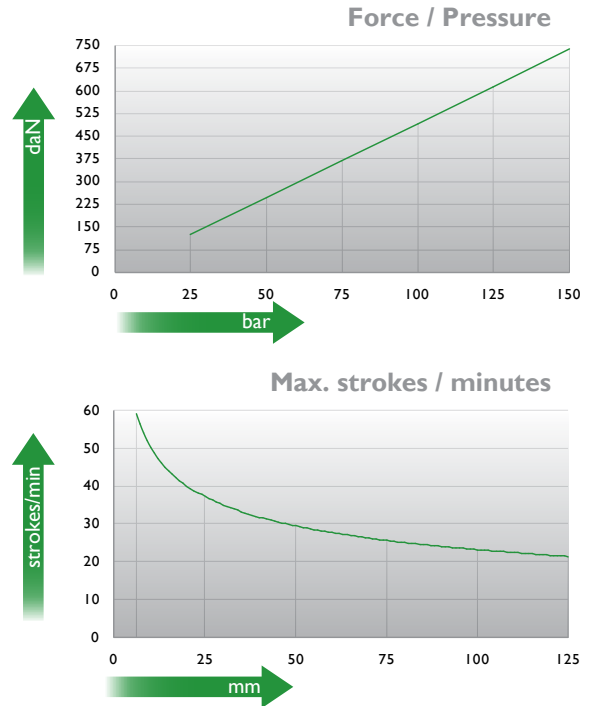
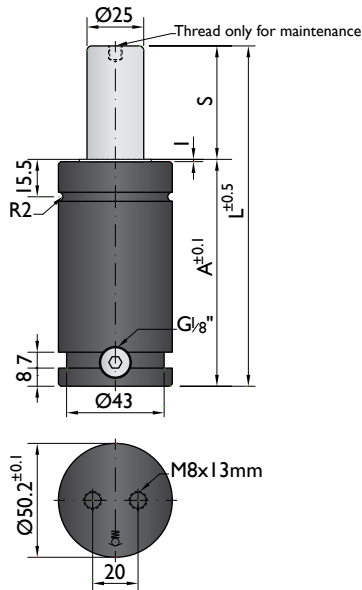

Ordering example: 4 x KH-750-125

Order No.	S <sup>(1)</sup> mm	L mm	A mm	F <sub>0</sub> <sup>(2)</sup> daN	F daN	(3)	kg
<b>KH-750-13</b>	12.7	75.4	62.7		1300	No	0.73
<b>KH-750-19</b>	19	88	69		1300	No	0.80
<b>KH-750-25</b>	25	100	75		1200	No	0.84
<b>KH-750-38</b>	38.1	126.2	88.1		1100	No	0.95
<b>KH-750-50</b>	50	150	100	740	1100	Yes	1.06
<b>KH-750-63</b>	63.5	177	113.5		1100	Yes	1.14
<b>KH-750-80</b>	80	210	130		1100	Yes	1.32
<b>KH-750-100</b>	100	250	150		1100	Yes	1.50
<b>KH-750-125</b>	125	300	175		1100	Yes	1.62

other strokes under request

alternative forces upon request

ESK available for other strokes



Pressure medium	N <sub>2</sub>	Working temperature	0-80°C	Min. security stroke	10%
Max. Charging pressure	150 bar	Temperature related force increase	+0.34%/°C	Repair Kit	KIT KH-750
Min. Charging pressure	25 bar	Max. working speed	1.6 m/s	Linkable	G1/8"

### Mounting possibilities

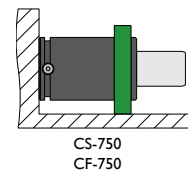
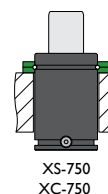
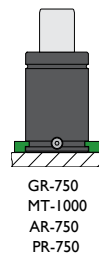
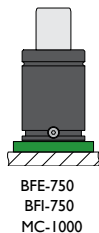
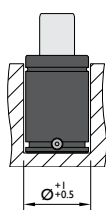
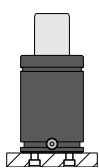

Flange must not support spring's force

## Flanges

### BFE-750

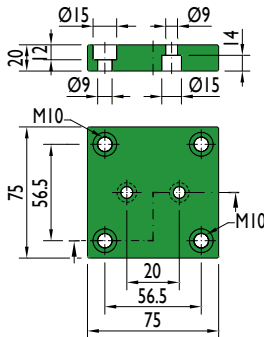

### BFI-750

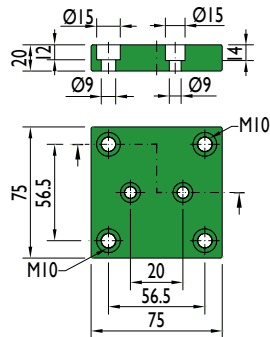

### MC-1000

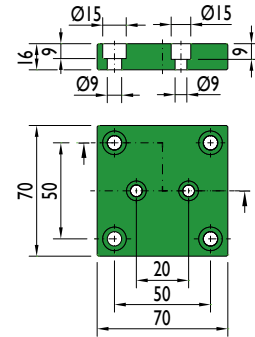

### GR-750

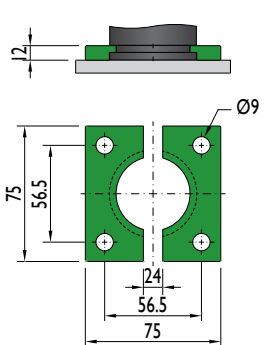

### MT-1000

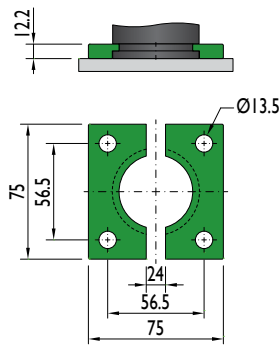

### AR-750

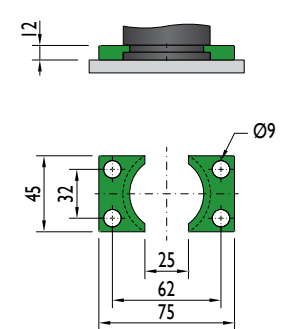

### XS-750

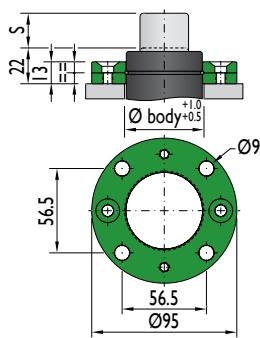

### XC-750

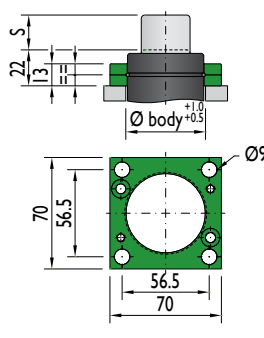

### PR-750

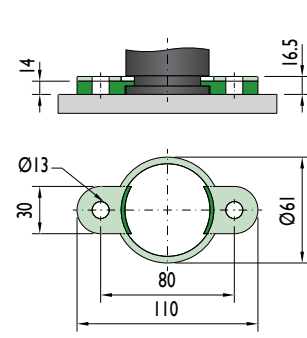

### CS-750

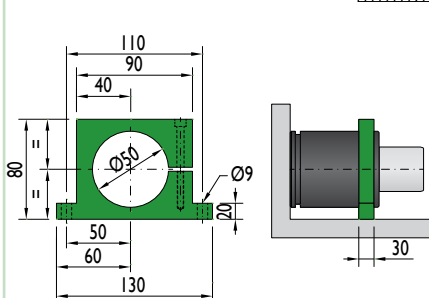

Flange must not support spring's force



### CF-750

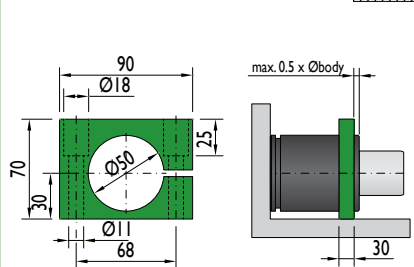

Flange must not support spring's force



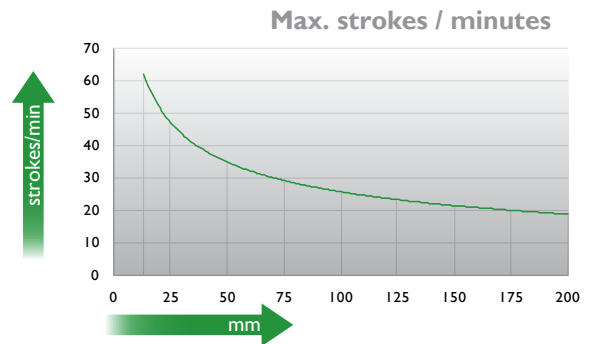
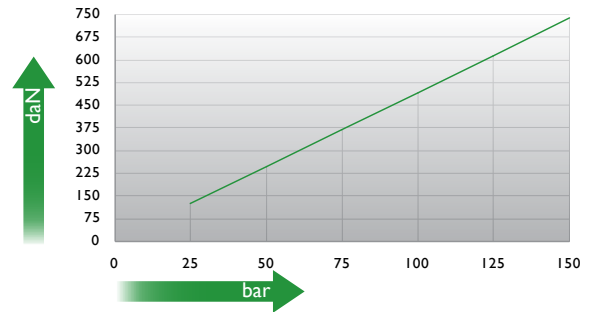
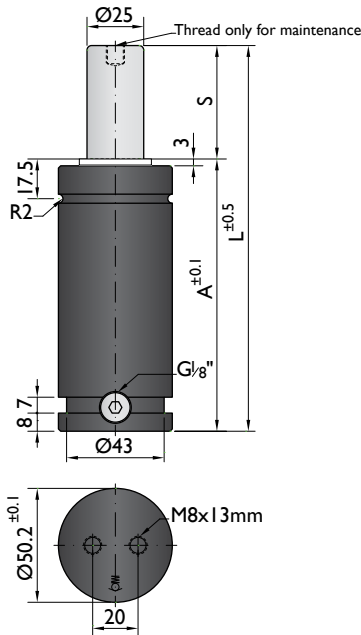

Ordering example: 4 x HG-750-125

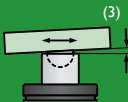
Order No.	S <sup>(1)</sup> mm	L mm	A mm	F <sub>0</sub> <sup>(2)</sup> daN (20°C, 150 bar)	F daN	 <sup>(3)</sup>	kg
HG-750-13	12.5	95	82.5	740	1100	No	0.97
HG-750-25	25	120	95		1100	No	1.08
HG-750-38	37.5	145	107.5		1100	No	1.2
HG-750-50	50	170	120		1100	No	1.32
HG-750-63	62.5	195	132.5		1100	No	1.42
HG-750-80	80	230	150		1100	Yes	1.58
HG-750-100	100	270	170		1100	Yes	1.77
HG-750-125	125	320	195		1200	Yes	2.01
HG-750-160	160	390	230		1200	Yes	2.34
HG-750-200	200	470	270		1200	Yes	2.72

<sup>(1)</sup> other strokes under request

<sup>(2)</sup> alternative forces upon request

<sup>(3)</sup> ESK available for other strokes



Pressure medium	N <sub>2</sub>	Working temperature	0-80°C	Min. security stroke	10%
Max. Charging pressure	150 bar	Temperature related force increase	+0.34%/°C	Repair Kit	KIT HG-750
Min. Charging pressure	25 bar	Max. working speed	1.6 m/s	Linkable	G1/8"

### Mounting possibilities

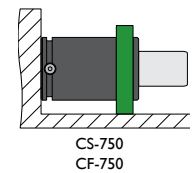
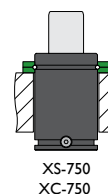
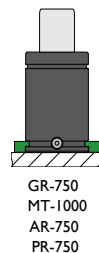
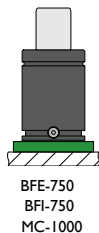
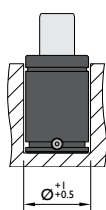
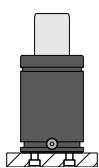

Flange must not support spring's force

## Flanges

### BFE-750

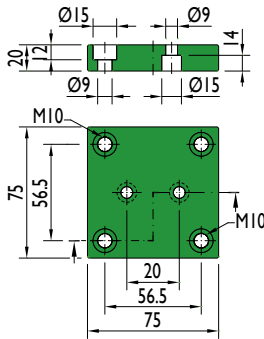

### BFI-750

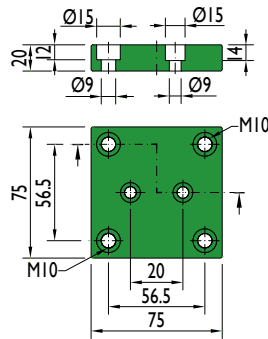

### MC-1000

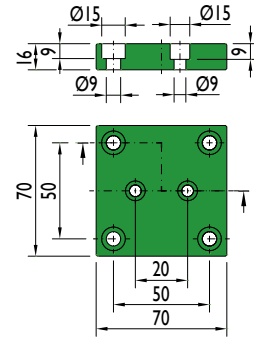

### GR-750

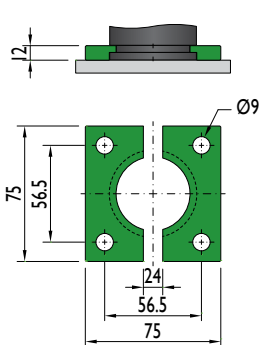

### MT-1000

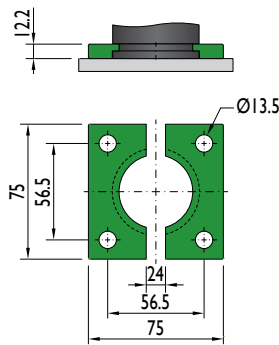

### AR-750

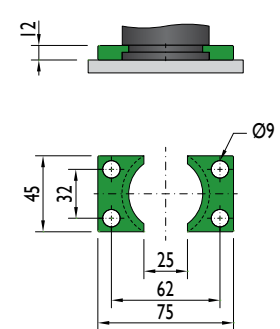

### XS-750

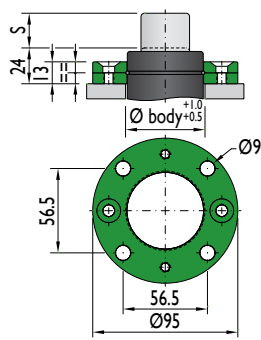

### XC-750

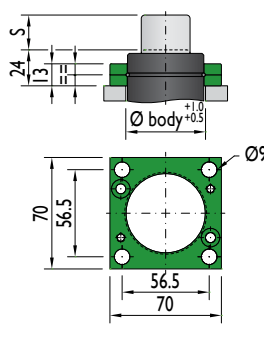

### PR-750

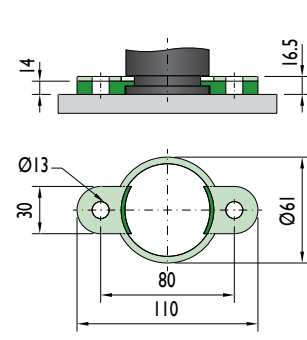

### CS-750

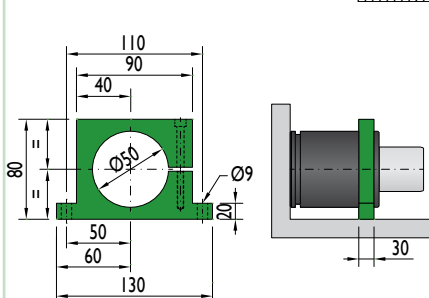

Flange must not support spring's force



### CF-750

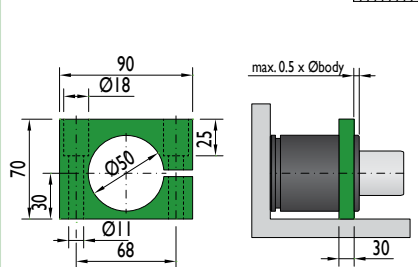

Flange must not support spring's force



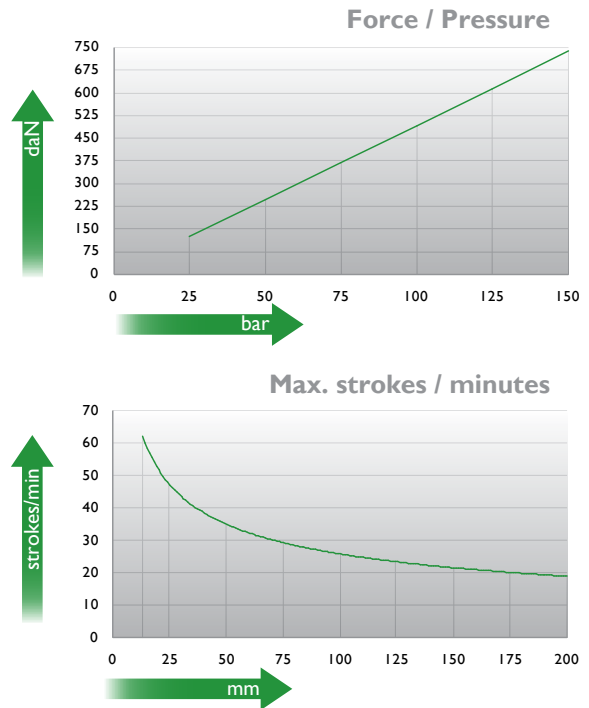
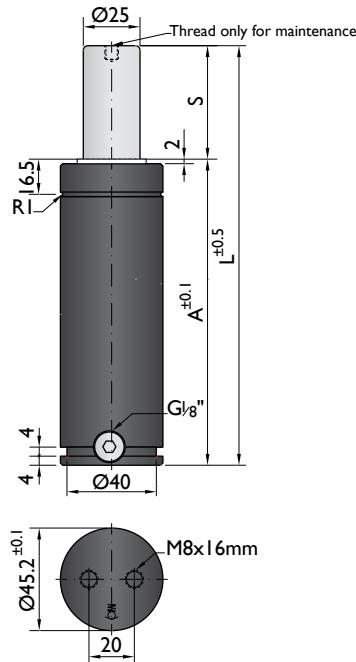

Ordering example: 4 x HD-750-125

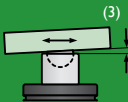
Order No.	S <sup>(1)</sup> mm	L mm	A mm	F <sub>0</sub> <sup>(2)</sup> daN (20°C, 150 bar)	F daN	 <sup>(3)</sup>	kg
HD-750-13	13	111	98	740	1100	No	0.80
HD-750-25	25	135	110		1100	No	0.93
HD-750-38	38	161	123		1100	No	1.10
HD-750-50	50	185	135		1200	No	1.17
HD-750-63	63	211	148		1200	No	1.30
HD-750-80	80	245	165		1200	Yes	1.45
HD-750-100	100	285	185		1200	Yes	1.65
HD-750-125	125	335	210		1200	Yes	1.80
HD-750-160	160	405	245		1300	Yes	1.84
HD-750-200	200	485	285		1300	Yes	2.23

<sup>(1)</sup> other strokes under request

<sup>(2)</sup> alternative forces upon request

<sup>(3)</sup> ESK available for other strokes



Pressure medium	N <sub>2</sub>	Working temperature	0-80°C	Min. security stroke	10%
Max. Charging pressure	150 bar	Temperature related force increase	+0.34%/°C	Repair Kit	KIT HD-750
Min. Charging pressure	25 bar	Max. working speed	1.6 m/s	Linkable	G1/8"

### Mounting possibilities

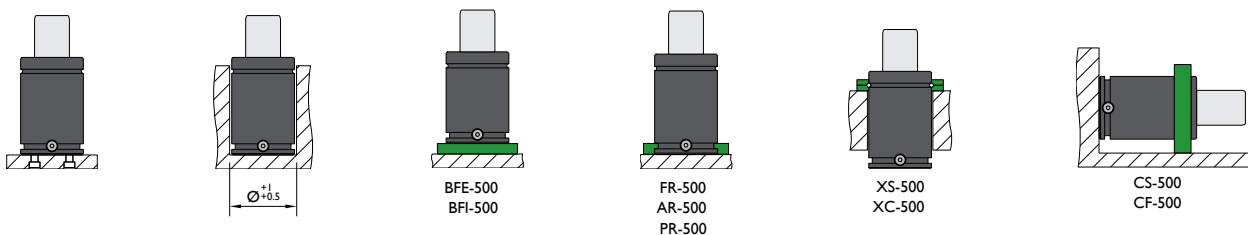

Flange must not support spring's force

## Flanges

**BFE-500**

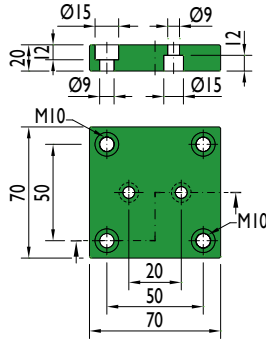

**BFI-500**

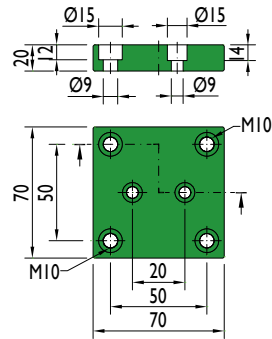

**FR-500**

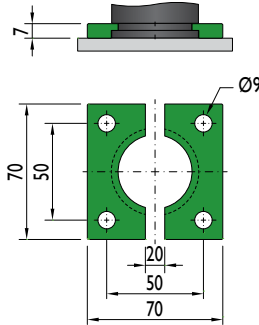

**AR-500**

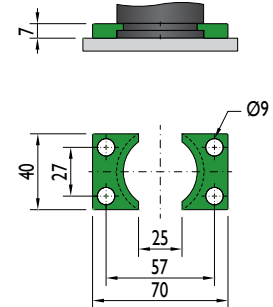

**XS-500**

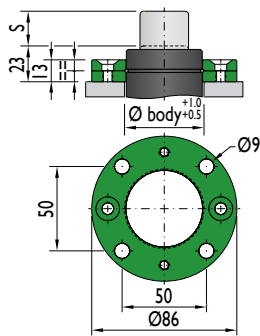

**XC-500**

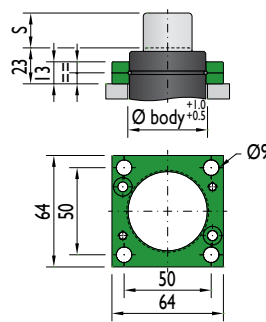

**PR-500**

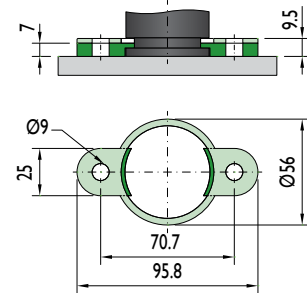

**CS-500**

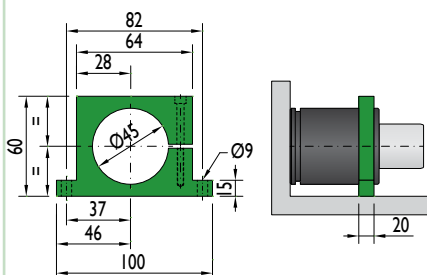

Flange must not support spring's force

**CF-500**

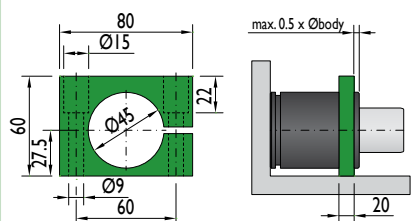

Flange must not support spring's force



CNOMO  
EM24.54.700

PSA  
E24.54.815.G

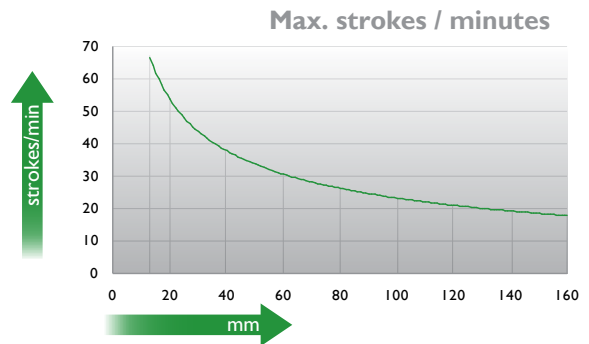
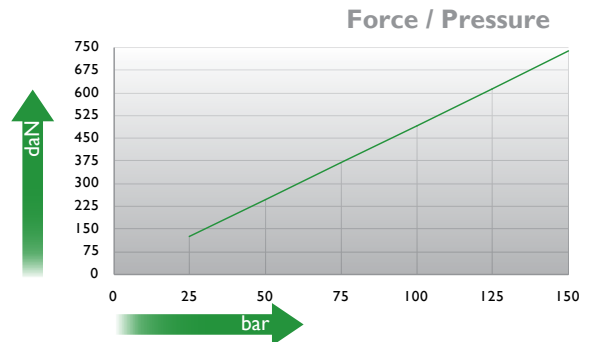
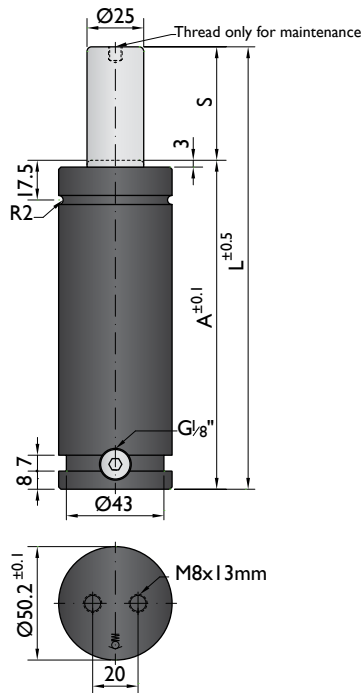

Ordering example: 4 x G-750-125

Order No.	S <sup>(1)</sup> mm	L mm	A mm	F <sub>0</sub> daN	F daN	(3)	kg
G-750-13	12.7	120.4	107.7	740	800	No	1.20
G-750-25	25	145	120		900	No	1.21
G-750-38	38.1	171.2	133.1		900	No	1.38
G-750-50	50	195	145		900	No	1.50
G-750-63	63.5	222	158.5		900	No	1.57
G-750-80	80	255	175		1000	No	1.63
G-750-100	100	295	195		1000	Yes	1.85
G-750-125	125	345	220		1000	Yes	2.01
G-750-160	160	415	255		1100	Yes	3.80
G-750-200	200	495	295		1100	Yes	3.90
G-750-250	250	595	345	1200	Yes	4.00	
G-750-300	300	695	395	1200	Yes	4.20	

(1) other strokes under request

(2) alternative forces upon request

(3) ESK available for other strokes



Pressure medium N<sub>2</sub>  
Max. Charging pressure 150 bar  
Min. Charging pressure 25 bar

Working temperature 0-80°C  
Temperature related force increase +0.34%/°C  
Max. working speed 1.6 m/s

Min. security stroke 10%  
Repair Kit KIT G-750  
Linkable G1/8"

## Mounting possibilities

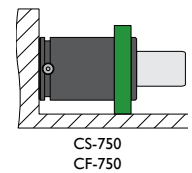
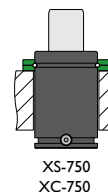
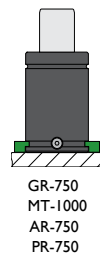
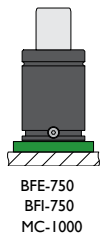
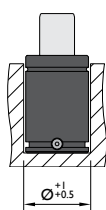
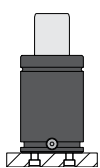

Flange must not support spring's force

## Flanges

### BFE-750

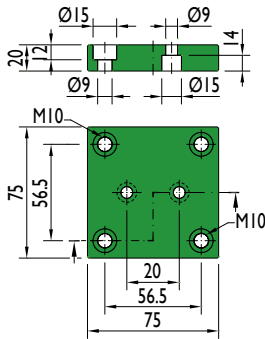

### BFI-750

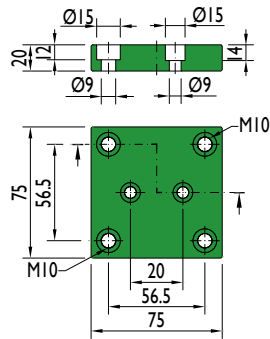

### MC-1000

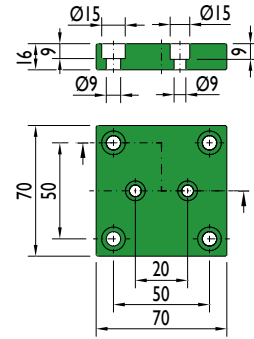

### GR-750

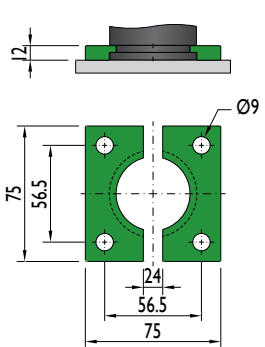

### MT-1000

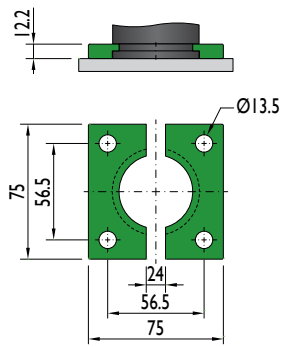

### AR-750

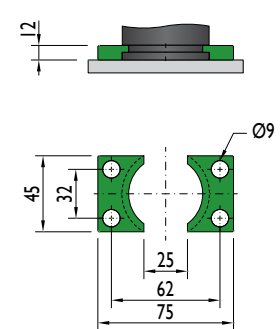

### XS-750

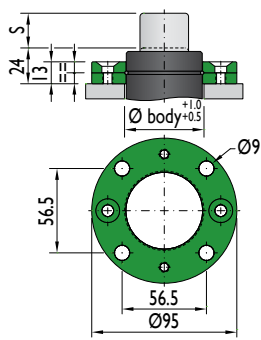

### XC-750

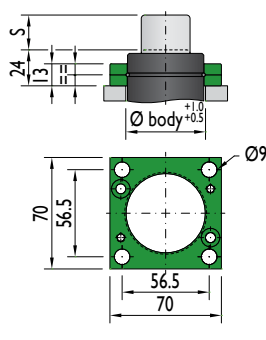

### PR-750

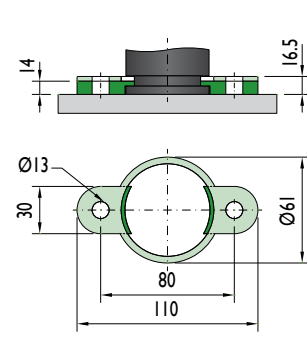

### CS-750

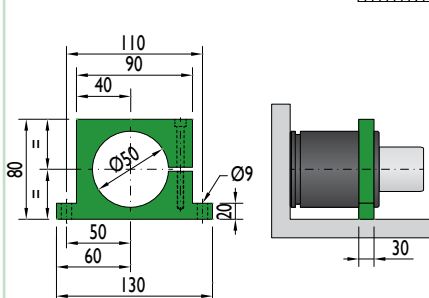

Flange must not support spring's force

### CF-750

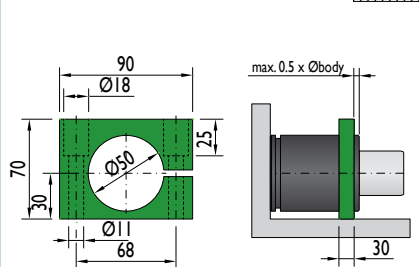

Flange must not support spring's force

Special mounts available on  
[www.nitrogas.com](http://www.nitrogas.com)



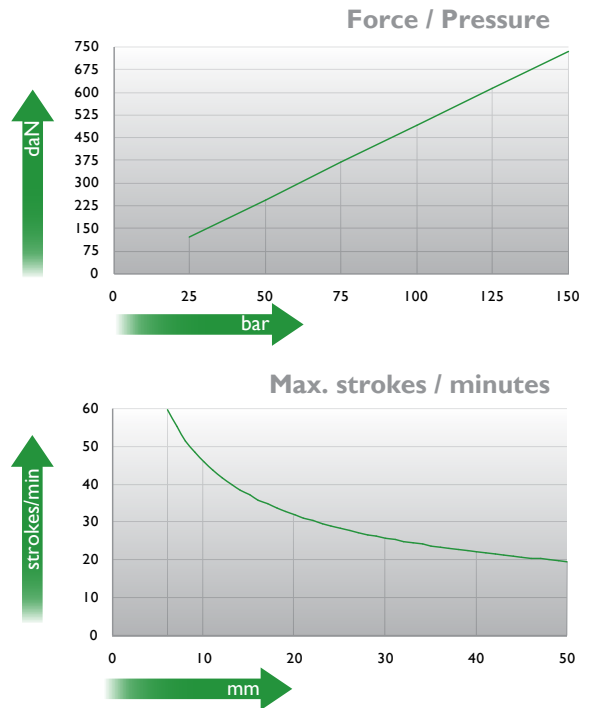
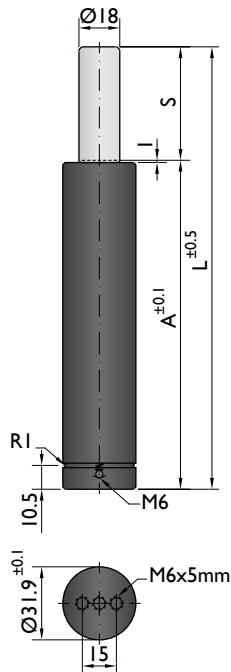

Ordering example: 4 x T-750-50

Order No.	S <sup>(1)</sup> mm	L mm	A mm	F <sub>0</sub> <sup>(2)</sup> daN	F daN		kg
T-750-6	6	63	57		1200	No	0.27
T-750-10	10	75	65		1200	No	0.32
T-750-16	16	93	77		1200	No	0.36
T-750-25	25	120	95	740	1300	No	0.47
T-750-32	32	140	108		1300	No	0.48
T-750-40	40	165	125		1300	No	0.55
T-750-50	50	195	145		1300	No	0.63

other strokes <sup>(1)</sup> under request

alternative forces <sup>(2)</sup> upon request



Pressure medium	N <sub>2</sub>	Working temperature	0-80°C	Min. security stroke	10%
Max. Charging pressure	150 bar	Temperature related force increase	+0.34%/°C	Repair Kit	Non-repairable
Min. Charging pressure	25 bar	Max. working speed	0.5 m/s	Linkable	No

### Mounting possibilities

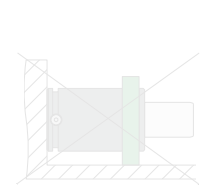
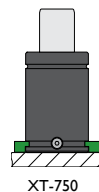
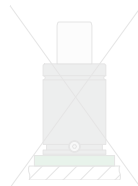
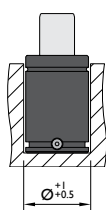
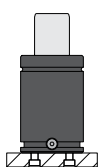

## Flanges

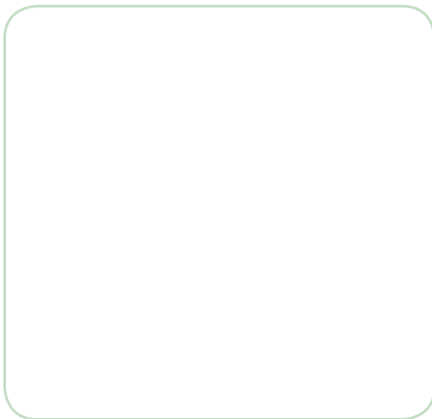
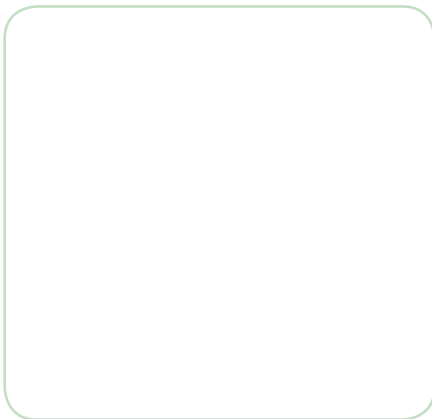
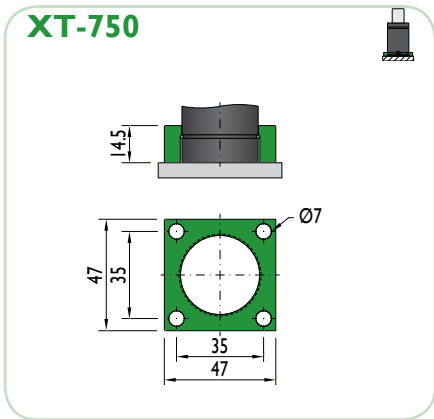

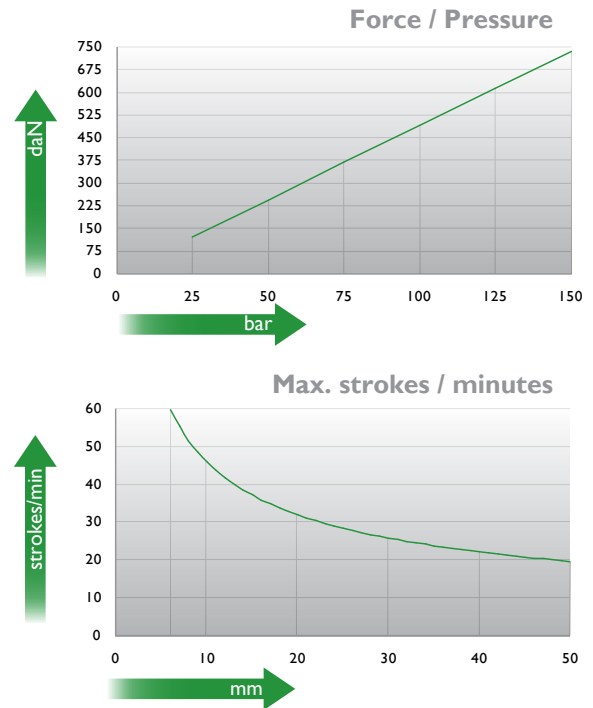
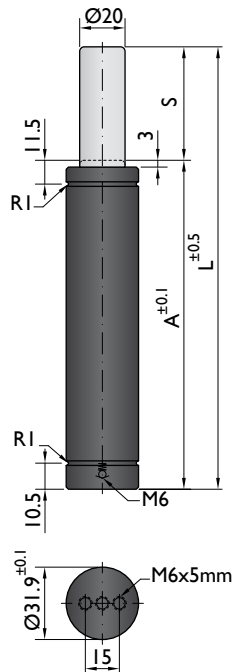

Ordering example: 4 x TS-750-50

Order No.	S <sup>(1)</sup> mm	L mm	A mm	F <sub>0</sub> <sup>(2)</sup> daN (20°C, 150 bar)	F daN		kg
TS-750-6	6	63	57	740	1200	No	0.27
TS-750-10	10	75	65		1200	No	0.32
TS-750-16	16	93	77		1200	No	0.36
TS-750-25	25	120	95		1300	No	0.47
TS-750-32	32	140	108		1300	No	0.48
TS-750-40	40	165	125		1300	No	0.55
TS-750-50	50	195	145	1300	No	0.63	

other strokes <sup>(1)</sup> under request

alternative forces <sup>(2)</sup> upon request



Pressure medium	N <sub>2</sub>	Working temperature	0-80°C	Min. security stroke	10%
Max. Charging pressure	150 bar	Temperature related force increase	+0.34%/°C	Repair Kit	Non-repairable
Min. Charging pressure	25 bar	Max. working speed	0.5 m/s	Linkable	No

### Mounting possibilities

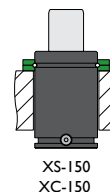
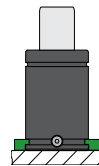
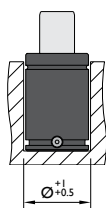
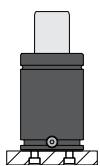

## Flanges



**XT-750**

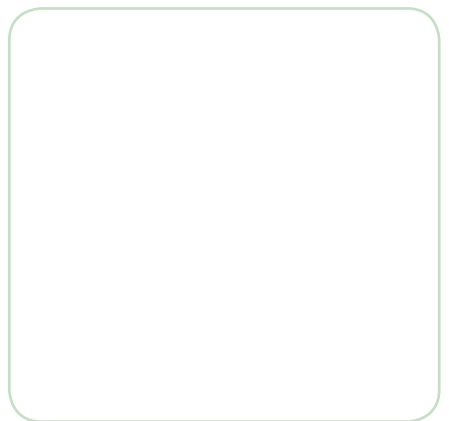
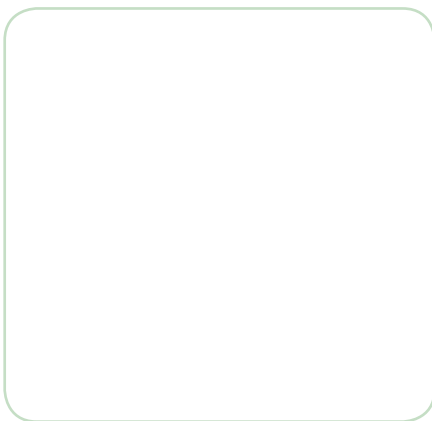

**XS-150**

ISO

**XC-150**

VDI



## Force 1000 daN

### Piston Rod Sealed gas springs

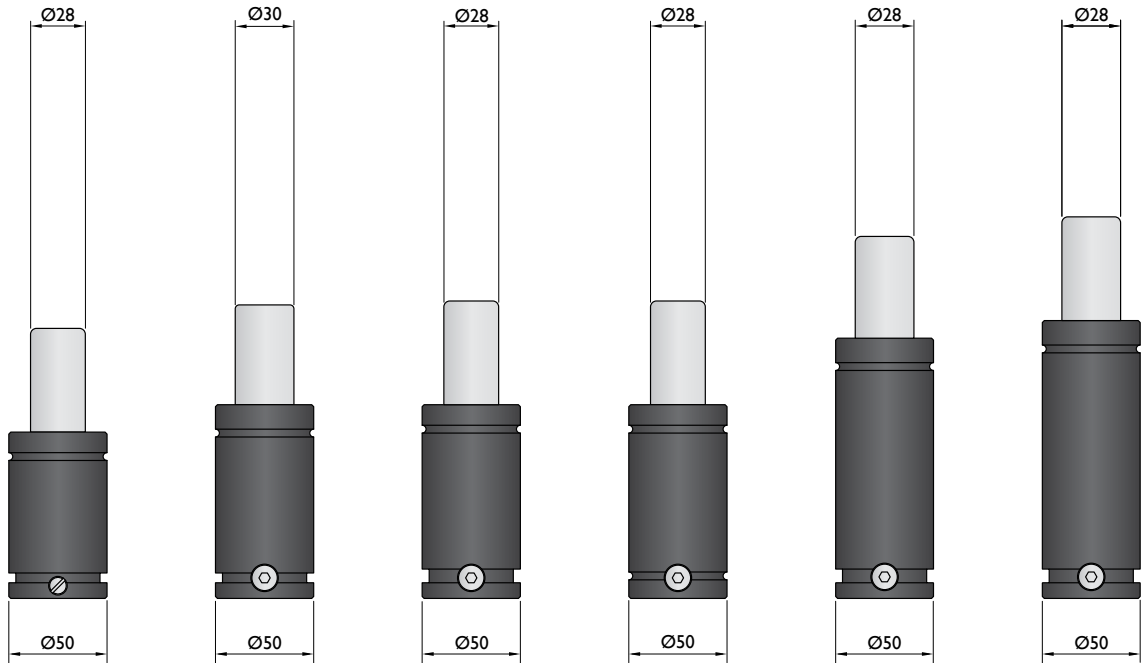
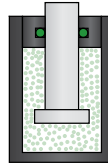

Model	KP-1000	K-1000	NR-1000	NT-1000	M-1000	HD-1000
Initial F (daN)	920	990	920	920	920	920
L max (mm)	2xStroke+38	2xStroke+50	2xStroke+52	2xStroke+52	2xStroke+85	2xStroke+95
Stroke (mm)	13-125	12-125	13-125	13-125	25-160	25-300

\* other strokes under request

### Standards

PED 97/23/EC	PED 97/23/EC	PED 97/23/EC	PED 97/23/EC	PED 97/23/EC	PED 97/23/EC
ISO 11901	ISO 11901	ISO 11901	ISO 11901	ISO 11901	ISO 11901
VDI 3003	VDI 3003	VDI 3003	VDI 3003	VDI 3003	VDI 3003
CNOMO EM24.54.700	CNOMO EM24.54.700	CNOMO EM24.54.700	CNOMO EM24.54.700	CNOMO EM24.54.700	CNOMO EM24.54.700

## Force 1000 daN

### Bore Sealed gas springs

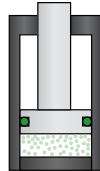

Model	T-1000	TC-1000	TS-1000	TSC-1000
Initial F (daN)	920	920	920	920
L max (mm)	61-230	81-250	61-230	81-250
Stroke (mm)	6-50	6-50	6-50	6-50

\* other strokes under request

### Standards

**PED**  
97/23/EC

ISO  
11901

VDI  
3003

**CNOMO**  
EM24.54.700

**PED**  
97/23/EC

ISO  
11901

VDI  
3003

**CNOMO**  
EM24.54.700

**PED**  
97/23/EC

ISO  
11901

VDI  
3003

**CNOMO**  
EM24.54.700

**PED**  
97/23/EC

ISO  
11901

VDI  
3003

**CNOMO**  
EM24.54.700

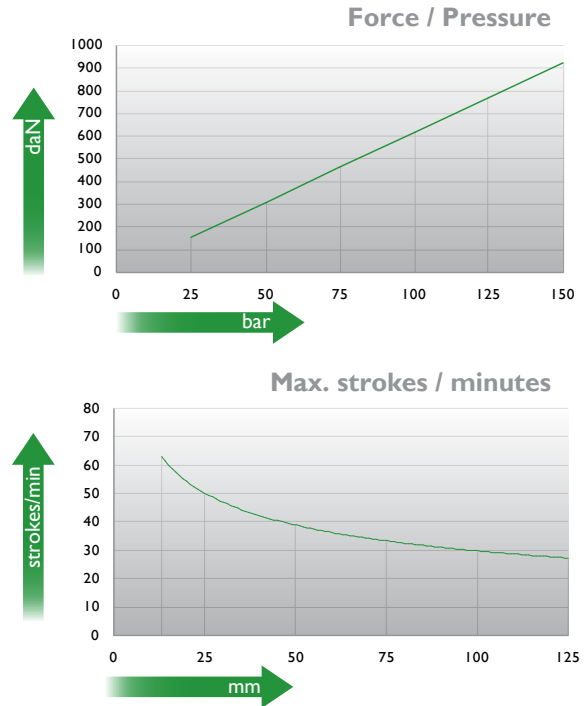
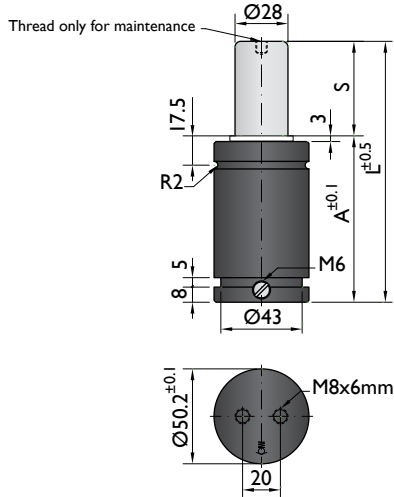

Ordering example: 4 x KP-1000-125

Order No.	S <sup>(1)</sup> mm	L mm	A mm	F <sub>0</sub> <sup>(2)</sup> daN	F daN	 <sup>(3)</sup>	kg
KP-1000-13	13	64	51	920	1400	No	0.57
KP-1000-16	16	70	54		1400	No	0.59
KP-1000-19	19	76	57		1400	No	0.62
KP-1000-25	25	88	63		1400	No	0.67
KP-1000-32	32	102	70		1400	No	0.73
KP-1000-38	38	114	76		1400	No	0.78
KP-1000-50	50	138	88		1400	Yes	0.88
KP-1000-63	63	164	101		1400	Yes	0.99
KP-1000-75	75	188	113		1400	Yes	1.09
KP-1000-80	80	198	118		1400	Yes	1.13
KP-1000-100	100	238	138		1400	Yes	1.30
KP-1000-125	125	288	163		1400	Yes	1.51

<sup>(1)</sup> other strokes under request

<sup>(2)</sup> alternative forces upon request

<sup>(3)</sup> ESK available for other strokes



Pressure medium	N <sub>2</sub>	Working temperature	0-80°C	Min. security stroke	10%
Max. Charging pressure	150 bar	Temperature related force increase	+0.34%/°C	Repair Kit	KIT KP-1000
Min. Charging pressure	25 bar	Max. working speed	1.6 m/s	Linkable	M6

## Mounting possibilities

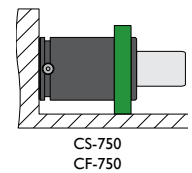
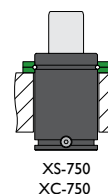
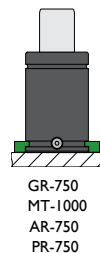
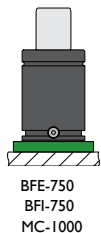
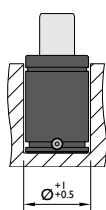
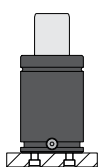

Flange must not support spring's force

## Flanges

### BFE-750

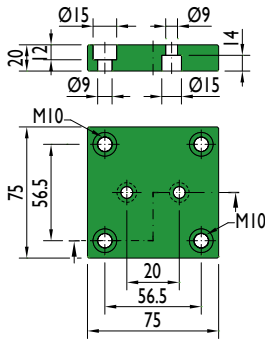

### BFI-750

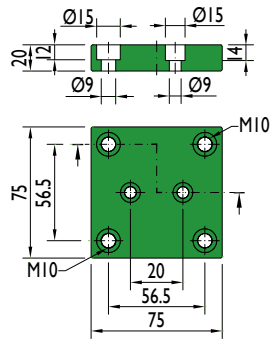

### MC-1000

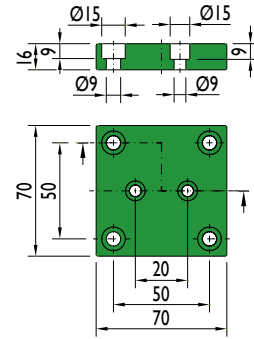

### GR-750

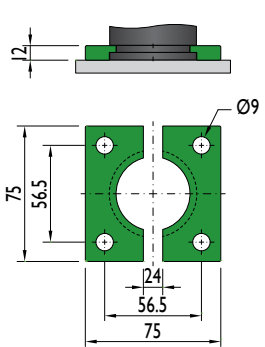

### MT-1000

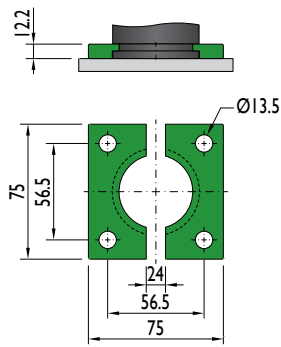

### AR-750

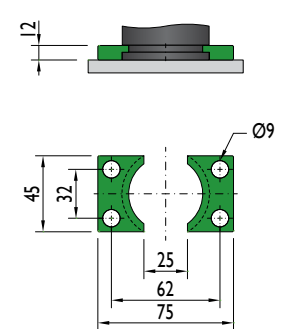

### XS-750

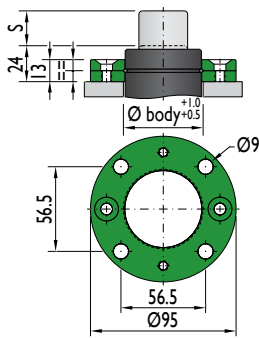

### XC-750

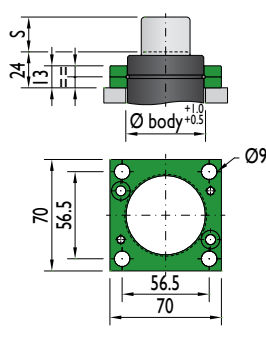

### PR-750

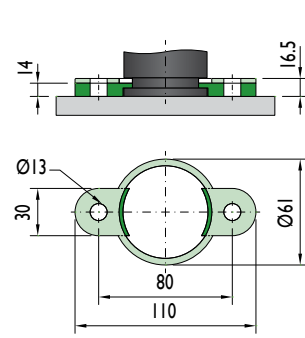

### CS-750

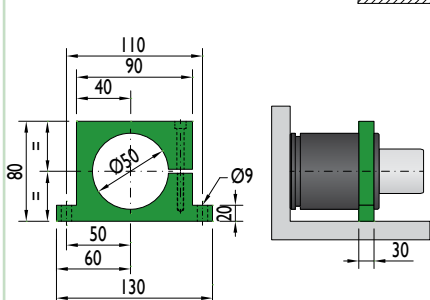

Flange must not support spring's force

### CF-750

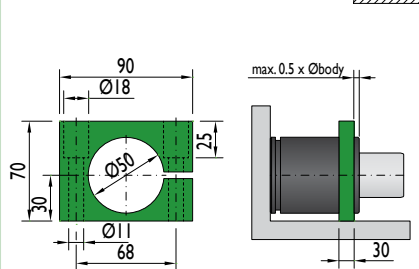

Flange must not support spring's force



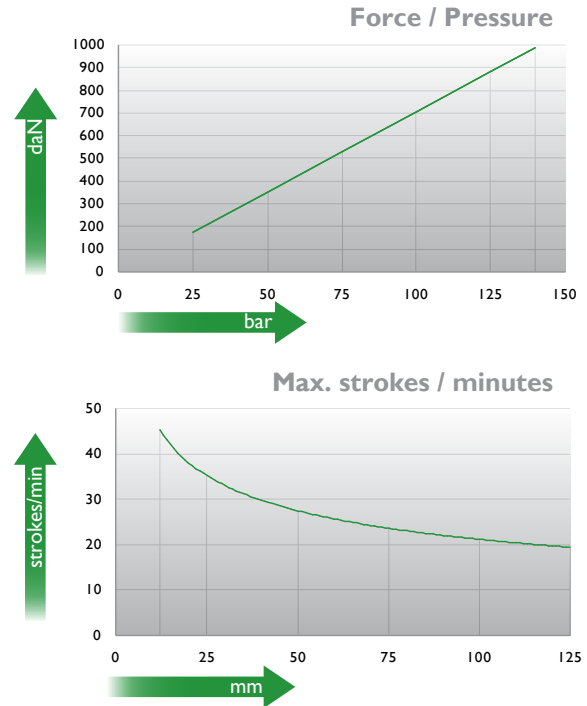
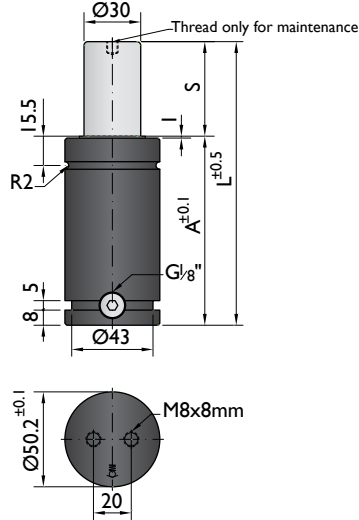

Ordering example: 4 x K-1000-125

Order No.	S <sup>(1)</sup> mm	L mm	A mm	F <sub>0</sub> <sup>(2)</sup> daN (20°C, 140 bar)	F daN		kg
K-1000-12	12	74	62		1500	No	0.69
K-1000-19	19	88	69		1500	No	0.78
K-1000-25	25	100	75		1600	No	0.84
K-1000-38	38	126	88		1600	No	0.96
K-1000-50	50	150	100	990	1600	Yes	1.06
K-1000-63	63	176	113		1700	Yes	1.18
K-1000-80	80	210	130		1700	Yes	1.35
K-1000-100	100	250	150		1700	Yes	1.40
K-1000-125	125	300	175		1700	Yes	1.49

other strokes <sup>(1)</sup> under request

alternative forces upon request <sup>(2)</sup>

ESK available for other strokes <sup>(3)</sup>



Pressure medium	N <sub>2</sub>	Working temperature	0-80°C	Min. security stroke	10%
Max. Charging pressure	140 bar	Temperature related force increase	+0.34%/°C	Repair Kit	KIT K-1000
Min. Charging pressure	25 bar	Max. working speed	1.6 m/s	Linkable	G1/8"

### Mounting possibilities

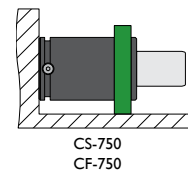
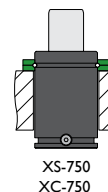
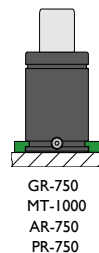
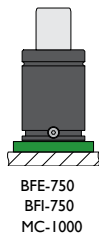
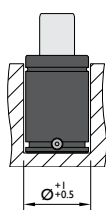
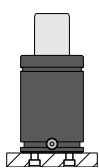

Flange must not support spring's force

## Flanges

### BFE-750

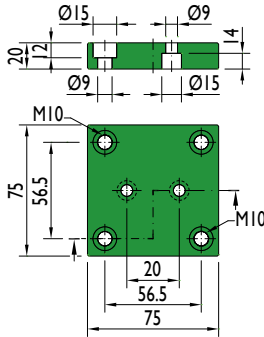

### BFI-750

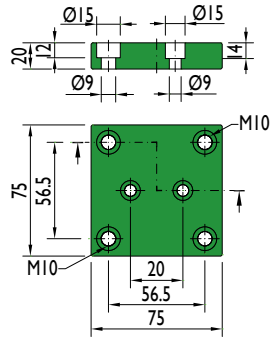

### MC-1000

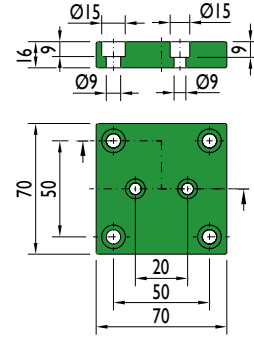

### GR-750

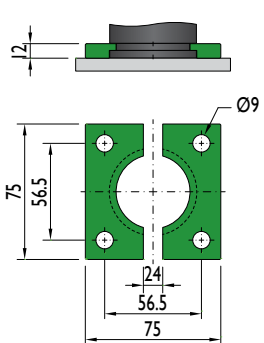

### MT-1000

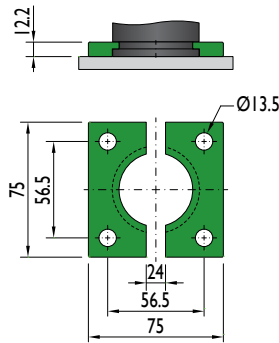

### AR-750

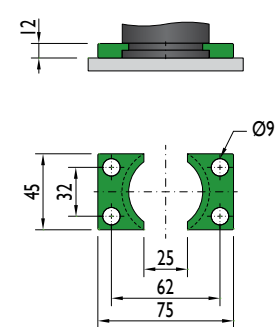

### XS-750

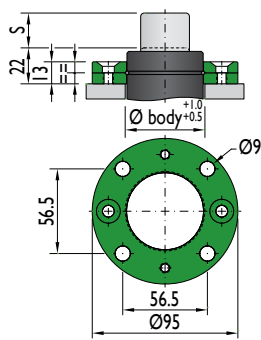

### XC-750

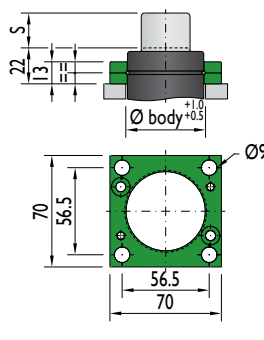

### PR-750

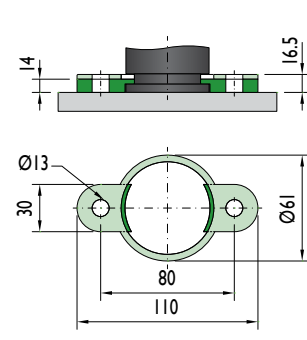

### CS-750

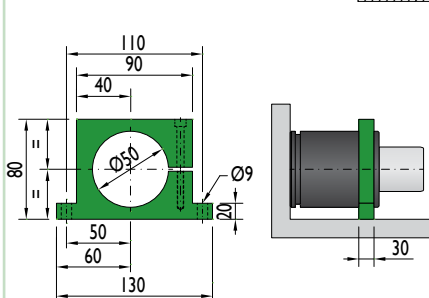

Flange must not support spring's force

### CF-750

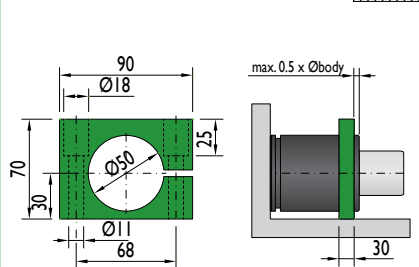

Flange must not support spring's force



\*The new cylinder will be supplied when the stock runs out.

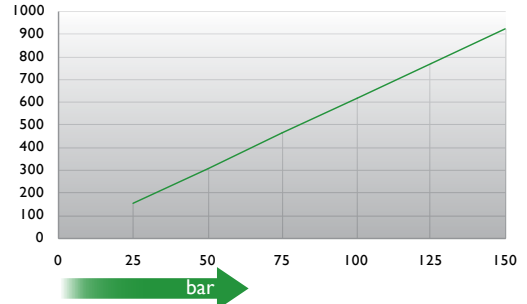
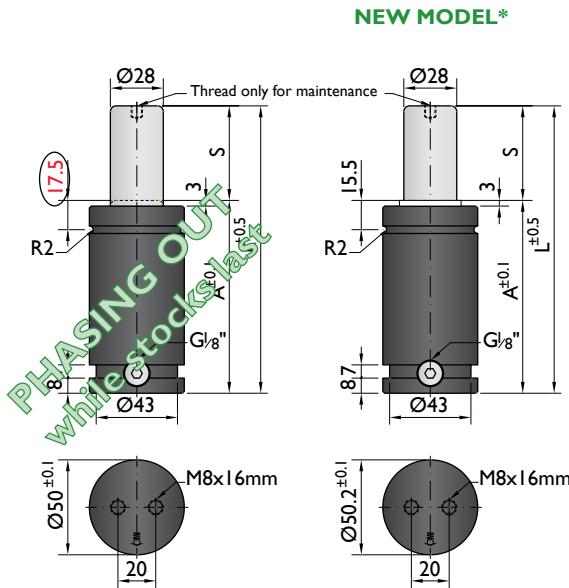

↑ daN

→ bar

↑ strokes/min

→ mm

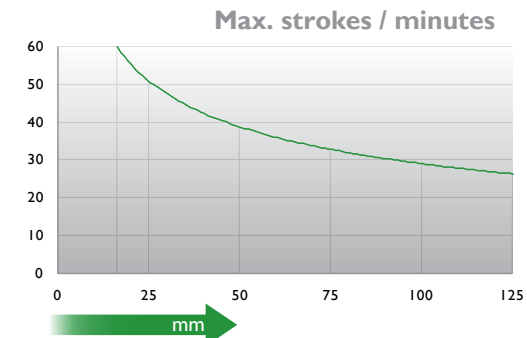

Ordering example: 4 x NR-1000-125

Order No.	S <sup>(1)</sup> mm	L mm	A mm	F <sub>0</sub> <sup>(2)</sup> daN (20°C, 150 bar)	F daN	 <sup>(3)</sup>	kg
NR-1000-13	13	78	65	920	1300	No	0.70
NR-1000-16	16	84	68		1300	No	0.76
NR-1000-19	19	90	71		1300	No	0.80
NR-1000-25	25	102	77		1300	No	0.84
NR-1000-32	32	116	84		1300	No	0.90
NR-1000-38	38	128	90		1400	No	0.96
NR-1000-50	50	152	102		1400	Yes	1.06
NR-1000-63	63	178	115		1400	Yes	1.18
NR-1000-75	75	202	127		1400	Yes	1.28
NR-1000-80	80	212	132		1400	Yes	1.35
NR-1000-100	100	252	152	1400	Yes	1.40	
NR-1000-125	125	302	177	1400	Yes	1.49	

<sup>(1)</sup> other strokes under request

<sup>(2)</sup> alternative forces upon request

<sup>(3)</sup> ESK available for other strokes



Pressure medium	N <sub>2</sub>	Working temperature	0-80°C	Min. security stroke	10%
Max. Charging pressure	150 bar	Temperature related force increase	+0.34%/°C	Repair Kit	KIT NR-1000
Min. Charging pressure	25 bar	Max. working speed	1.6 m/s	Linkable	G1/8"

### Mounting possibilities

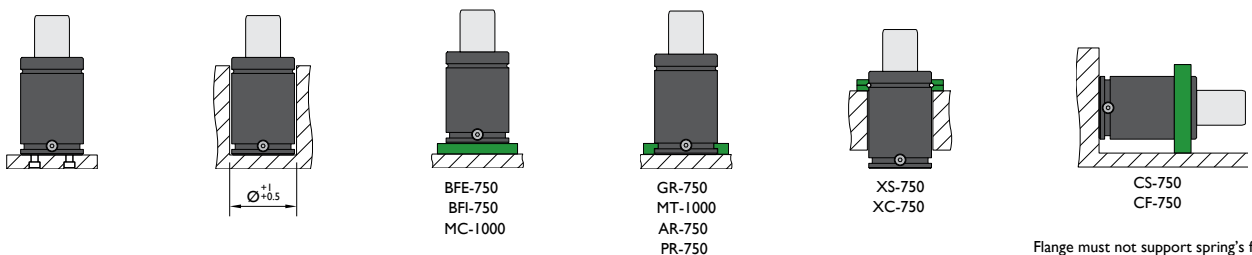

## Flanges

### BFE-750

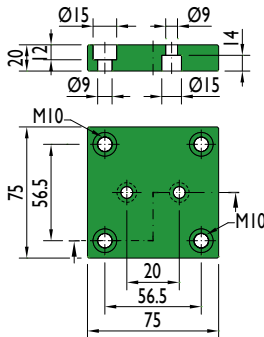

### BFI-750

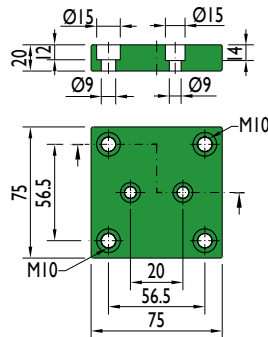

### MC-1000

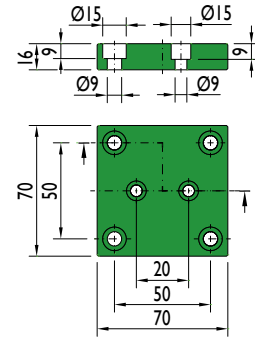

### GR-750

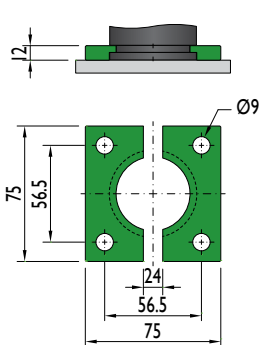

### MT-1000

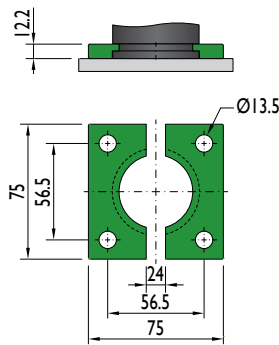

### AR-750

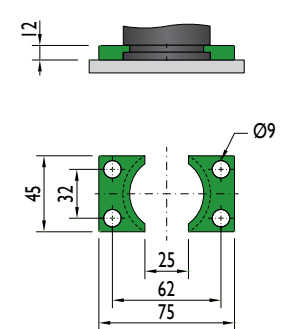

### XS-750

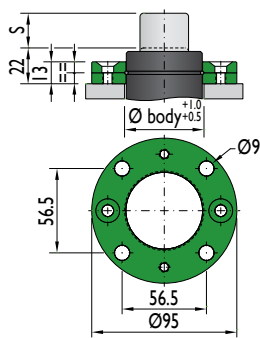

### XC-750

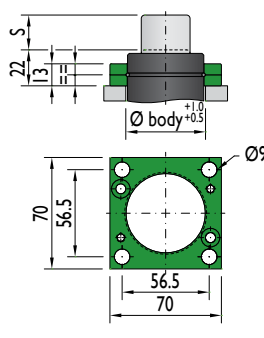

### PR-750

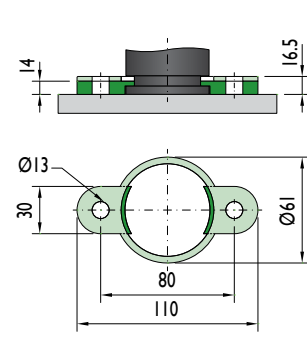

### CS-750

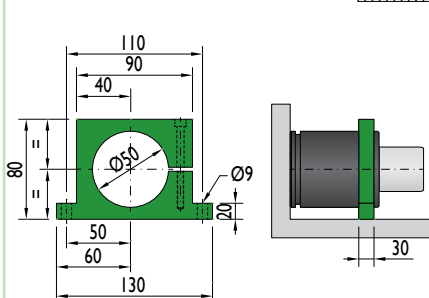

Flange must not support spring's force

### CF-750

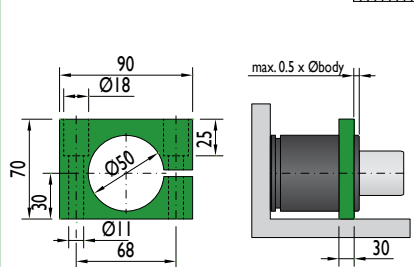

Flange must not support spring's force



PSA  
E24.54.815.G

SMS DNH  
3203N

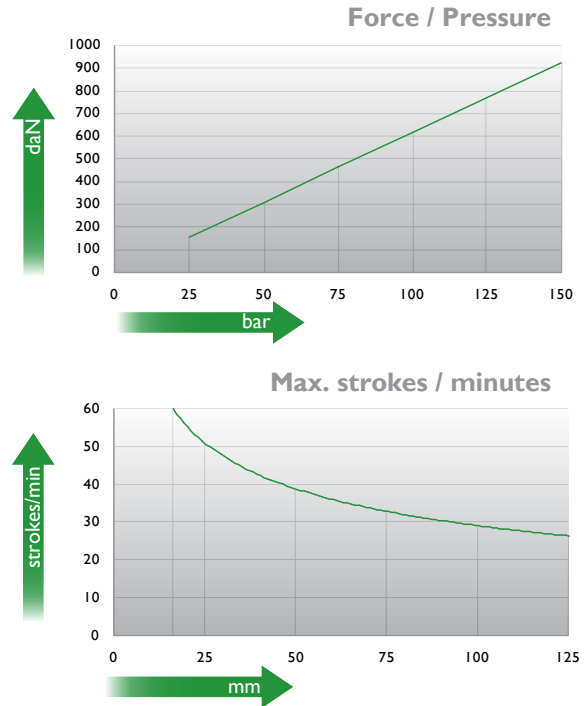
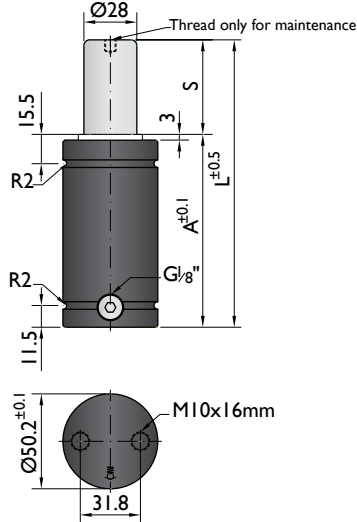

Ordering example: 4 x NT-1000-125

Order No.	S <sup>(1)</sup> mm	L mm	A mm	F <sub>0</sub> <sup>(2)</sup> daN (20°C, 150 bar)	F daN	 <sup>(3)</sup>	kg
NT-1000-13	13	78	65	920	1300	No	0.70
NT-1000-16	16	84	68		1300	No	0.76
NT-1000-19	19	90	71		1300	No	0.80
NT-1000-25	25	102	77		1300	No	0.84
NT-1000-32	32	116	84		1300	No	0.90
NT-1000-38	38	128	90		1400	No	0.96
NT-1000-50	50	152	102		1400	Yes	1.06
NT-1000-63	63	178	115		1400	Yes	1.18
NT-1000-75	75	202	127		1400	Yes	1.28
NT-1000-80	80	212	132		1400	Yes	1.35
NT-1000-100	100	252	152	1400	Yes	1.40	
NT-1000-125	125	302	177	1400	Yes	1.49	

<sup>(1)</sup> other strokes under request

<sup>(2)</sup> alternative forces upon request

<sup>(3)</sup> ESK available for other strokes



Pressure medium	N <sub>2</sub>	Working temperature	0-80°C	Min. security stroke	10%
Max. Charging pressure	150 bar	Temperature related force increase	+0.34%/°C	Repair Kit	KIT NT-1000
Min. Charging pressure	25 bar	Max. working speed	1.6 m/s	Linkable	G1/8"

### Mounting possibilities

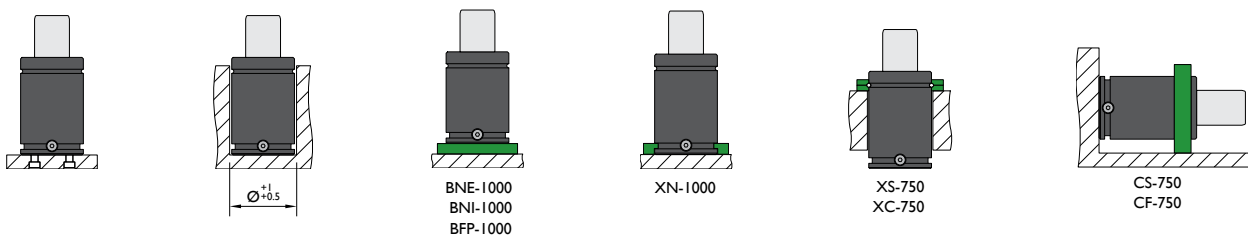

Flange must not support spring's force

## Flanges

**BNE-1000**

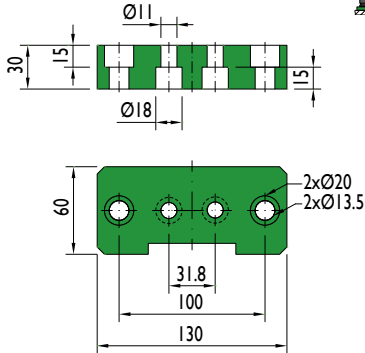

**BNI-1000**

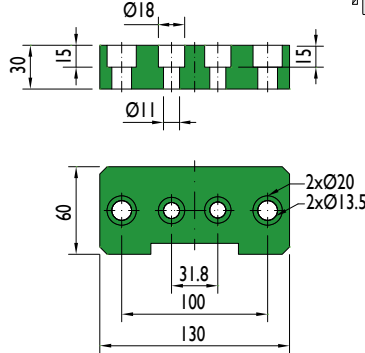

**BFP-1000**

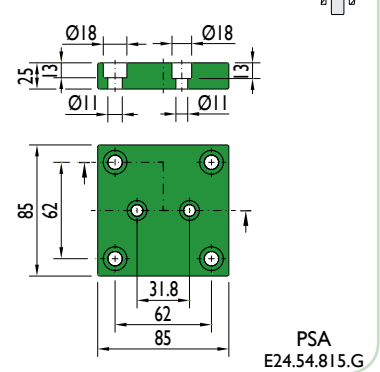

**XN-1000**

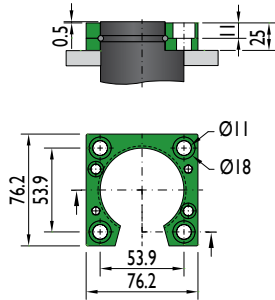

**XS-750**

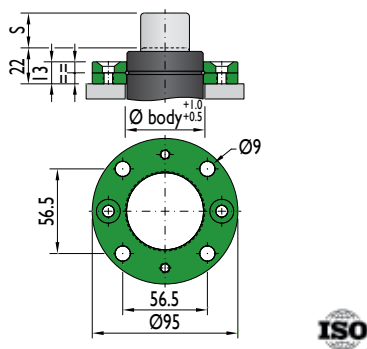

**XC-750**

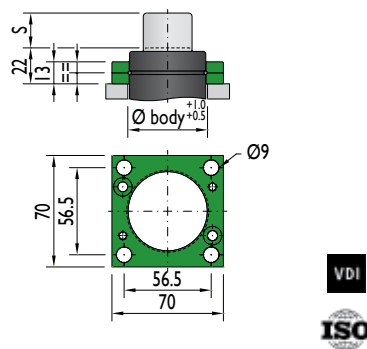

**CS-750**

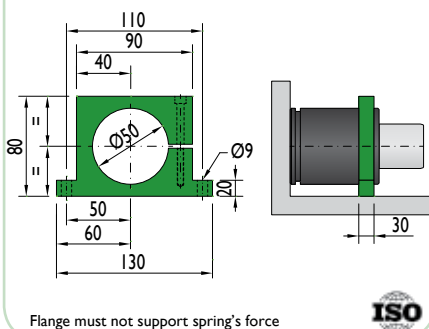

**CF-750**

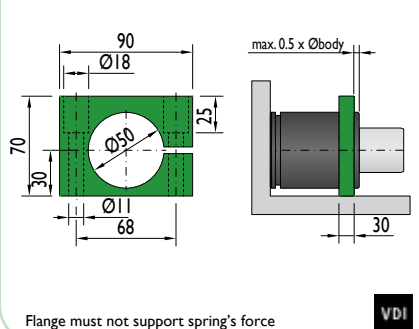



\*The new cylinder will be supplied when the stock runs out.

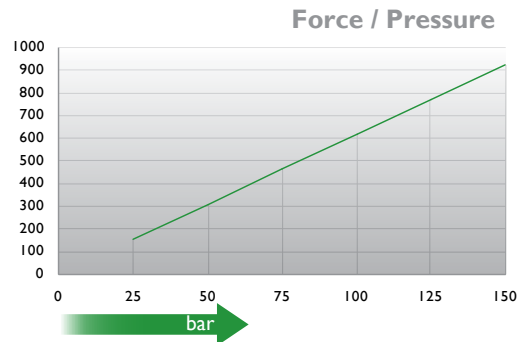
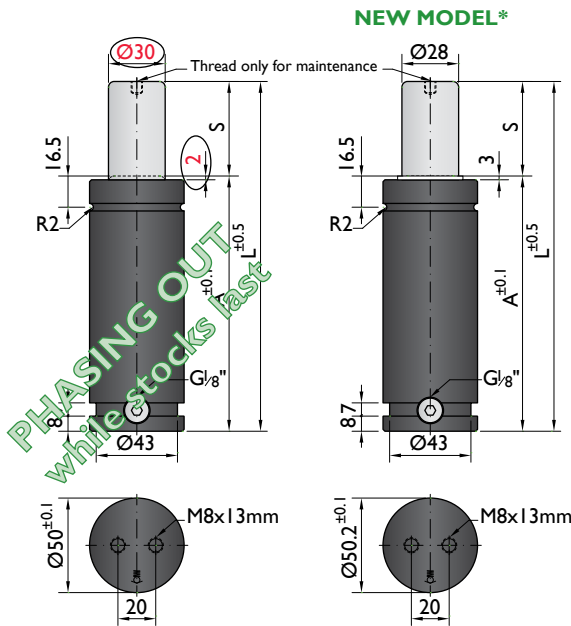

↑ daN

→ bar

↑ strokes/min

→ mm

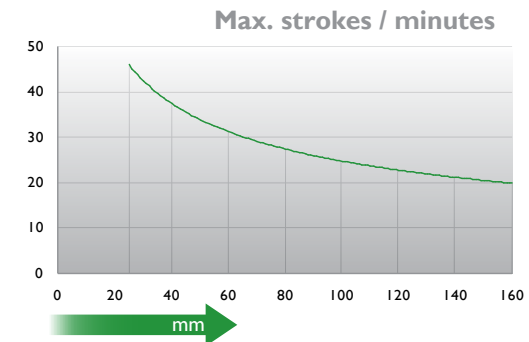

Ordering example: 4 x M-1000-125

Order No.	S <sup>(1)</sup> mm	L mm	A mm	F <sub>0</sub> <sup>(2)</sup> daN (20°C, 150 bar)	F daN	Linkable <sup>(3)</sup>	kg
M-1000-25	25	135	110	920	1300	No	1.18
M-1000-38	38	161	123		1400	No	1.30
M-1000-50	50	185	135		1400	No	1.43
M-1000-63	63	211	148		1500	No	1.55
M-1000-80	80	245	165		1500	Yes	1.92
M-1000-100	100	295	195		1500	Yes	2.17
M-1000-125	125	345	220		1600	Yes	2.40
M-1000-160	160	415	255		1600	Yes	2.79

other strokes <sup>(1)</sup> under request

alternative forces <sup>(2)</sup> upon request

ESK available <sup>(3)</sup> for other strokes



Pressure medium	N <sub>2</sub>	Working temperature	0-80°C	Min. security stroke	10%
Max. Charging pressure	140 bar	Temperature related force increase	+0.34%/°C	Repair Kit	KIT M-1000
Min. Charging pressure	25 bar	Max. working speed	1.6 m/s	Linkable	G1/8"

### Mounting possibilities

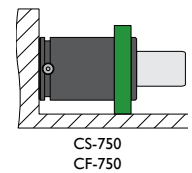
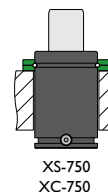
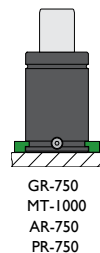
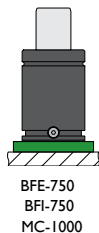
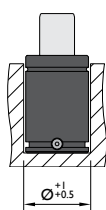
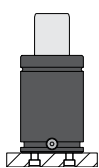

Flange must not support spring's force

## Flanges

### BFE-750

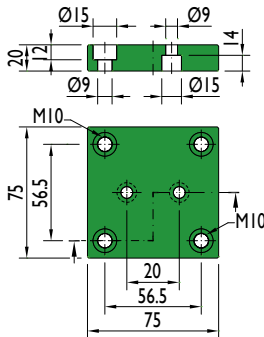

### BFI-750

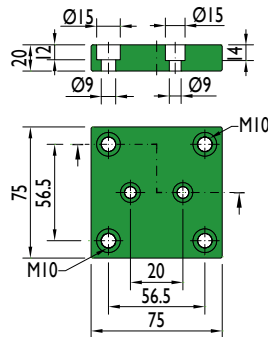

### MC-1000

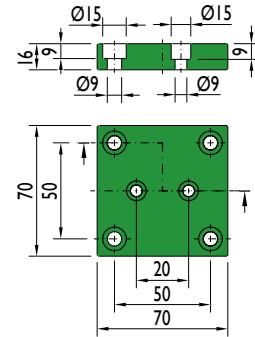

### GR-750

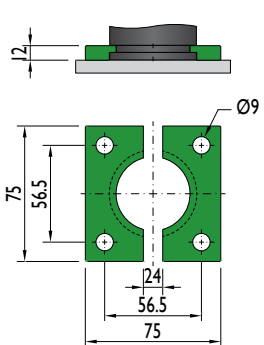

### MT-1000

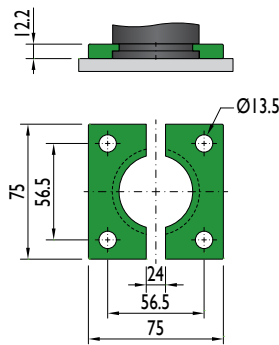

### AR-750

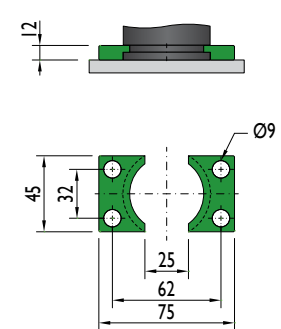

### XS-750

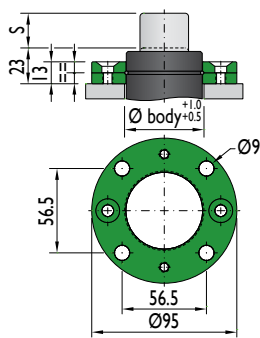

### XC-750

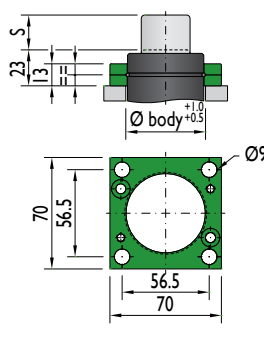

### PR-750

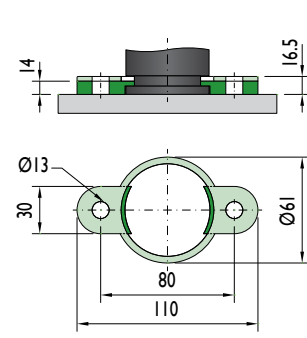

### CS-750

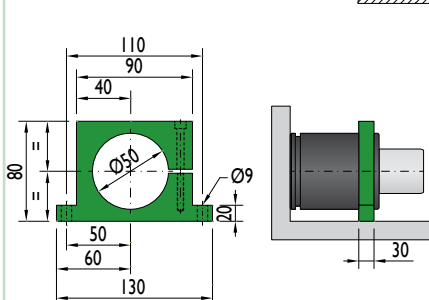

Flange must not support spring's force



### CF-750

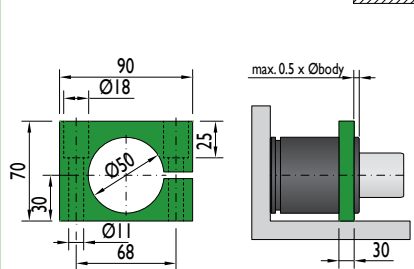

Flange must not support spring's force



Special mounts available on  
[www.nitrogas.com](http://www.nitrogas.com)





\*The new cylinder will be supplied when the stock runs out.

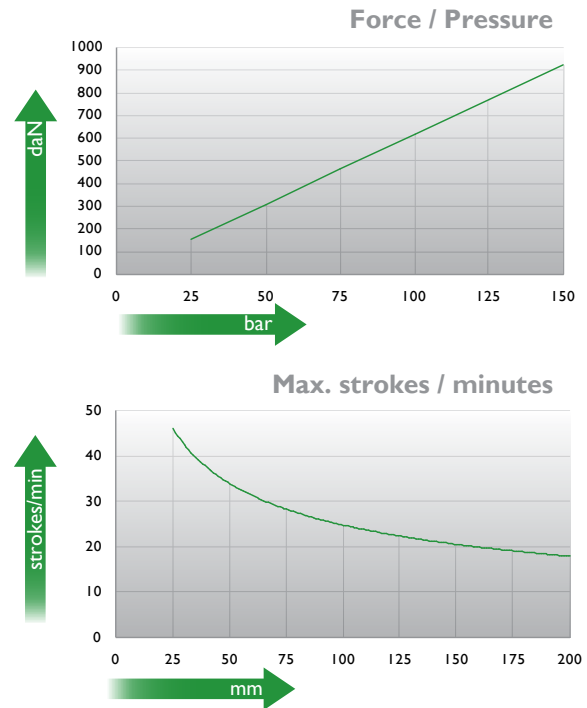
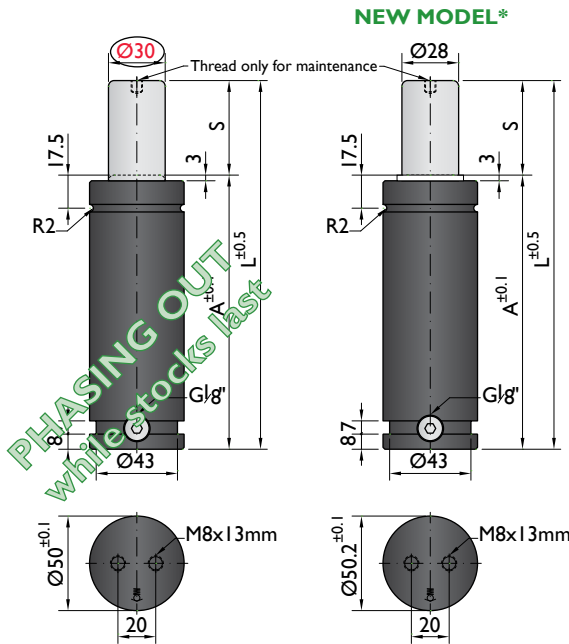

Ordering example: 4 x HD-1000-125

Order No.	S <sup>(1)</sup> mm	L mm	A mm	F <sub>0</sub> <sup>(2)</sup> daN	F daN		kg
				(20°C, 150 bar)			
HD-1000-25	25	145	120		1300	No	1.24
HD-1000-38	38	171	133		1400	No	1.35
HD-1000-50	50	195	145		1400	No	1.67
HD-1000-63	63	221	158		1500	No	1.78
HD-1000-80	80	255	175		1500	Yes	1.92
HD-1000-100	100	295	195	920	1500	Yes	2.06
HD-1000-125	125	345	220		1600	Yes	2.27
HD-1000-160	160	415	255		1700	Yes	2.69
HD-1000-200	200	495	295		1700	Yes	3.13
HD-1000-250	250	595	345		1800	Yes	3.56
HD-1000-300	300	695	395		1800	Yes	3.98

<sup>(1)</sup> other strokes under request

<sup>(2)</sup> alternative forces upon request

<sup>(3)</sup> ESK available for other strokes



Pressure medium	N <sub>2</sub>	Working temperature	0-80°C	Min. security stroke	10%
Max. Charging pressure	150 bar	Temperature related force increase	+0.34%/°C	Repair Kit	KIT HD-1000
Min. Charging pressure	25 bar	Max. working speed	1.6 m/s	Linkable	G1/8"

### Mounting possibilities

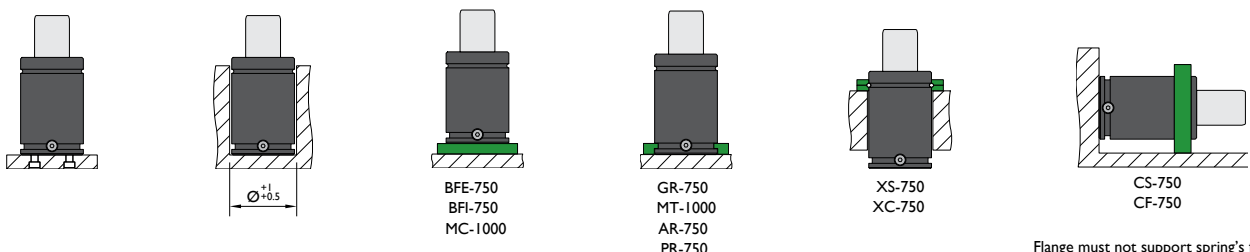

## Flanges

### BFE-750

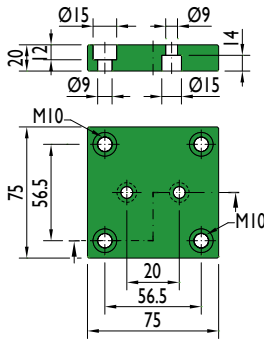

### BFI-750

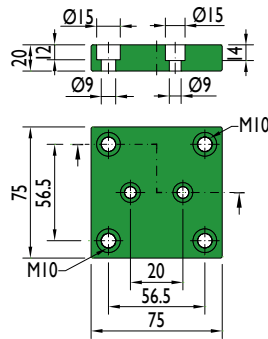

### MC-1000

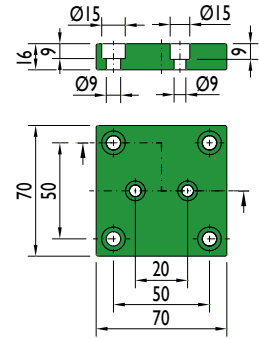

### GR-750

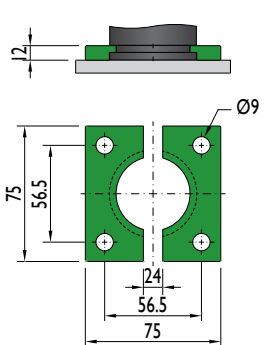

### MT-1000

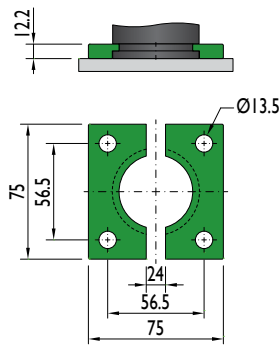

### AR-750

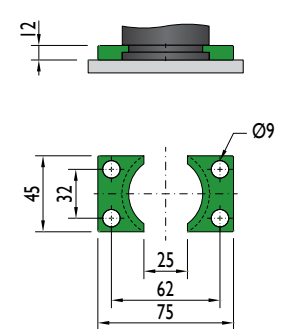

### XS-750

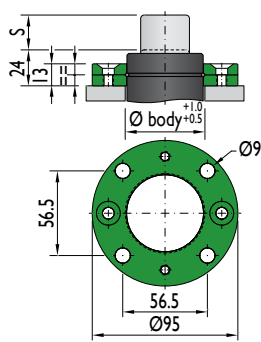

### XC-750

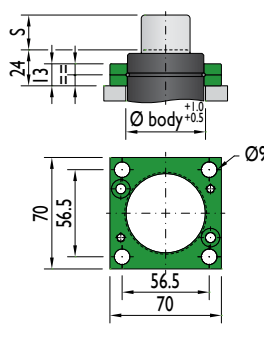

### PR-750

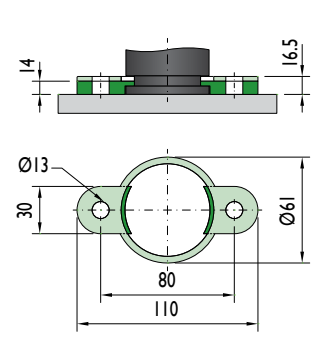

### CS-750

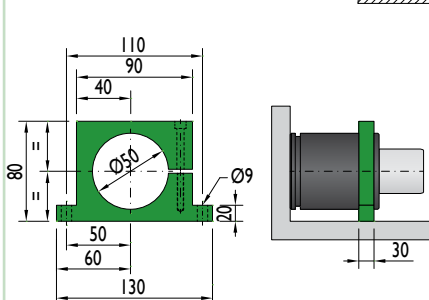

Flange must not support spring's force

### CF-750

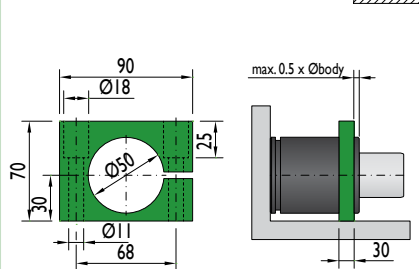

Flange must not support spring's force

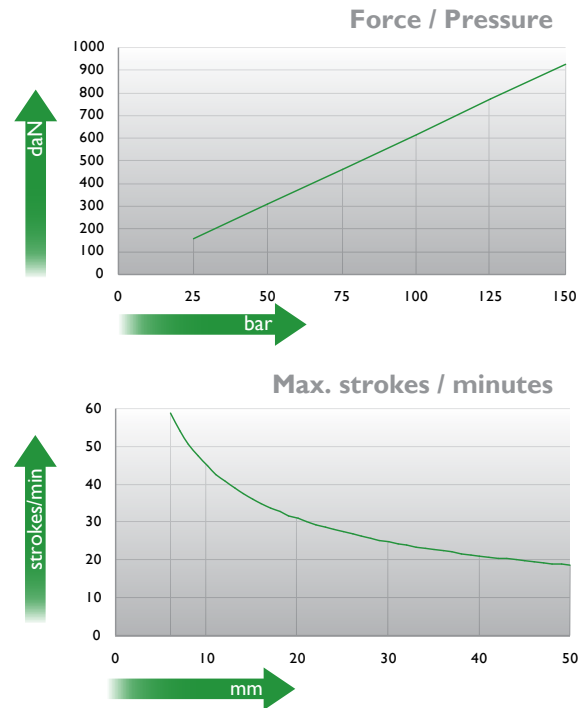
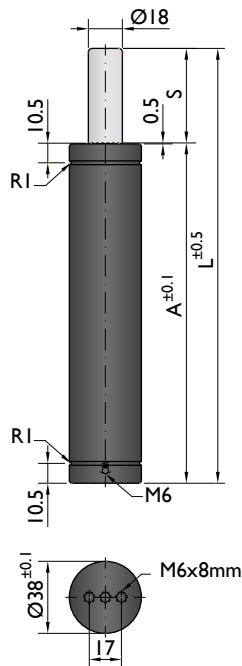

Ordering example: 4 x T-1000-50

Order No.	S <sup>(1)</sup> mm	L mm	A mm	F <sub>0</sub> <sup>(2)</sup> daN (20°C, 150 bar)	F daN		kg
T-1000-6	6	61	55	920	1300	No	0.36
T-1000-10	10	78	68		1500	No	0.44
T-1000-16	16	100	84		1400	No	0.52
T-1000-25	25	135	110		1400	No	0.63
T-1000-32	32	167	135		1400	No	0.73
T-1000-40	40	195	155		1400	No	0.81
T-1000-50	50	230	180		1400	No	0.98

other strokes <sup>(1)</sup> under request

alternative forces <sup>(2)</sup> upon request



Pressure medium	N <sub>2</sub>	Working temperature	0-80°C	Min. security stroke	10%
Max. Charging pressure	150 bar	Temperature related force increase	+0.34%/°C	Repair Kit	KIT T-1000
Min. Charging pressure	25 bar	Max. working speed	0.5 m/s	Linkable	No

### Mounting possibilities

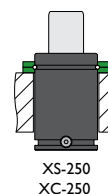
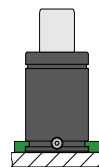
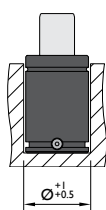
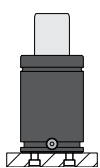

## Flanges



**XT-1000**

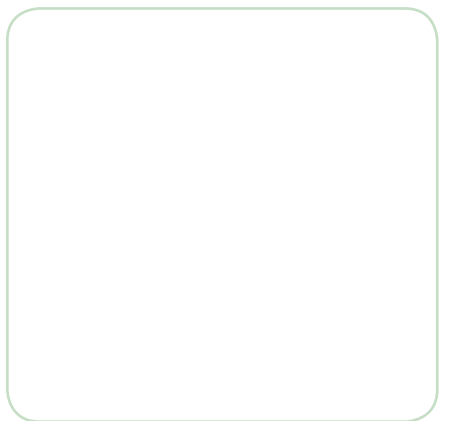
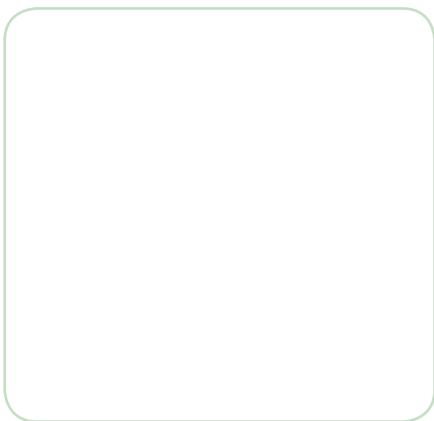

**XS-250**

ISO

**XC-250**

VDI  
ISO



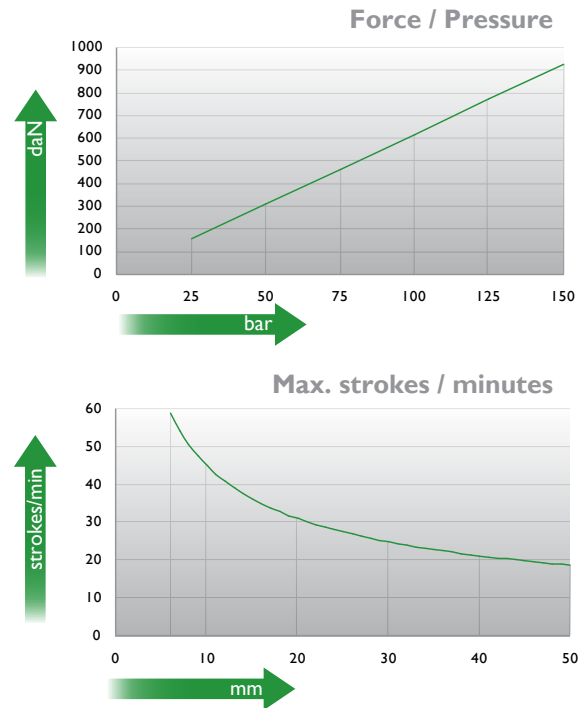
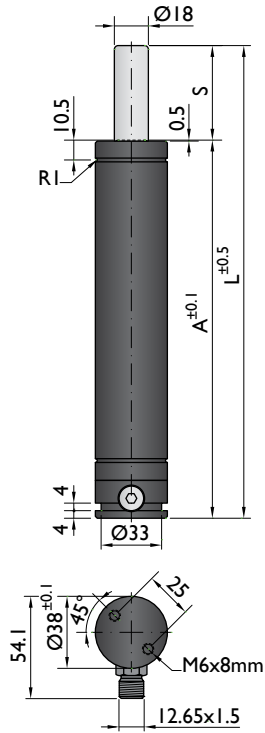

Ordering example: 4 x TC-1000-50

Order No.	S <sup>(1)</sup> mm	L mm	A mm	F <sub>0</sub> <sup>(2)</sup> daN (20°C, 150 bar)	F daN		kg
TC-1000-6	6	81	75	920	1300	No	0.50
TC-1000-10	10	98	88		1500	No	0.58
TC-1000-16	16	120	104		1400	No	0.66
TC-1000-25	25	155	130		1400	No	0.77
TC-1000-32	32	187	155		1400	No	0.87
TC-1000-40	40	215	175		1400	No	0.95
TC-1000-50	50	250	200		1400	No	1.12

other strokes <sup>(1)</sup> under request

alternative forces <sup>(2)</sup> upon request



Pressure medium	N <sub>2</sub>	Working temperature	0-80°C	Min. security stroke	10%
Max. Charging pressure	150 bar	Temperature related force increase	+0.34%/°C	Repair Kit	KIT TC-1000
Min. Charging pressure	25 bar	Max. working speed	0.5 m/s	Linkable	G1/8"

### Mounting possibilities

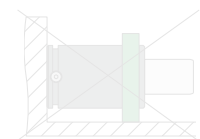
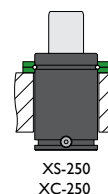
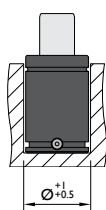
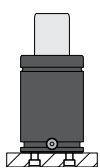

## Flanges



**XS-250**

**XC-250**



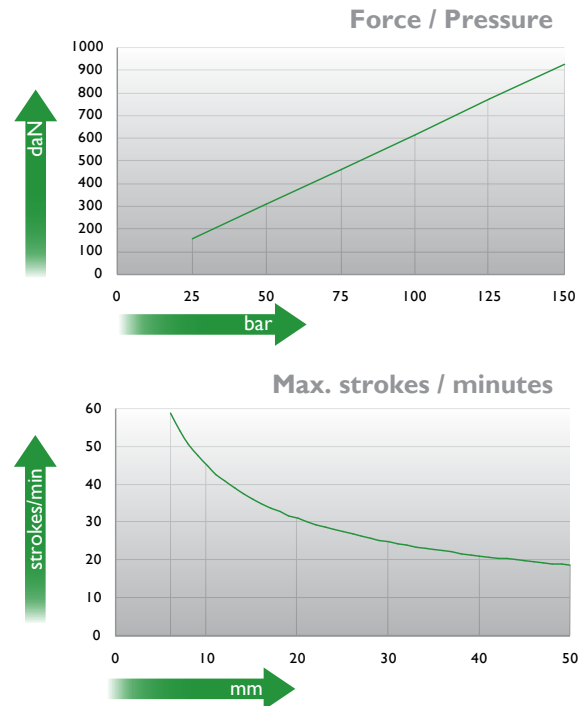
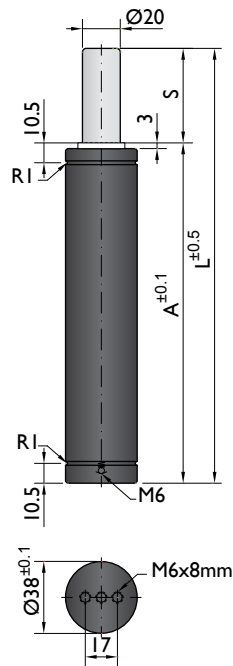

Ordering example: 4 x TS-1000-50

Order No.	S <sup>(1)</sup> mm	L mm	A mm	F <sub>0</sub> <sup>(2)</sup> daN (20°C, 150 bar)	F daN		kg
TS-1000-6	6	61	55		1300	No	0.36
TS-1000-10	10	78	68		1500	No	0.44
TS-1000-16	16	100	84		1400	No	0.52
TS-1000-25	25	135	110	920	1400	No	0.63
TS-1000-32	32	167	135		1400	No	0.73
TS-1000-40	40	195	155		1400	No	0.81
TS-1000-50	50	230	180		1400	No	0.98

other strokes <sup>(1)</sup> under request

alternative forces <sup>(2)</sup> upon request



Pressure medium	N <sub>2</sub>	Working temperature	0-80°C	Min. security stroke	10%
Max. Charging pressure	150 bar	Temperature related force increase	+0.34%/°C	Repair Kit	KIT TS-1000
Min. Charging pressure	25 bar	Max. working speed	0.5 m/s	Linkable	No

### Mounting possibilities

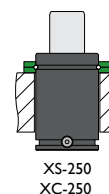
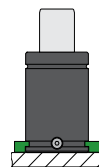
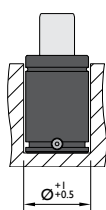
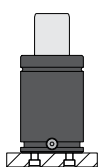

## Flanges



**XT-1000**

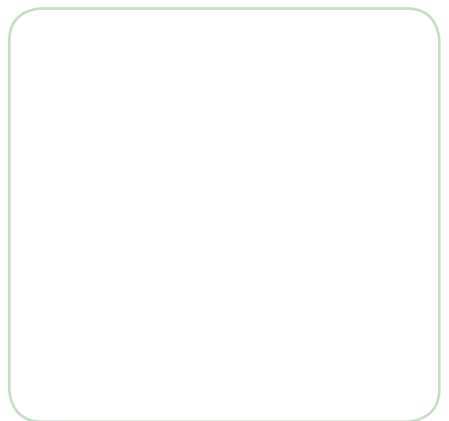
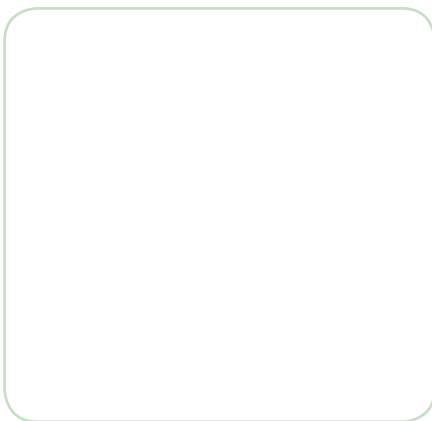

**XS-250**

**XC-250**





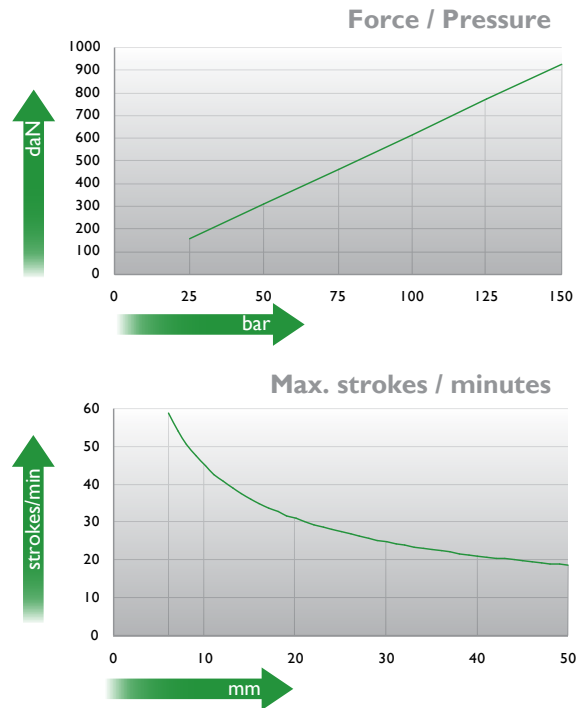
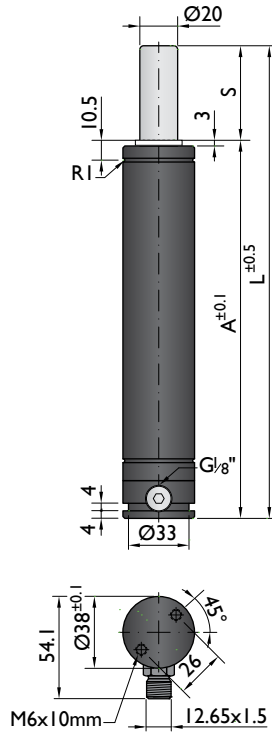

Ordering example: 4 x TSC-1000-50

Order No.	S <sup>(1)</sup> mm	L mm	A mm	F <sub>0</sub> <sup>(2)</sup> daN	F daN		kg
				(20°C, 150 bar)			
TSC-1000-6	6	81	75		1300	No	0.50
TSC-1000-10	10	98	88		1500	No	0.58
TSC-1000-16	16	120	104		1400	No	0.66
TSC-1000-25	25	155	130	920	1400	No	0.77
TSC-1000-32	32	187	155		1400	No	0.87
TSC-1000-40	40	215	175		1400	No	0.95
TSC-1000-50	50	250	200		1400	No	1.12

other strokes <sup>(1)</sup> under request

alternative forces <sup>(2)</sup> upon request



Pressure medium	N <sub>2</sub>	Working temperature	0-80°C	Min. security stroke	10%
Max. Charging pressure	150 bar	Temperature related force increase	+0.34%/°C	Repair Kit	KIT TSC-1000
Min. Charging pressure	25 bar	Max. working speed	0.5 m/s	Linkable	G1/8"

### Mounting possibilities

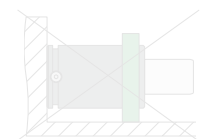
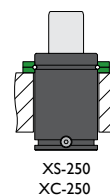
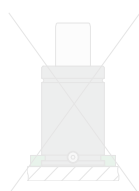
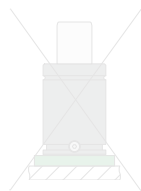
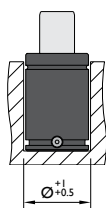
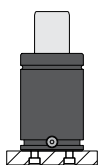

## Flanges



**XS-250**

Technical drawing of the XS-250 flange. The side view shows a height of 15 mm, a shoulder height of 9 mm, and a total height of S. The top view shows an outer diameter of Ø68, an inner diameter of Ø body +0.5, and a hole diameter of Ø7. The ISO logo is present in the bottom right corner.

**XC-250**

Technical drawing of the XC-250 flange. The side view shows a height of 15 mm, a shoulder height of 9 mm, and a total height of S. The top view shows an outer diameter of 52 mm, an inner diameter of 40 mm, and a hole diameter of Ø7. The VDI and ISO logos are present in the bottom right corner.



## Force 1500 daN

### Piston Rod Sealed gas springs

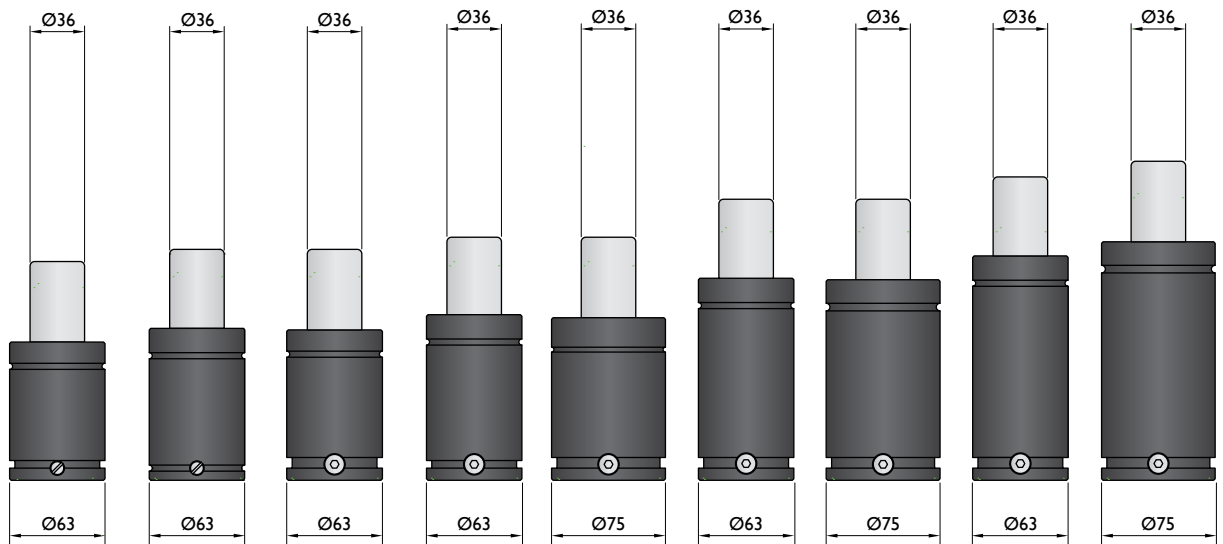
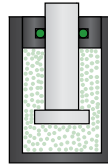

Model	KP-1500	KC-1500	NR-1500	K-1500	KH-1500	M-1500	HG-1500	HD-1500	G-1500
Initial F (daN)	1500	1500	1500	1500	1500	1500	1500	1500	1500
L max (mm)	2xStroke+44	2xStroke+52	2xStroke+52	2xStroke+60	2xStroke+60	2xStroke+85	2xStroke+85	2xStroke+95	2xStroke+110
Stroke (mm)	13-125	12-125	13-125	12-125	25-125	25-160	25-200	25-300	25-300

\* other strokes under request

### Standards

PED	PED	PED	PED	PED	PED	PED	PED	PED
97/23/EC	97/23/EC	97/23/EC	97/23/EC	97/23/EC	97/23/EC	97/23/EC	97/23/EC	97/23/EC
ISO 11901	ISO 11901	ISO 11901	ISO 11901	ISO 11901	ISO 11901	ISO 11901	ISO 11901	ISO 11901
VDI 3003	VDI 3003	VDI 3003	VDI 3003	VDI 3003	VDI 3003	VDI 3003	VDI 3003	VDI 3003
CNOMO EM24.54.700	CNOMO EM24.54.700	CNOMO EM24.54.700	CNOMO EM24.54.700	CNOMO EM24.54.700	CNOMO EM24.54.700	CNOMO EM24.54.700	CNOMO EM24.54.700	CNOMO EM24.54.700

## Force 1500 daN

### Bore Sealed gas springs

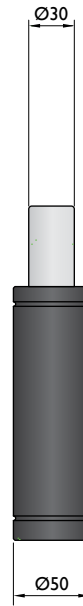
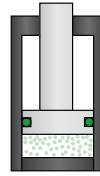

Model	T-1800	TC-1800	TS-1800	TSC-1800
Initial F (daN)	1800	1800	1800	1800
L max (mm)	66-220	86-240	66-271	86-291
Stroke (mm)	6-50	6-50	6-65	6-65

\* other strokes under request

### Standards

PED 97/23/EC	PED 97/23/EC	PED 97/23/EC	PED 97/23/EC
ISO 11901	ISO 11901	ISO 11901	ISO 11901
VDI 3003	VDI 3003	VDI 3003	VDI 3003
CNOMO EM24.54.700	CNOMO EM24.54.700	CNOMO EM24.54.700	CNOMO EM24.54.700



\*The new cylinder will be supplied when the stock runs out.

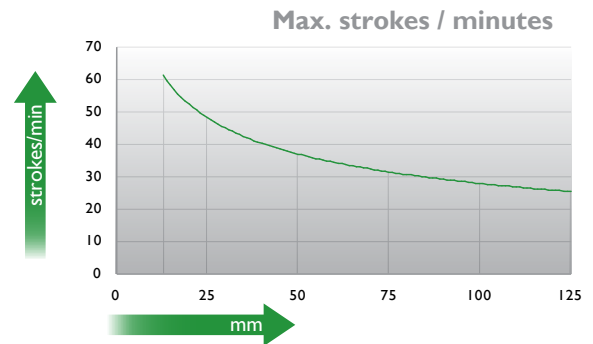
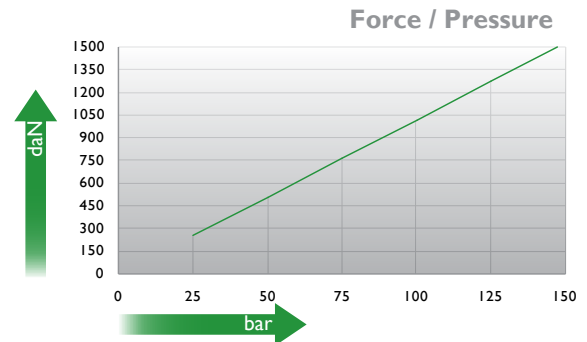
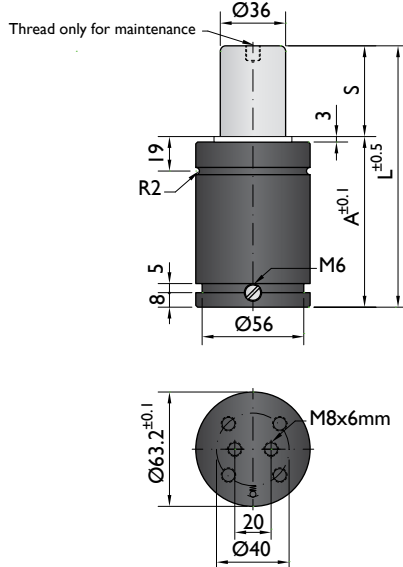

Ordering example: 4 x KP-1500-125

Order No.	S <sup>(1)</sup> mm	L mm	A mm	F <sub>0</sub> <sup>(2)</sup> daN	F daN		kg
				(20°C, 150 bar)			
KP-1500-13	13	70	57	1500	2200	No	0.94
KP-1500-16	16	76	60		2200	No	1.01
KP-1500-19	19	82	63		2200	No	1.06
KP-1500-25	25	94	69		2200	No	1.16
KP-1500-32	32	108	76		2300	No	1.27
KP-1500-38	38	120	82		2300	No	1.37
KP-1500-50	50	144	94		2400	Yes	1.57
KP-1500-63	63	170	107		2400	Yes	1.78
KP-1500-75	75	194	119		2400	Yes	1.98
KP-1500-80	80	204	124		2400	Yes	2.06
KP-1500-100	100	244	144		2400	Yes	2.37
KP-1500-125	125	294	169		2400	Yes	2.80

<sup>(1)</sup> other strokes under request

<sup>(2)</sup> alternative forces upon request

<sup>(3)</sup> ESK available for other strokes



Pressure medium N<sub>2</sub>  
 Max. Charging pressure 150 bar  
 Min. Charging pressure 25 bar

Working temperature 0-80°C  
 Temperature related force increase +0.34%/°C  
 Max. working speed 1.6 m/s

Min. security stroke 10%  
 Repair Kit KIT KP-1500  
 Linkable M6

### Mounting possibilities

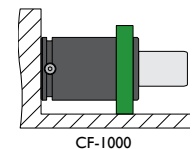
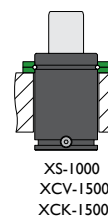
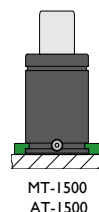
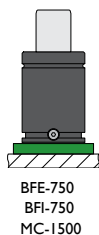
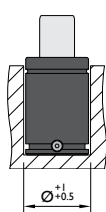
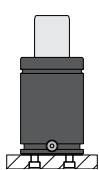

Flange must not support spring's force

## Flanges

**BFE-750**

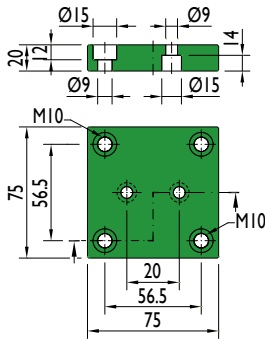

**BFI-750**

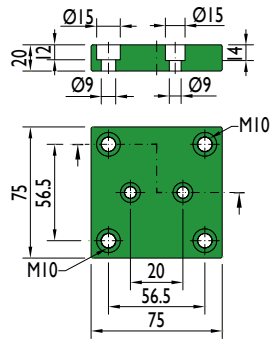

**MC-1500**

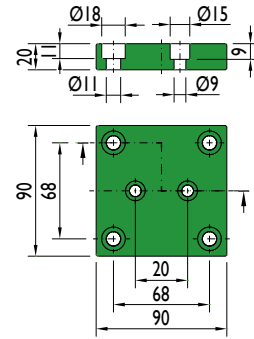

**MT-1500**

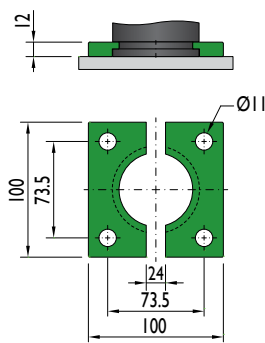

**AT-1500**

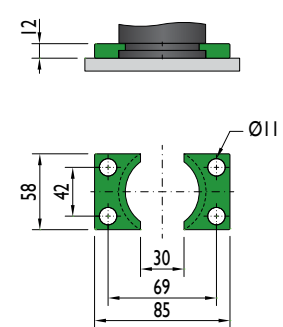

**XS-1000**

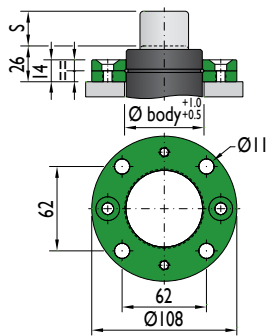

**XCV-1500**

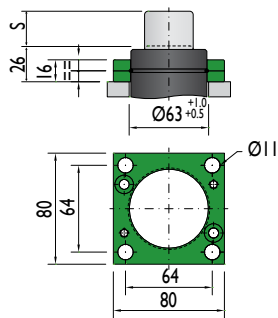

**XCK-1500**

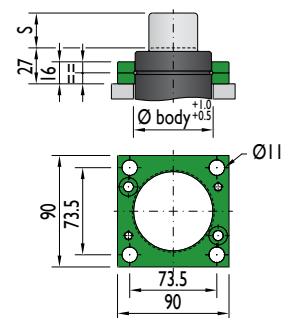

**CF-1000**

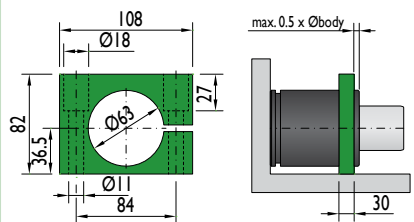

Flange must not support spring's force



\*The new cylinder will be supplied when the stock runs out.

**NEW MODEL\***

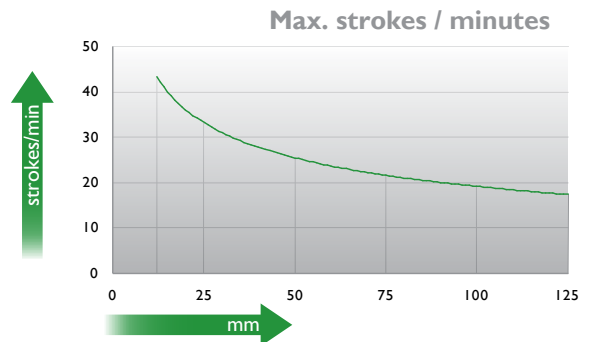
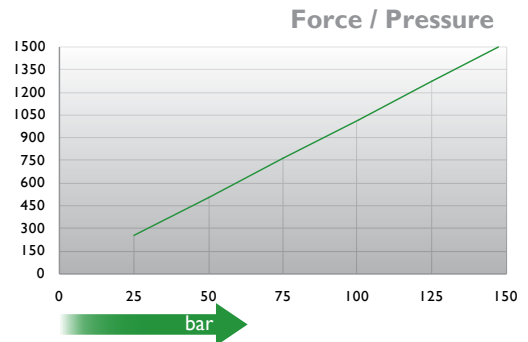
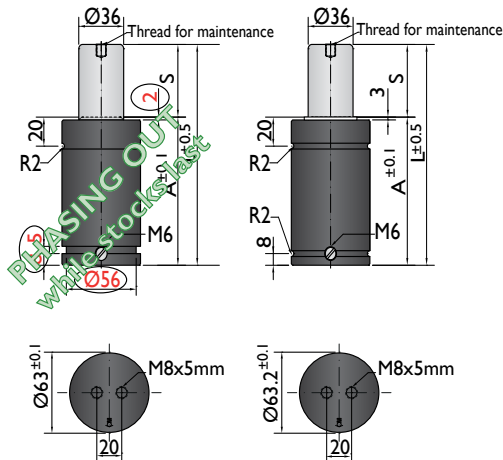

Ordering example: 4 x KC-1500-125

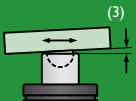
Order No.	S <sup>(1)</sup> mm	L mm	A mm	F <sub>0</sub> <sup>(2)</sup> daN (20°C, 150 bar)	F daN	 <sup>(3)</sup>	kg
KC-1500-12	12	76	64	1500	1800	No	1.02
KC-1500-25	25	102	77		2400	No	1.24
KC-1500-38	38	128	90		2500	No	1.45
KC-1500-50	50	152	102		2600	Yes	1.65
KC-1500-63	63	178	115		2700	Yes	1.86
KC-1500-80	80	212	132		2700	Yes	2.14
KC-1500-100	100	252	152		2700	Yes	2.45
KC-1500-125	125	302	177		2700	Yes	2.88

other strokes <sup>(1)</sup> under request

alternative forces <sup>(2)</sup> upon request

ESK available for other strokes <sup>(3)</sup>



Pressure medium	N <sub>2</sub>	Working temperature	0-80°C	Min. security stroke	10%
Max. Charging pressure	150 bar	Temperature related force increase	+0.34%/°C	Repair Kit	KIT KC-1500
Min. Charging pressure	25 bar	Max. working speed	1.6 m/s	Linkable	M6

**Mounting possibilities**

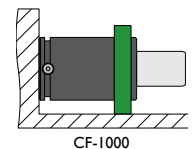
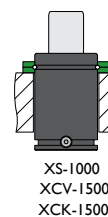
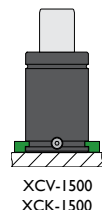
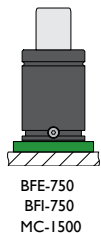
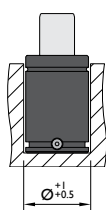
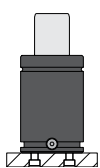

Flange must not support spring's force

## Flanges

**BFE-750**

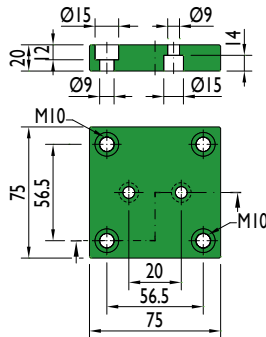

**BFI-750**

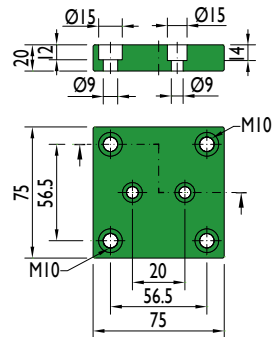

**MC-1500**

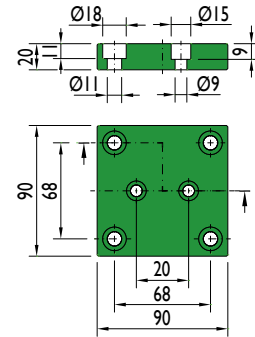

**XCV-1500**

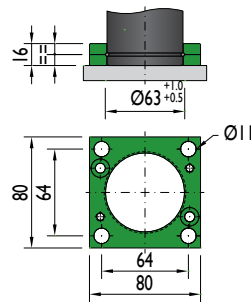

**XCK-1500**

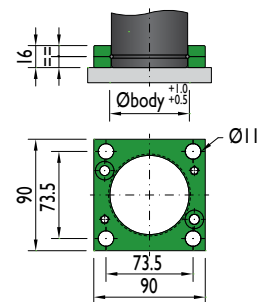

**XS-1000**

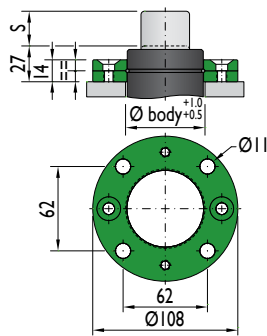

**XCV-1500**

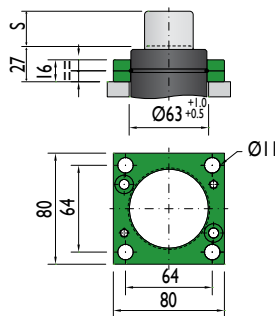

**XCK-1500**

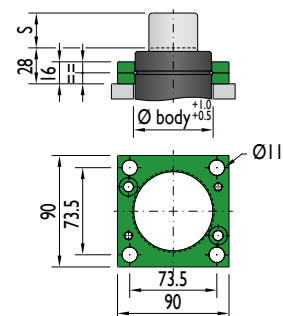

**CF-1000**

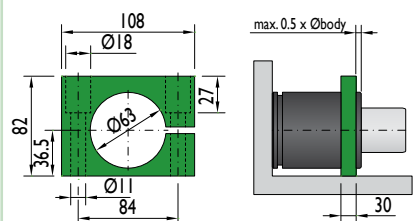

Flange must not support spring's force



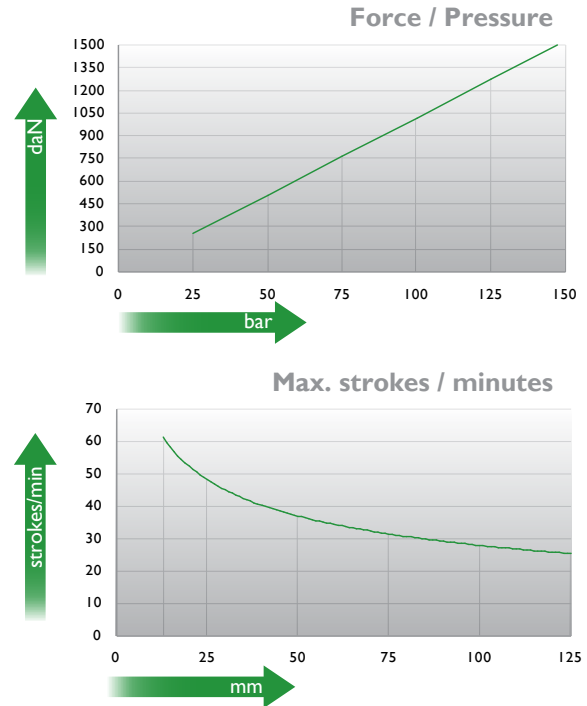
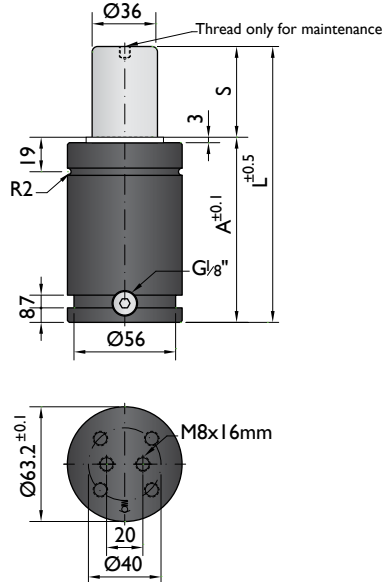

Ordering example: 4 x NR-1500-125

Order No.	S <sup>(1)</sup> mm	L mm	A mm	F <sub>0</sub> <sup>(2)</sup> daN	F daN	(3)	kg
NR-1500-13	13	78	65	1500	2100	No	0.97
NR-1500-16	16	84	68		2200	No	1.04
NR-1500-19	19	90	71		2200	No	1.09
NR-1500-25	25	102	77		2200	No	1.09
NR-1500-32	32	116	84		2300	No	1.30
NR-1500-38	38	128	90		2300	No	1.40
NR-1500-50	50	152	102		2400	Yes	1.60
NR-1500-63	63	178	115		2400	Yes	1.81
NR-1500-75	75	202	127		2400	Yes	2.01
NR-1500-80	80	212	132		2400	Yes	2.09
NR-1500-100	100	252	152		2400	Yes	2.40
NR-1500-125	125	302	177		2400	Yes	2.83

<sup>(1)</sup> other strokes under request

<sup>(2)</sup> alternative forces upon request

<sup>(3)</sup> ESK available for other strokes



Pressure medium	N <sub>2</sub>	Working temperature	0-80°C	Min. security stroke	10%
Max. Charging pressure	150 bar	Temperature related force increase	+0.34%/°C	Repair Kit	KIT NR-1500
Min. Charging pressure	25 bar	Max. working speed	1.6 m/s	Linkable	G1/8"

### Mounting possibilities

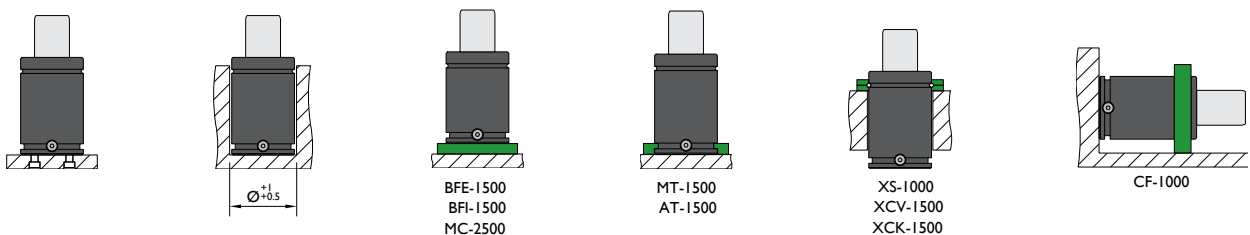

Flange must not support spring's force

## Flanges

**BFE-1500**

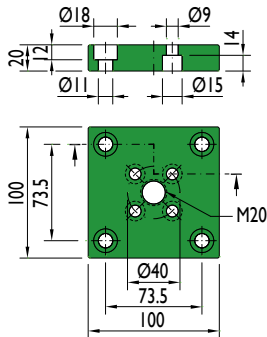

**BFI-1500**

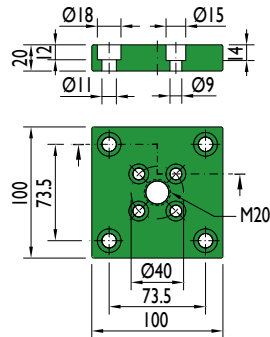

**MC-2500**

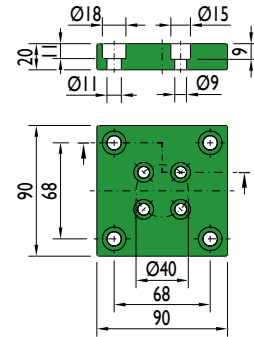

**MT-1500**

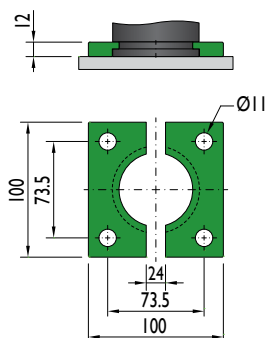

**AT-1500**

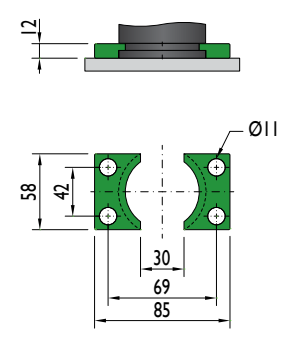

**XS-1000**

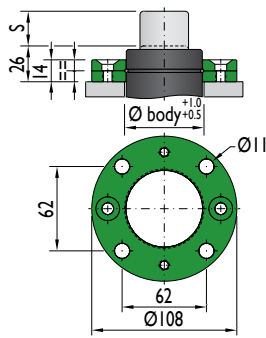

**XCV-1500**

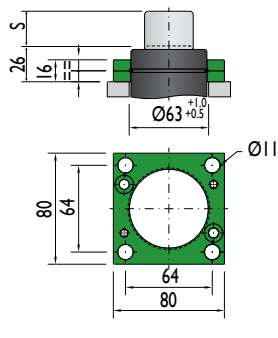

**XCK-1500**

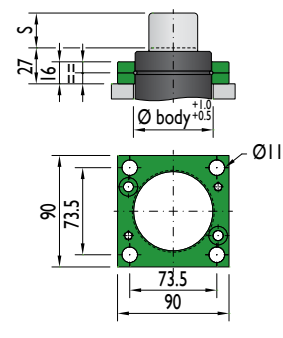

**CF-1000**

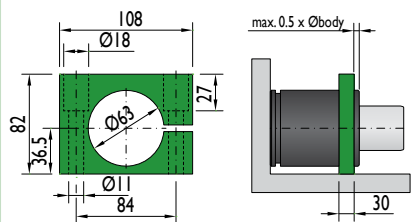

Flange must not support spring's force

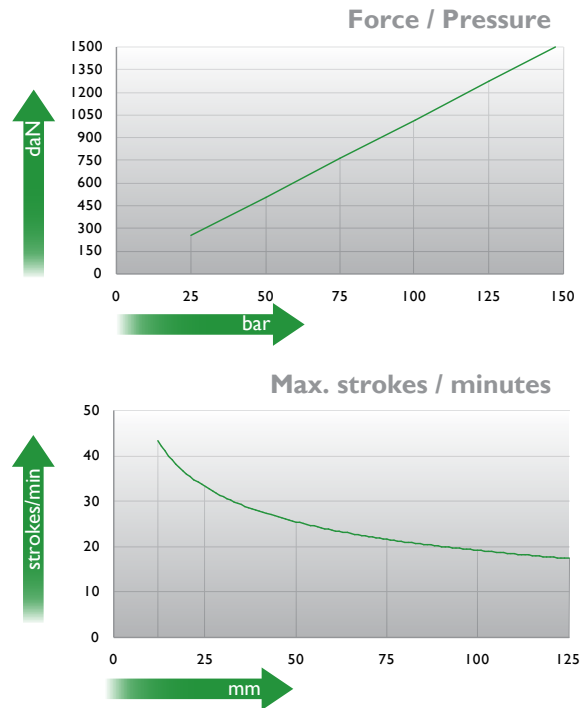
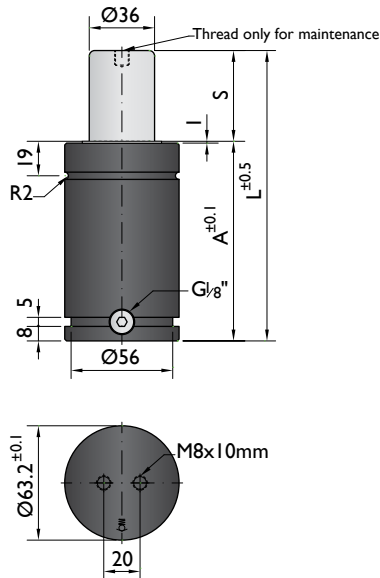

Ordering example: 4 x K-1500-125

Order No.	S <sup>(1)</sup> mm	L mm	A mm	F <sub>0</sub> <sup>(2)</sup> daN (20°C, 150 bar)	F daN	 <sup>(3)</sup>	kg
K-1500-12	12	84	72	1500	2100	No	1.32
K-1500-25	25	110	85		2300	No	1.49
K-1500-38	38	136	98		2500	No	1.60
K-1500-50	50	160	110		2600	Yes	1.85
K-1500-63	63	186	123		2600	Yes	2.01
K-1500-80	80	220	140		2600	Yes	2.27
K-1500-100	100	260	160		2600	Yes	2.60
K-1500-125	125	310	185		2600	Yes	3.04

other strokes <sup>(1)</sup> under request

alternative forces <sup>(2)</sup> upon request

ESK available for other strokes <sup>(3)</sup>



Pressure medium	N <sub>2</sub>	Working temperature	0-80°C	Min. security stroke	10%
Max. Charging pressure	150 bar	Temperature related force increase	+0.34%/°C	Repair Kit	KIT K-1500
Min. Charging pressure	25 bar	Max. working speed	1.6 m/s	Linkable	G1/8"

### Mounting possibilities

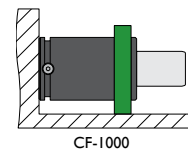
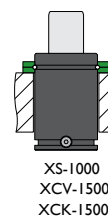
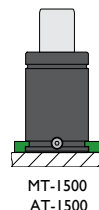
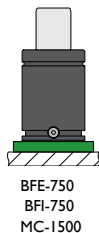
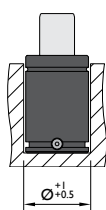
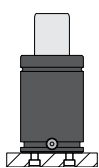

Flange must not support spring's force

## Flanges

**BFE-750**

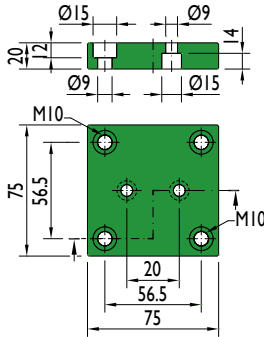

**BFI-750**

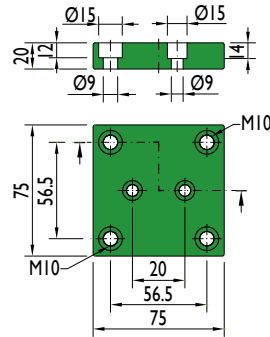

**MC-1500**

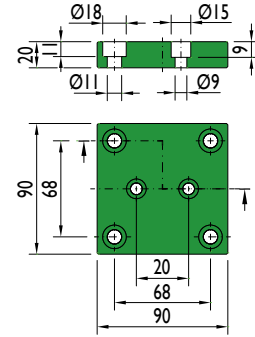

**MT-1500**

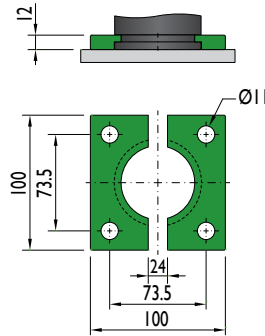

**AT-1500**

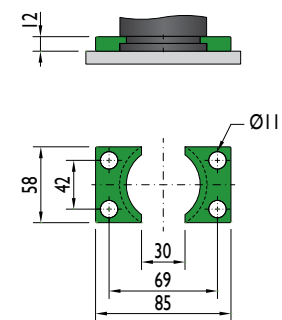

**XS-1000**

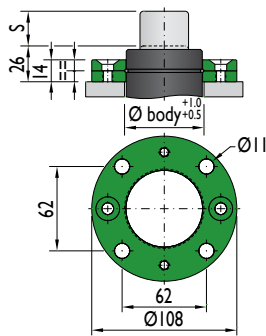

**XCV-1500**

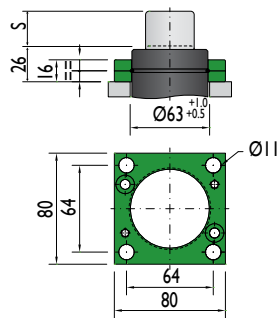

**XCK-1500**

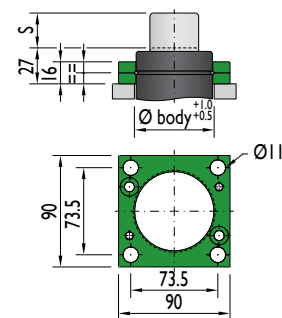

**CF-1000**

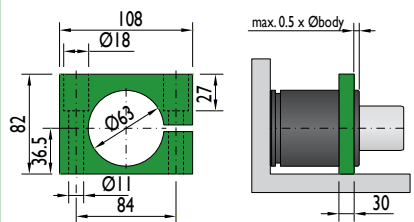

Flange must not support spring's force





CNOMO  
EM24.54.700

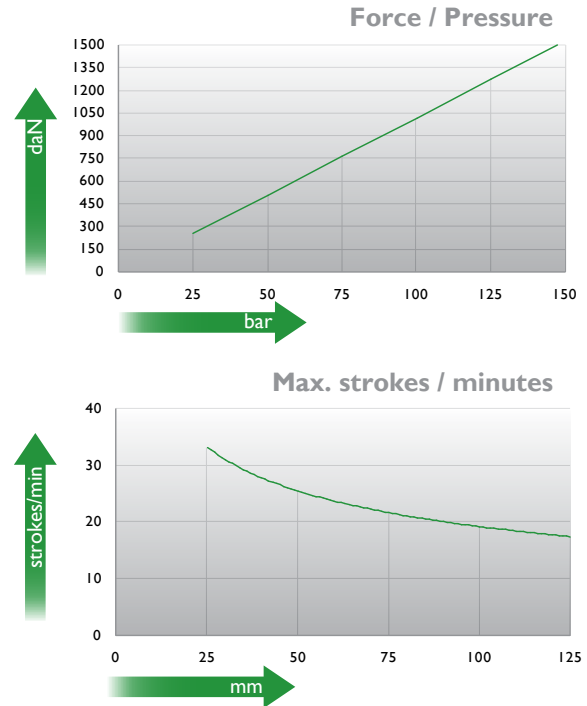
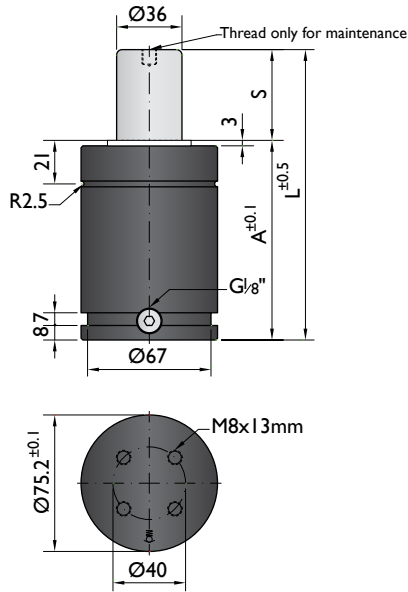

Ordering example: 4 x KH-1500-125

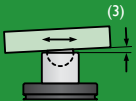
Order No.	S <sup>(1)</sup> mm	L mm	A mm	F <sub>0</sub> <sup>(2)</sup> daN (20°C, 150 bar)	F daN	 <sup>(3)</sup>	kg
<b>KH-1500-25</b>	25	110	85	1500	2100	No	2.08
<b>KH-1500-38</b>	38.1	136.2	98.1		2200	No	2.33
<b>KH-1500-50</b>	50	160	110		2300	Yes	2.50
<b>KH-1500-63</b>	63.5	187	123.5		2300	Yes	2.73
<b>KH-1500-80</b>	80	220	140		2300	Yes	3.04
<b>KH-1500-100</b>	100	260	160		2300	Yes	3.60
<b>KH-1500-125</b>	125	310	185		2300	Yes	4.75

other strokes <sup>(1)</sup> under request

alternative forces <sup>(2)</sup> upon request

ESK available for other strokes <sup>(3)</sup>



Pressure medium	N <sub>2</sub>	Working temperature	0-80°C	Min. security stroke	10%
Max. Charging pressure	150 bar	Temperature related force increase	+0.34%/°C	Repair Kit	KIT KH-1500
Min. Charging pressure	25 bar	Max. working speed	1.6 m/s	Linkable	G1/8"

### Mounting possibilities

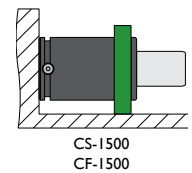
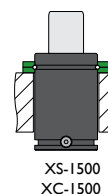
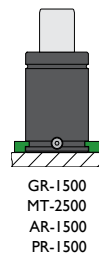
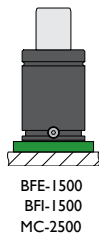
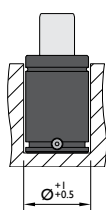
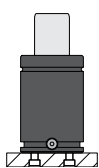

Flange must not support spring's force

## Flanges

**BFE-I500**

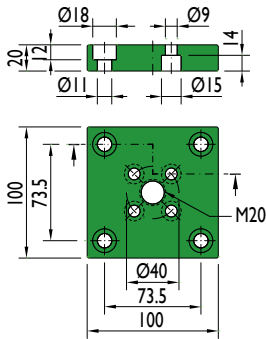

**BFI-I500**

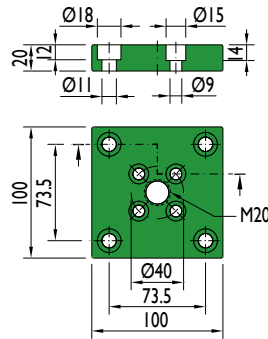

**MC-2500**

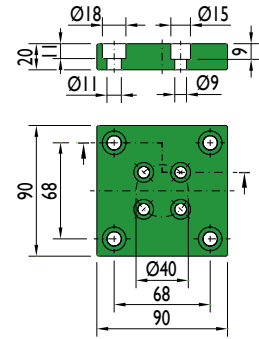

**GR-I500**

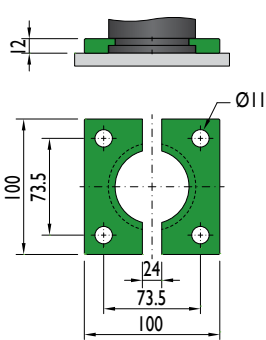

**MT-2500**

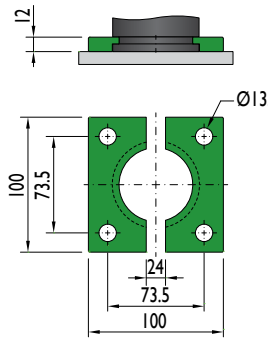

**AR-I500**

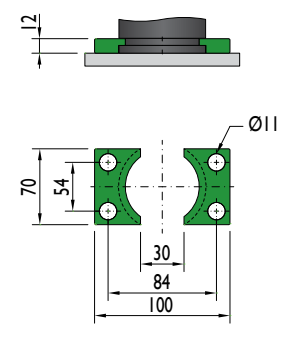

**XS-I500**

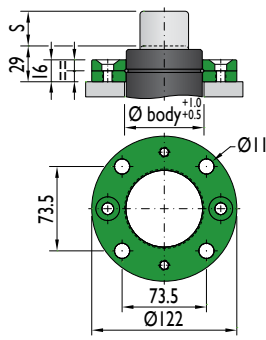

**XC-I500**

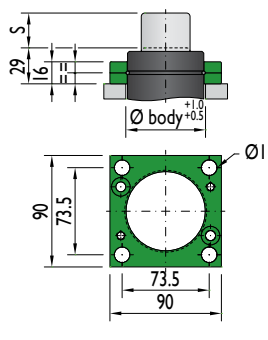

**PR-I500**

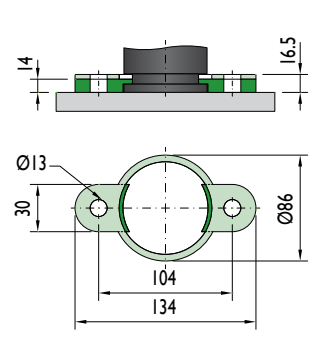

**CS-I500**

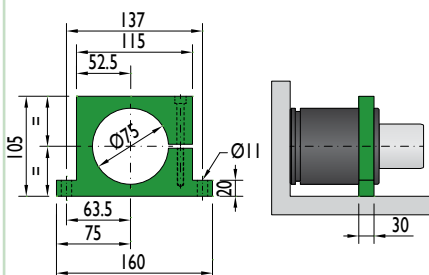

Flange must not support spring's force

**CF-I500**

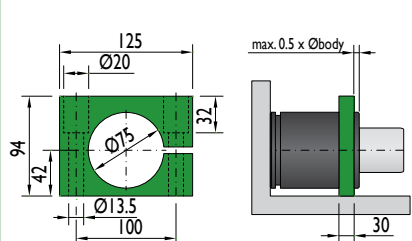

Flange must not support spring's force

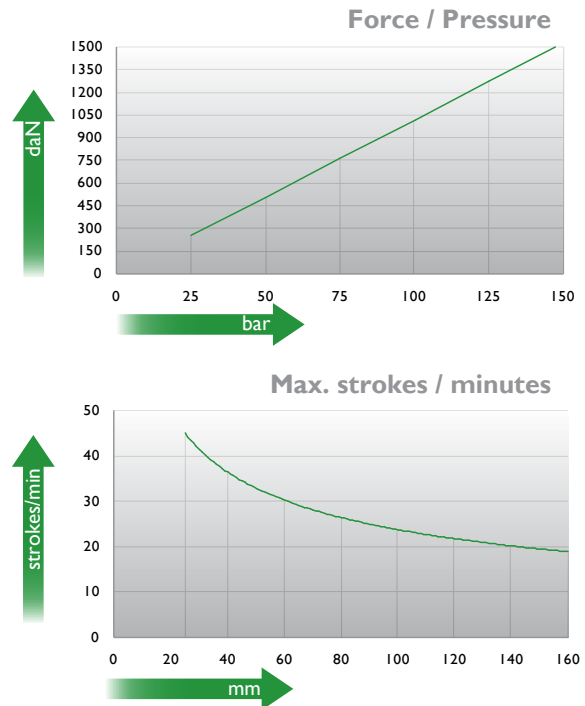
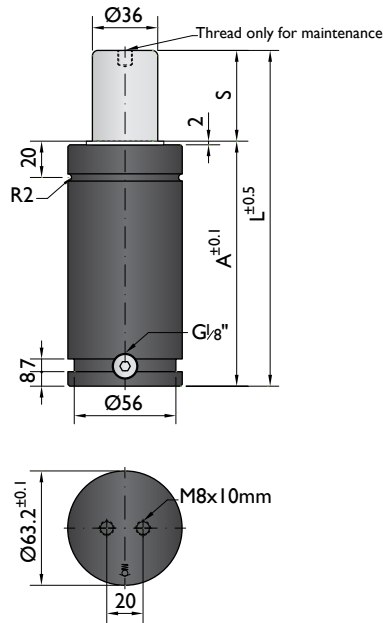

Ordering example: 4 x M-1500-125

Order No.	S <sup>(1)</sup> mm	L mm	A mm	F <sub>0</sub> <sup>(2)</sup> daN (20°C, 150 bar)	F daN	 <sup>(3)</sup>	kg
M-1500-25	25	135	110	1500	2200	No	1.88
M-1500-38	38	161	123		2400	No	2.15
M-1500-50	50	185	135		2400	No	2.25
M-1500-63	63	211	148		2500	No	2.50
M-1500-80	80	245	165		2500	Yes	2.58
M-1500-100	100	285	185		2500	Yes	2.85
M-1500-125	125	345	220		2500	Yes	3.32
M-1500-160	160	415	255		2500	Yes	3.77

other strokes <sup>(1)</sup> under request

alternative forces upon request <sup>(2)</sup>

ESK available for other strokes <sup>(3)</sup>



Pressure medium	N <sub>2</sub>	Working temperature	0-80°C	Min. security stroke	10%
Max. Charging pressure	150 bar	Temperature related force increase	+0.34%/°C	Repair Kit	KIT M-1500
Min. Charging pressure	25 bar	Max. working speed	1.6 m/s	Linkable	G1/8"

### Mounting possibilities

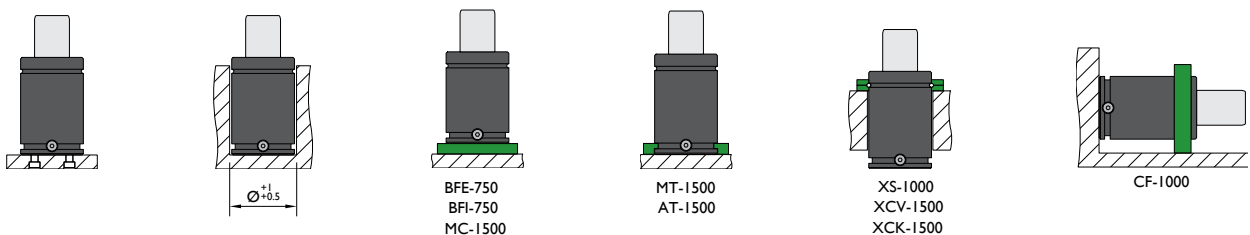

## Flanges

### BFE-750

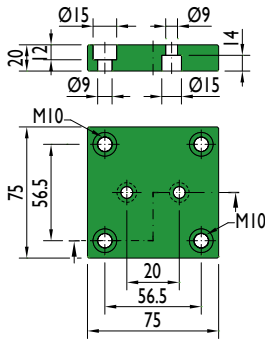

### BFI-750

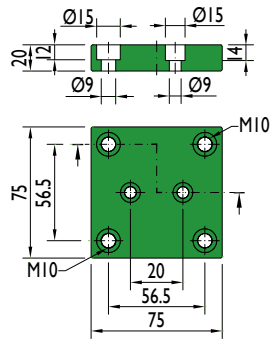

### MC-1500

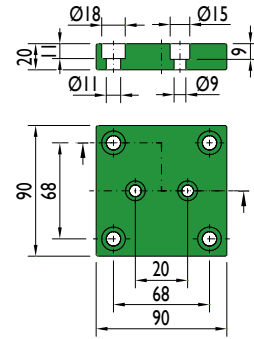

### MT-1500

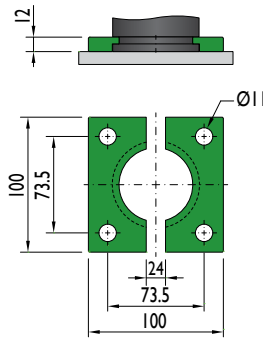

### AT-1500

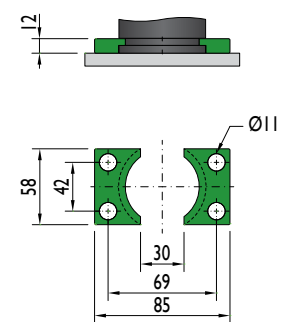

### XS-1000

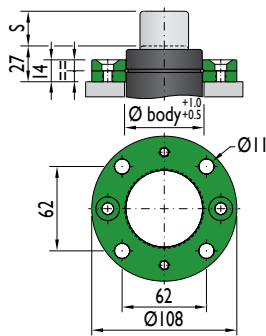

### XCV-1500

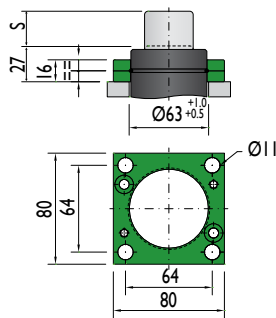

### XCK-1500

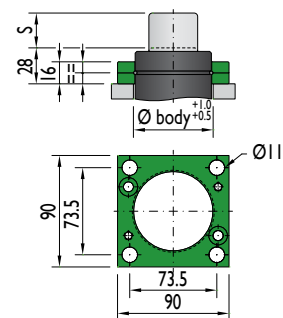

### CF-1000

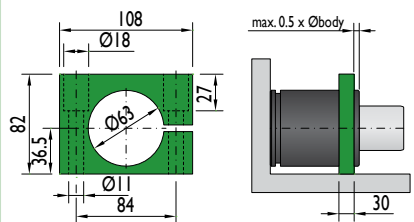

Flange must not support spring's force



Special mounts available on  
[www.nitrogas.com](http://www.nitrogas.com)



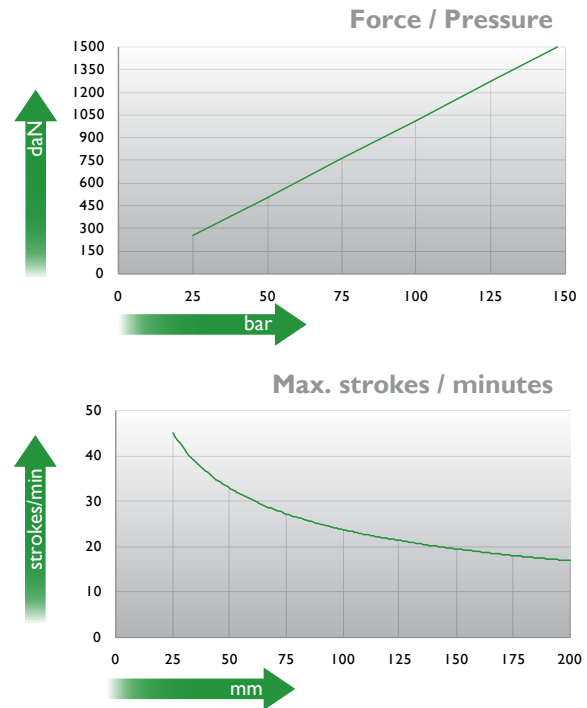
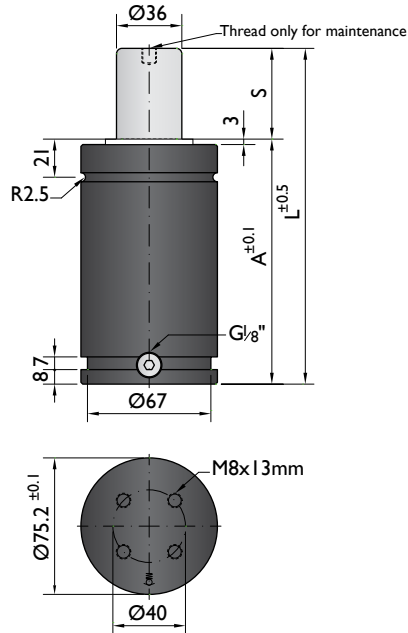

Ordering example: 4 x HG-1500-125

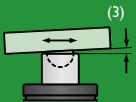
Order No.	S <sup>(1)</sup> mm	L mm	A mm	F <sub>0</sub> <sup>(2)</sup> daN (20°C, 150 bar)	F daN	 <sup>(3)</sup>	kg
HG-1500-25	25	135	110	1500	1900	No	2.95
HG-1500-38	37.5	160	122.5		2000	No	3.18
HG-1500-50	50	185	135		2000	No	3.41
HG-1500-63	62.5	210	147.5		2000	No	3.64
HG-1500-80	80	245	165		2100	Yes	3.95
HG-1500-100	100	285	185		2100	Yes	4.33
HG-1500-125	125	335	210		2100	Yes	4.78
HG-1500-160	160	405	245		2200	Yes	5.43
HG-1500-200	200	485	285	2200	Yes	6.15	

<sup>(1)</sup> other strokes under request

<sup>(2)</sup> alternative forces upon request

<sup>(3)</sup> ESK available for other strokes



Pressure medium	N <sub>2</sub>	Working temperature	0-80°C	Min. security stroke	10%
Max. Charging pressure	150 bar	Temperature related force increase	+0.34%/°C	Repair Kit	KIT HG-1500
Min. Charging pressure	25 bar	Max. working speed	1.6 m/s	Linkable	G1/8"

### Mounting possibilities

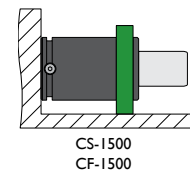
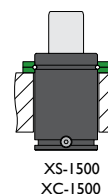
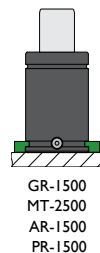
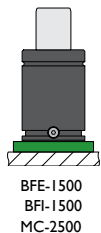
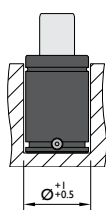
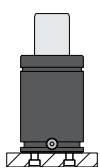

Flange must not support spring's force

## Flanges

### BFE-I500

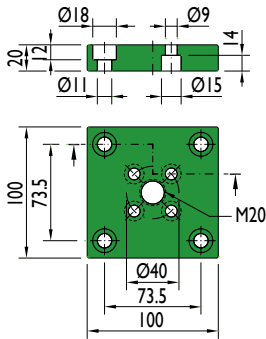

### BFI-I500

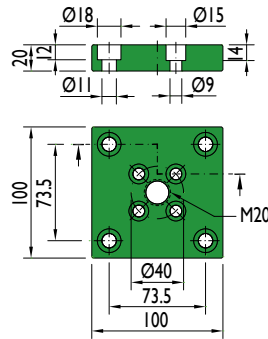

### MC-2500

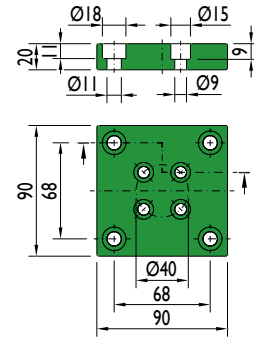

### GR-I500

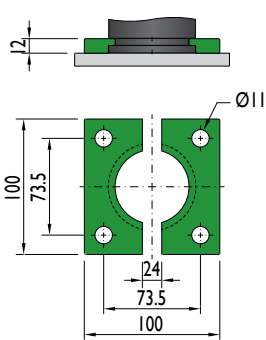

### MT-2500

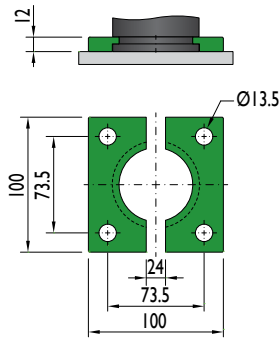

### AR-I500

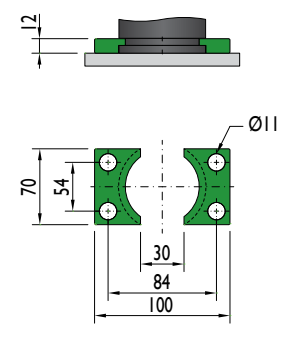

### XS-I500

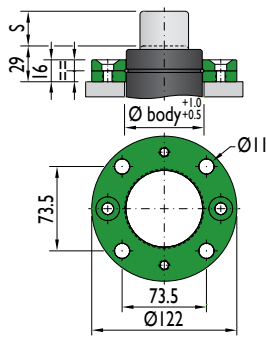

### XC-I500

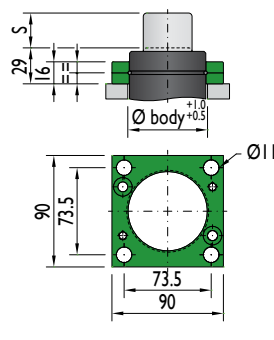

### PR-I500

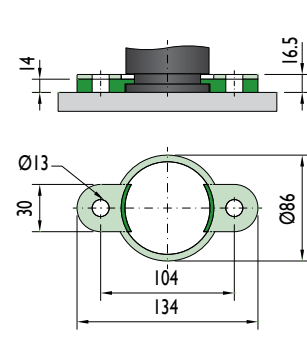

### CS-I500

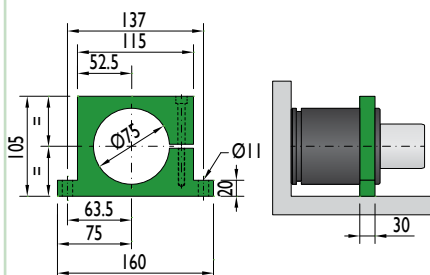

Flange must not support spring's force

### CF-I500

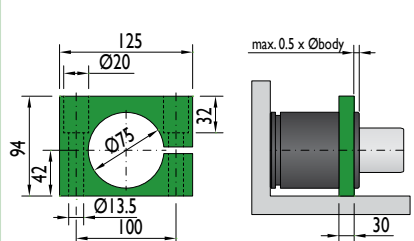

Flange must not support spring's force

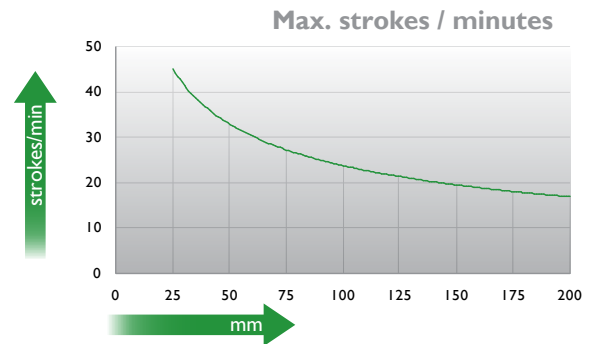
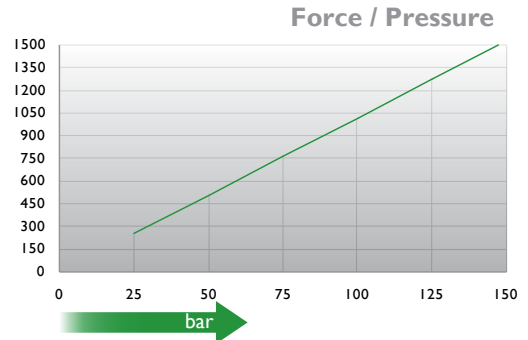
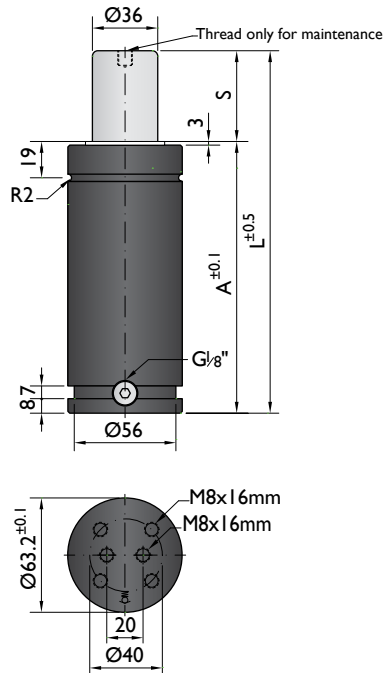

Ordering example: 4 x HD-1500-125

Order No.	S <sup>(1)</sup> mm	L mm	A mm	F <sub>0</sub> <sup>(2)</sup> daN (20°C, 150 bar)	F daN	ESK available (3)	kg
HD-1500-25	25	145	120	1500	2000	No	1.89
HD-1500-38	38	171	133		2000	No	2.16
HD-1500-50	50	195	145		2100	No	2.26
HD-1500-63	63	221	158		2200	No	2.51
HD-1500-80	80	255	175		2300	Yes	2.59
HD-1500-100	100	295	195		2300	Yes	2.86
HD-1500-125	125	345	220		2400	Yes	3.33
HD-1500-160	160	415	255		2400	Yes	3.78
HD-1500-200	200	495	295		2400	Yes	4.23
HD-1500-250	250	595	345		2500	Yes	4.80
HD-1500-300	300	695	395	2500	Yes	5.38	

<sup>(1)</sup> other strokes under request

<sup>(2)</sup> alternative forces upon request

<sup>(3)</sup> ESK available for other strokes



Pressure medium	N <sub>2</sub>	Working temperature	0-80°C	Min. security stroke	10%
Max. Charging pressure	150 bar	Temperature related force increase	+0.34%/°C	Repair Kit	KIT HD-1500
Min. Charging pressure	25 bar	Max. working speed	1.6 m/s	Linkable	G1/8"

### Mounting possibilities

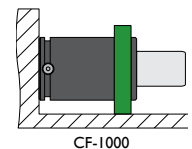
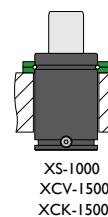
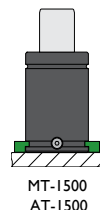
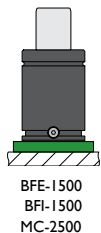
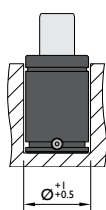
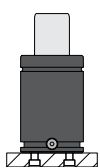

Flange must not support spring's force

## Flanges

**BFE-1500**

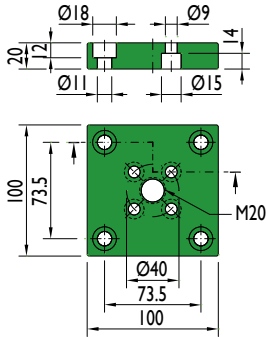

**BFI-1500**

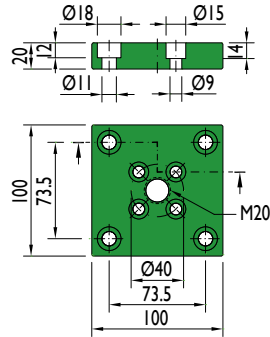

**MC-2500**

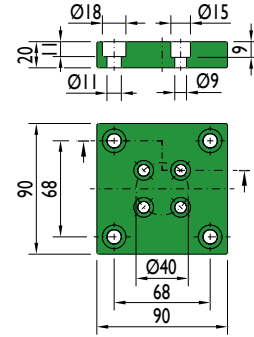

**MT-1500**

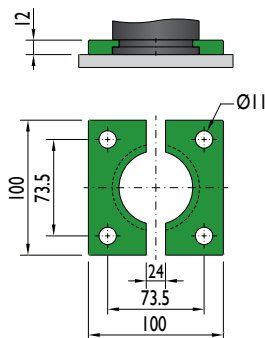

**AT-1500**

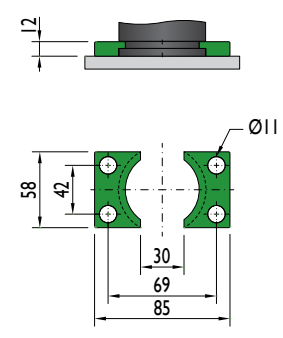

**XS-1000**

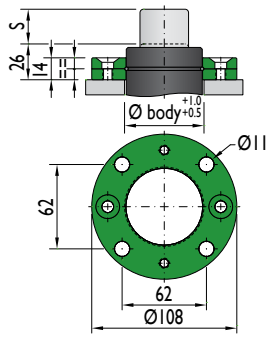

**XCV-1500**

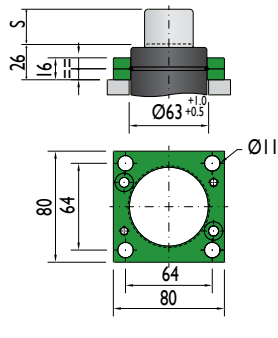

**XCK-1500**

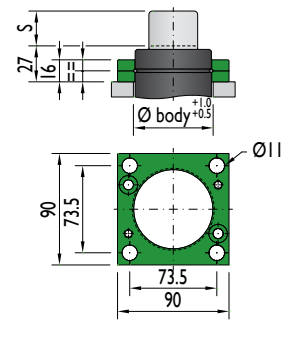

**CF-1000**

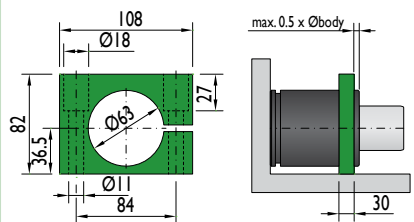

Flange must not support spring's force



CNOMO  
EM24.54.700

PSA  
E24.54.815.G

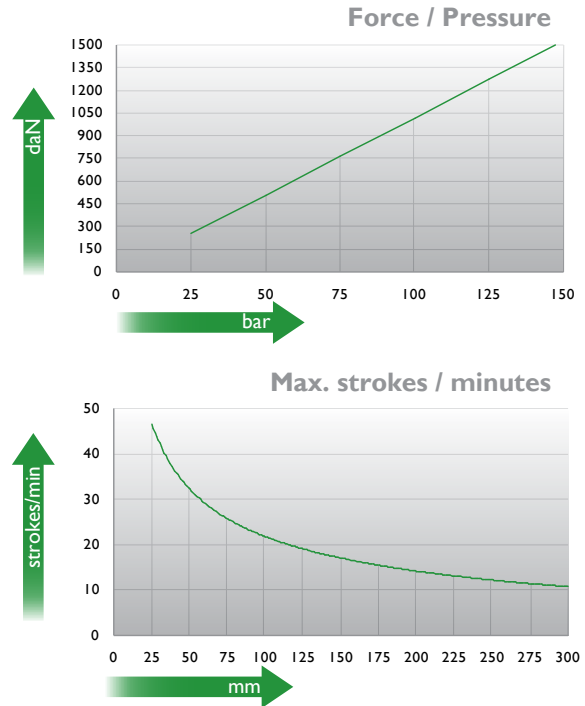
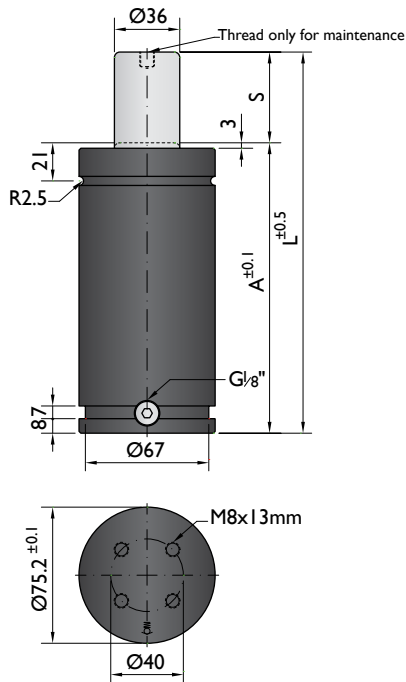

Ordering example: 4 x G-1500-125

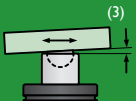
Order No.	S <sup>(1)</sup> mm	L mm	A mm	F <sub>0</sub> <sup>(2)</sup> daN (20°C, 150 bar)	F daN	 <sup>(3)</sup>	kg
G-1500-25	25	160	135	1500	1800	No	3.48
G-1500-38	38.1	186.2	148.1		1900	No	3.71
G-1500-50	50	210	160		2000	No	4.05
G-1500-63	63.5	237	173.5		2000	No	4.28
G-1500-80	80	270	190		2000	No	4.37
G-1500-100	100	310	210		2000	Yes	4.44
G-1500-125	125	360	235		2100	Yes	4.87
G-1500-160	160	430	270		2100	Yes	5.29
G-1500-200	200	510	310		2100	Yes	6.75
G-1500-250	250	610	360		2100	Yes	7.62
G-1500-300	300	710	410	2100	Yes	8.48	

<sup>(1)</sup> other strokes under request

<sup>(2)</sup> alternative forces upon request

<sup>(3)</sup> ESK available for other strokes



Pressure medium	N <sub>2</sub>	Working temperature	0-80°C	Min. security stroke	10%
Max. Charging pressure	150 bar	Temperature related force increase	+0.34%/°C	Repair Kit	KIT G-1500
Min. Charging pressure	25 bar	Max. working speed	1.6 m/s	Linkable	G1/8"

## Mounting possibilities

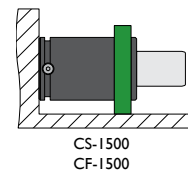
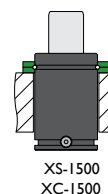
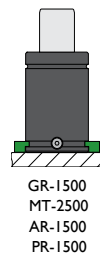
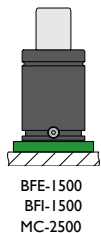
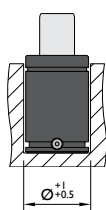
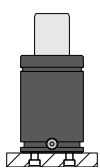

Flange must not support spring's force

## Flanges

**BFE-1500**

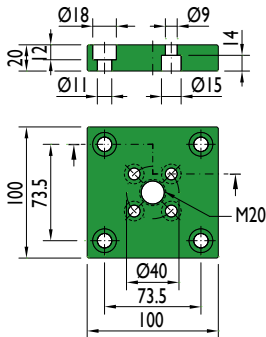

**BFI-1500**

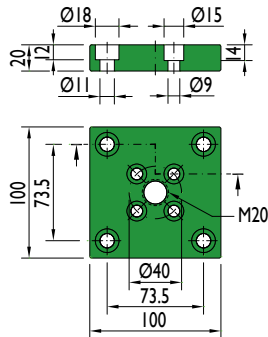

**MC-2500**

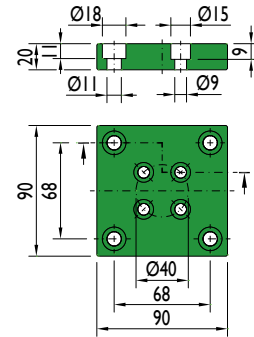

**GR-1500**

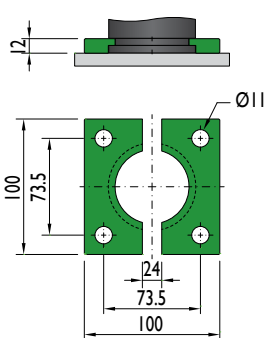

**MT-2500**

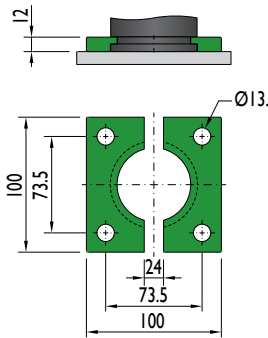

**AR-1500**

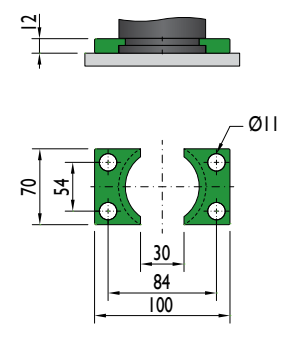

**XS-1500**

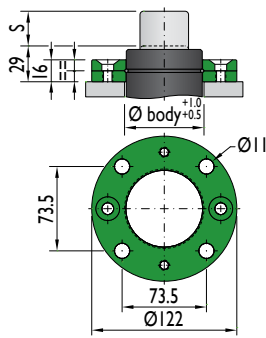

**XC-1500**

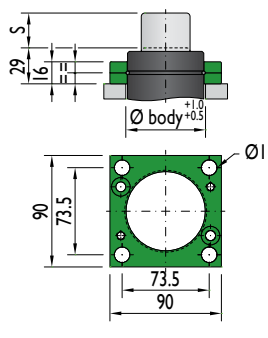

**PR-1500**

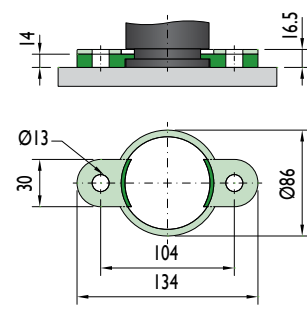

**CS-1500**

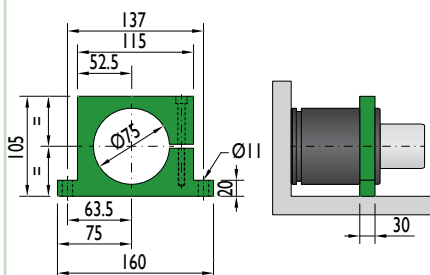

Flange must not support spring's force

**CF-1500**

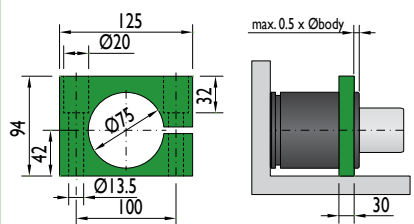

Flange must not support spring's force

Special mounts available on  
[www.nitrogas.com](http://www.nitrogas.com)

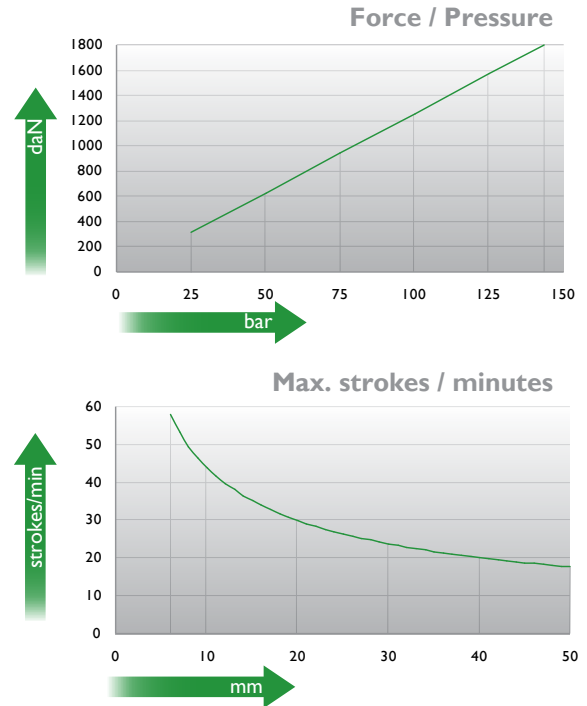
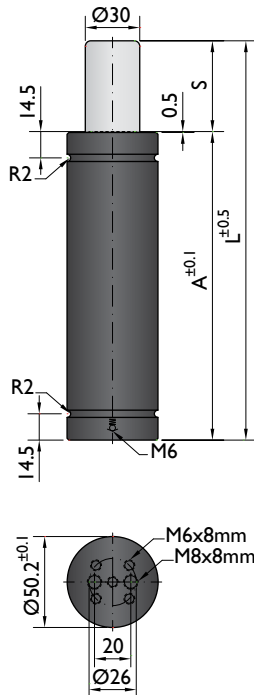

Ordering example: 4 x T-1800-50

Order No.	S <sup>(1)</sup> mm	L mm	A mm	F <sub>0</sub> <sup>(2)</sup> daN	F daN		kg
T-1800-6	6	66	60	1800 (20°C, 145 bar)	2400	No	0.63
T-1800-10	10	80	70		2700	No	0.74
T-1800-16	16	106	90		2700	No	0.89
T-1800-25	25	135	110		2700	No	1.00
T-1800-32	32	162	130		2700	No	1.15
T-1800-40	40	190	150		2700	No	1.31
T-1800-50	50	220	170		2700	No	1.48

other strokes <sup>(1)</sup> under request

alternative forces <sup>(2)</sup> upon request

ESK <sup>(3)</sup> under request



Pressure medium	N <sub>2</sub>	Working temperature	0-80°C	Min. security stroke	10%
Max. Charging pressure	145 bar	Temperature related force increase	+0.34%/°C	Repair Kit	KIT T-1800
Min. Charging pressure	25 bar	Max. working speed	0.5 m/s	Linkable	No

### Mounting possibilities

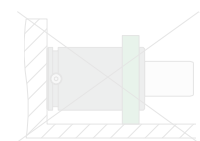
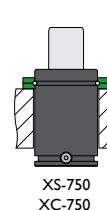
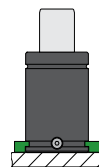
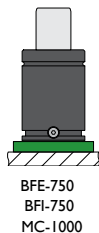
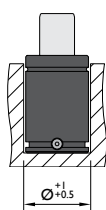
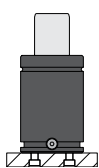

## Flanges

**BFE-750**

Technical drawing of the BFE-750 flange. The side view shows a green flange with a central bore of Ø9 and two outer bores of Ø15. The top view shows a square flange with a side length of 75 mm and a central bore diameter of 56.5 mm. It features four M10 mounting holes. Dimensions include 20 mm between bores, 12 mm bore depth, and 14 mm flange thickness.

**BFI-750**

Technical drawing of the BFI-750 flange. The side view shows a green flange with two bores of Ø15. The top view shows a square flange with a side length of 75 mm and a central bore diameter of 56.5 mm. It features four M10 mounting holes. Dimensions include 20 mm between bores, 12 mm bore depth, and 14 mm flange thickness.

**MC-1000**

Technical drawing of the MC-1000 flange. The side view shows a green flange with two bores of Ø15. The top view shows a square flange with a side length of 70 mm and a central bore diameter of 50 mm. It features four mounting holes. Dimensions include 16 mm bore depth, 9 mm bore diameter, and 9 mm flange thickness.

**XT-1800**

Technical drawing of the XT-1800 flange. The side view shows a green flange with a height of 19.5 mm. The top view shows a square flange with a side length of 70 mm and a central bore diameter of 56.5 mm. It features four Ø9 mounting holes.



**XS-750**

Technical drawing of the XS-750 flange. The side view shows a green flange with a height of 21 mm and a central bore diameter of Ø body +0.10. The top view shows a circular flange with an outer diameter of Ø95 and an inner diameter of 56.5 mm. It features four Ø9 mounting holes. Dimensions include 13 mm bore depth and S mm flange thickness.

**XC-750**

Technical drawing of the XC-750 flange. The side view shows a green flange with a height of 21 mm and a central bore diameter of Ø body +0.10. The top view shows a square flange with a side length of 70 mm and a central bore diameter of 56.5 mm. It features four Ø9 mounting holes. Dimensions include 13 mm bore depth and S mm flange thickness.

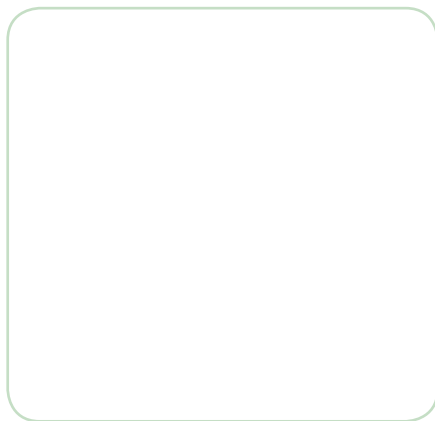
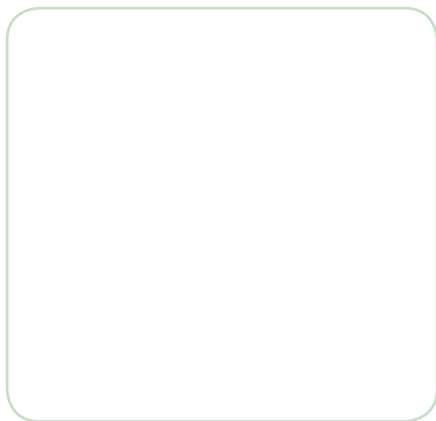



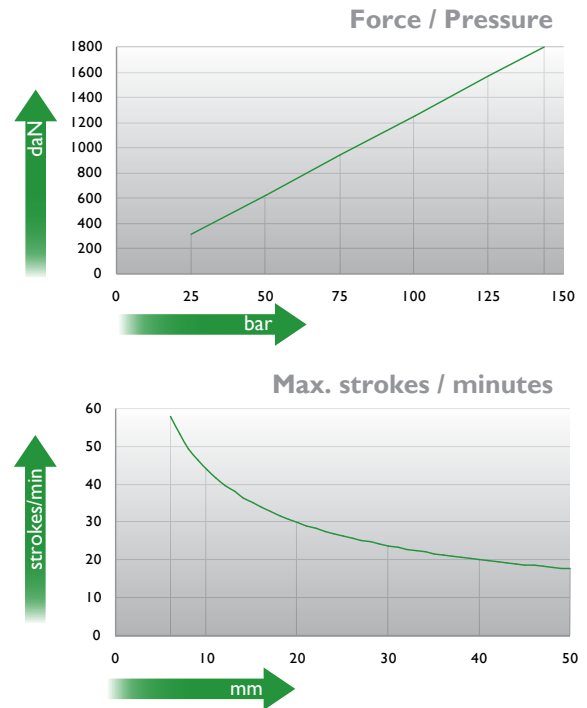
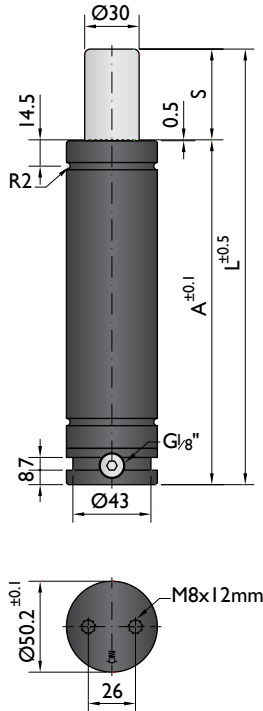

Ordering example: 4 x TC-1800-50

Order No.	S <sup>(1)</sup> mm	L mm	A mm	F <sub>0</sub> <sup>(2)</sup> daN (20°C, 145 bar)	F daN		kg
TC-1800-6	6	86	80	1800	2400	No	0.87
TC-1800-10	10	100	90		2700	No	0.98
TC-1800-16	16	126	110		2700	No	1.13
TC-1800-25	25	155	130		2700	No	1.24
TC-1800-32	32	182	150		2700	No	1.39
TC-1800-40	40	210	170		2700	No	1.55
TC-1800-50	50	240	190		2700	No	1.72

other strokes <sup>(1)</sup> under request

alternative forces <sup>(2)</sup> upon request

ESK <sup>(3)</sup> under request



Pressure medium	N <sub>2</sub>	Working temperature	0-80°C	Min. security stroke	10%
Max. Charging pressure	145 bar	Temperature related force increase	+0.34%/°C	Repair Kit	KIT TC-1800
Min. Charging pressure	25 bar	Max. working speed	0.5 m/s	Linkable	G1/8"

### Mounting possibilities

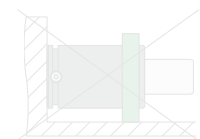
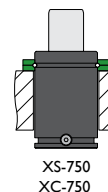
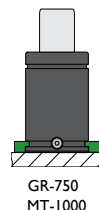
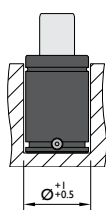
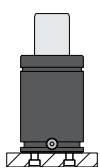

## Flanges

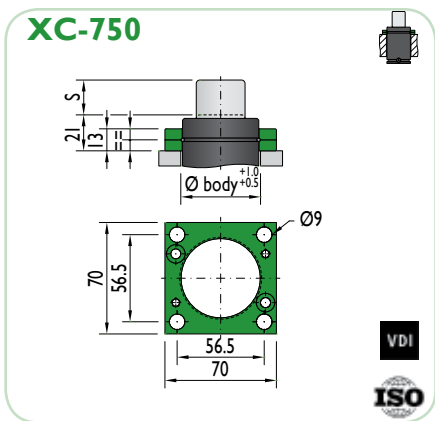
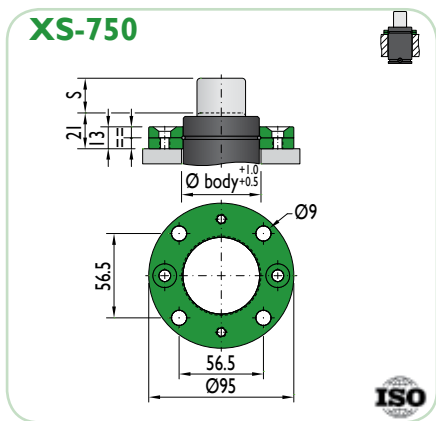
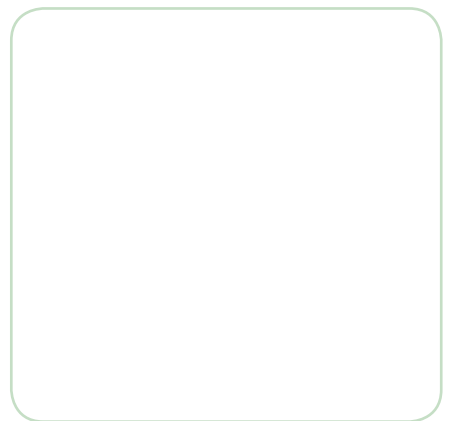
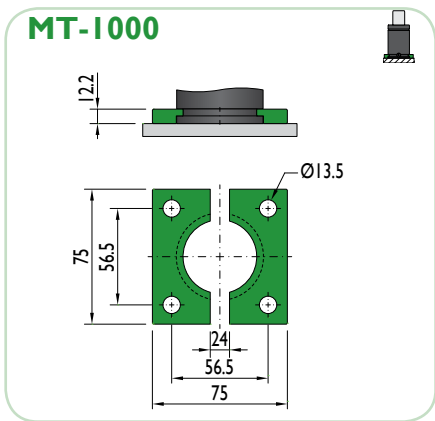
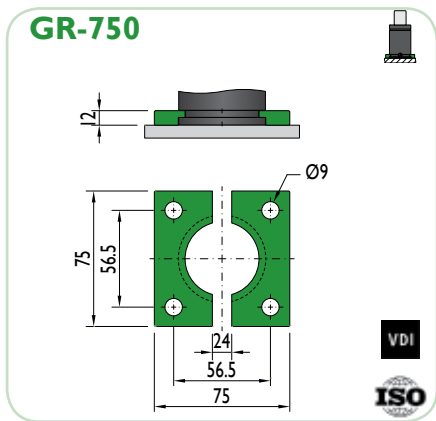

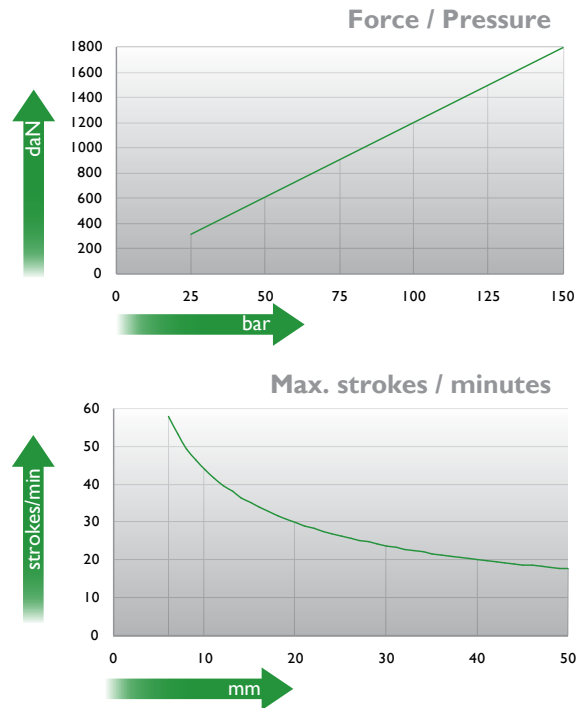
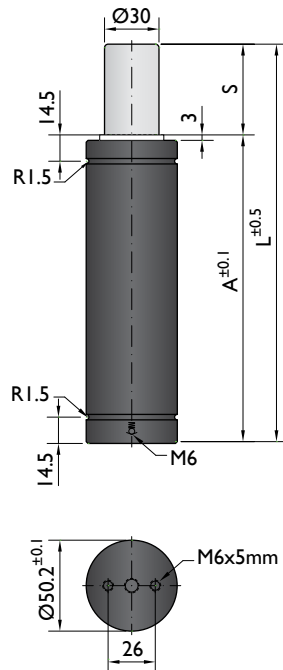

Ordering example: 4 x TS-1800-65

Order No.	S <sup>(1)</sup> mm	L mm	A mm	F <sub>0</sub> <sup>(2)</sup> daN (20°C, 150 bar)	F daN	<sup>(3)</sup>	kg
TS-1800-6	6	66	60	1800	2400	No	0.63
TS-1800-10	10	80	70		2700	No	0.74
TS-1800-16	16	106	90		2700	No	0.89
TS-1800-25	25	135	110		2700	No	1.00
TS-1800-32	32	162	130		2700	No	1.15
TS-1800-40	40	190	150		2700	No	1.31
TS-1800-50	50	220	170		2700	No	1.48
TS-1800-65	65	271	206		2700	No	1.58

other strokes <sup>(1)</sup> under request

alternative forces <sup>(2)</sup> upon request

ESK <sup>(3)</sup> under request



Pressure medium	N <sub>2</sub>	Working temperature	0-80°C	Min. security stroke	10%
Max. Charging pressure	150 bar	Temperature related force increase	+0.34%/°C	Repair Kit	KIT TS-1800
Min. Charging pressure	25 bar	Max. working speed	0.5 m/s	Linkable	No

### Mounting possibilities

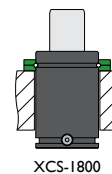
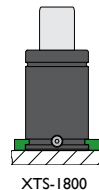
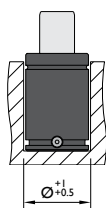
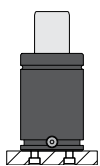

## Flanges



**XTS-1800**

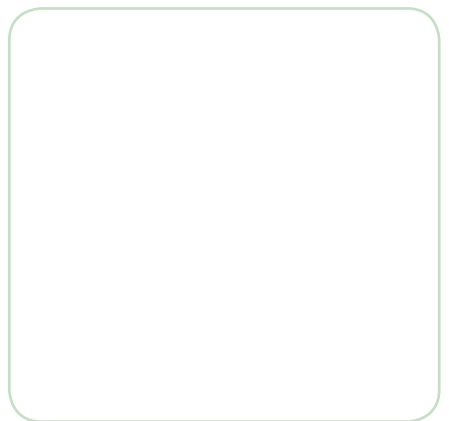
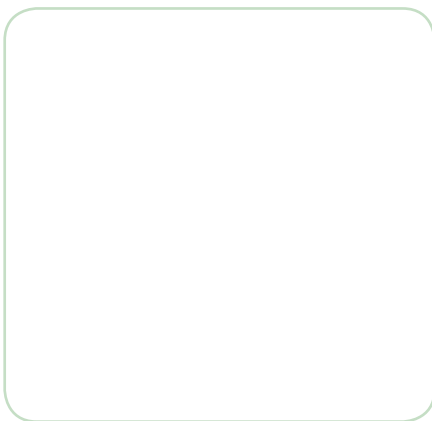

**XCS-1800**



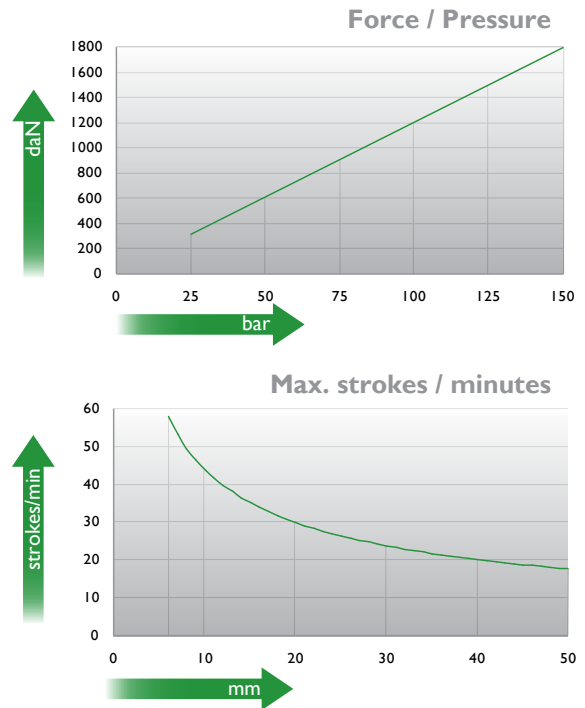
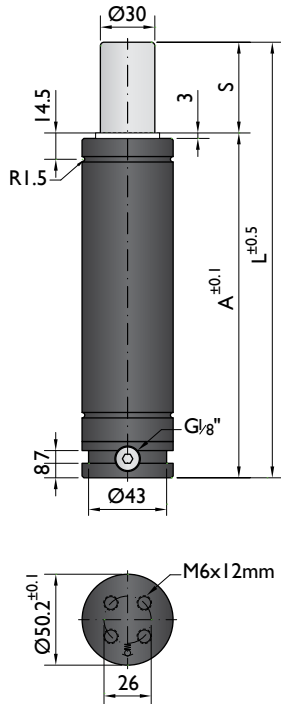

Ordering example: 4 x TSC-1800-65

Order No.	S <sup>(1)</sup> mm	L mm	A mm	F <sub>0</sub> <sup>(2)</sup> daN (20°C, 150 bar)	F daN	 <sup>(3)</sup>	kg
TSC-1800-6	6	86	80	1800	2400	No	0.87
TSC-1800-10	10	100	90		2700	No	0.98
TSC-1800-16	16	126	110		2700	No	1.13
TSC-1800-25	25	155	130		2700	No	1.24
TSC-1800-32	32	182	150		2700	No	1.39
TSC-1800-40	40	210	170		2700	No	1.55
TSC-1800-50	50	240	190		2700	No	1.72
TSC-1800-65	65	291	226		2700	No	1.89

other strokes <sup>(1)</sup> under request

alternative forces <sup>(2)</sup> upon request

ESK <sup>(3)</sup> under request



Pressure medium	N <sub>2</sub>	Working temperature	0-80°C	Min. security stroke	10%
Max. Charging pressure	150 bar	Temperature related force increase	+0.34%/°C	Repair Kit	KIT TSC-1800
Min. Charging pressure	25 bar	Max. working speed	0.5 m/s	Linkable	G1/8"

### Mounting possibilities

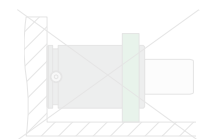
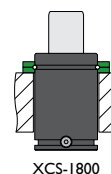
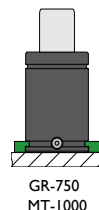
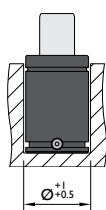
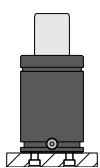

## Flanges

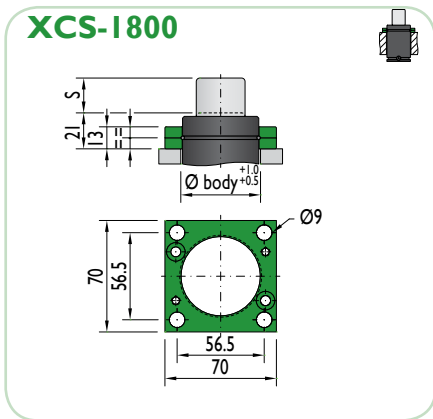
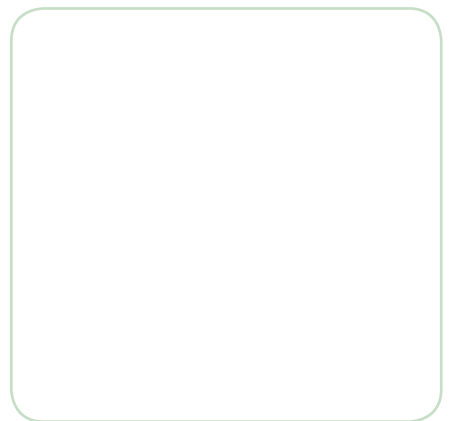
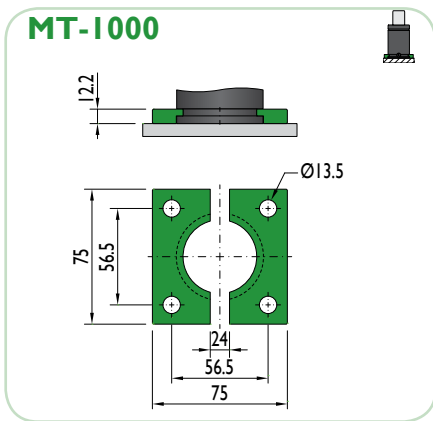
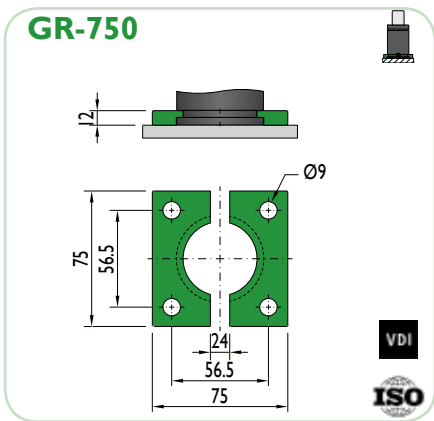

## Force 2500 daN

### Piston Rod Sealed gas springs

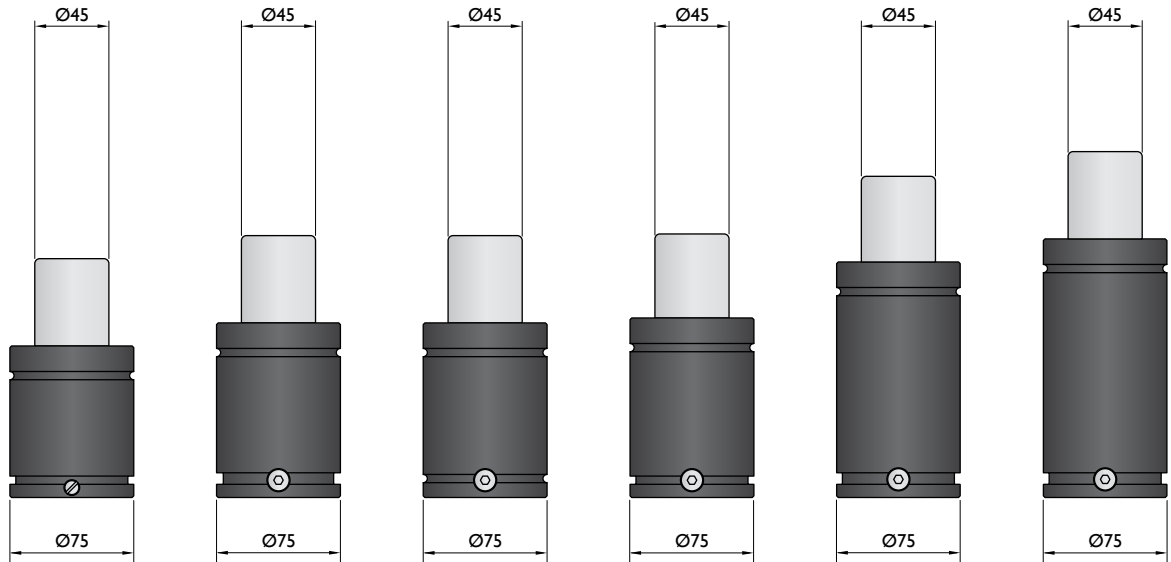
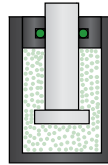

Model	KP-2400	NR-2400	NT-2400	K-2500	M-2500	HD-2400
Initial F (daN)	2400	2400	2400	2500	2500	2400
L max (mm)	2xStroke+45	2xStroke+59	2xStroke+59	2xStroke+60	2xStroke+95	2xStroke+110
Stroke (mm)	16-125	16-125	16-125	12-125	25-160	25-300

\* other strokes under request

### Standards

PED 97/23/EC	PED 97/23/EC	PED 97/23/EC	PED 97/23/EC	PED 97/23/EC	PED 97/23/EC
ISO 11901	ISO 11901	ISO 11901	ISO 11901	ISO 11901	ISO 11901
VDI 3003	VDI 3003	VDI 3003	VDI 3003	VDI 3003	VDI 3003
CNOMO EM24.54.700	CNOMO EM24.54.700	CNOMO EM24.54.700	CNOMO EM24.54.700	CNOMO EM24.54.700	CNOMO EM24.54.700







PSA  
E24.54.815.G

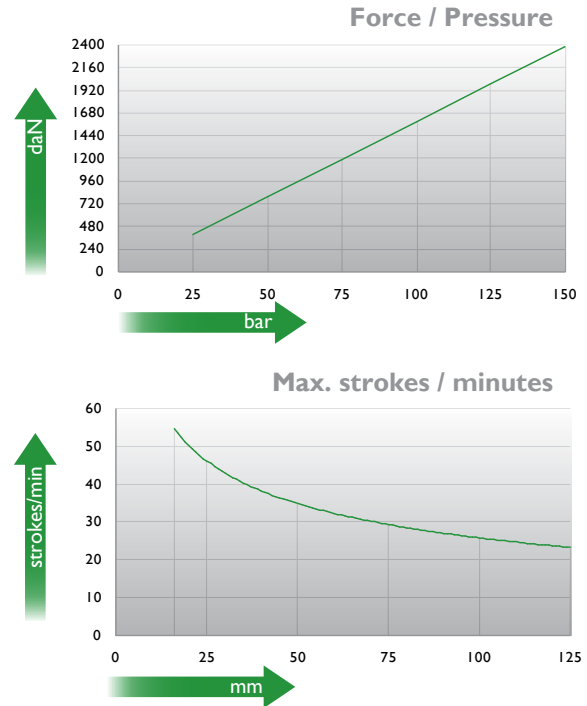
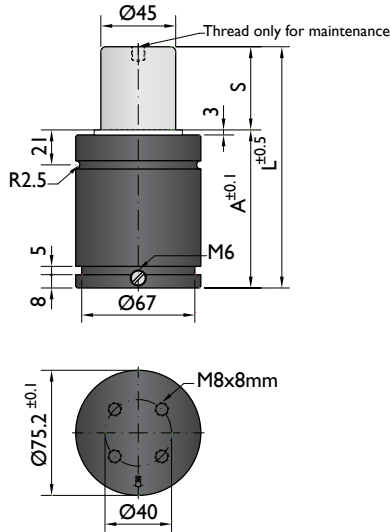

Ordering example: 4 x KP-2400-50

Order No.	S <sup>(1)</sup> mm	L mm	A mm	F <sub>0</sub> <sup>(2)</sup> daN (20°C, 150 bar)	F daN	 <sup>(3)</sup>	kg
KP-2400-16	16	77	61	2400	3700	No	1.54
KP-2400-19	19	83	64		3800	No	1.57
KP-2400-25	25	95	70		3900	No	1.59
KP-2400-32	32	109	77		4000	No	1.87
KP-2400-38	38	121	83		4000	No	1.94
KP-2400-50	50	145	95		4300	Yes	2.25
KP-2400-63	63	171	108		4300	Yes	2.52
KP-2400-75	75	195	120		4100	Yes	2.68
KP-2400-80	80	205	125		4100	Yes	2.75
KP-2400-100	100	245	145		4100	Yes	3.06
KP-2400-125	125	295	170	4100	Yes	3.31	

<sup>(1)</sup> other strokes under request

<sup>(2)</sup> alternative forces upon request

<sup>(3)</sup> ESK available for other strokes



Pressure medium	N <sub>2</sub>	Working temperature	0-80°C	Min. security stroke	10%
Max. Charging pressure	150 bar	Temperature related force increase	+0.34%/°C	Repair Kit	KIT KP-2400
Min. Charging pressure	25 bar	Max. working speed	1.6 m/s	Linkable	M6

### Mounting possibilities

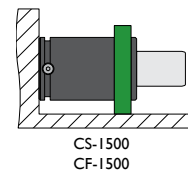
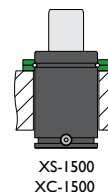
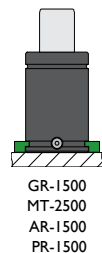
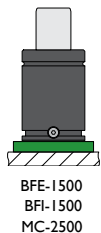
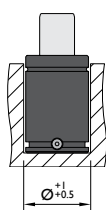
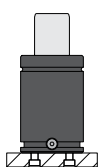

Flange must not support spring's force

## Flanges

**BFE-1500**

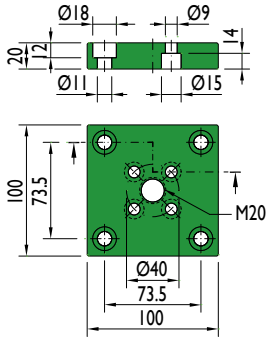

**BFI-1500**

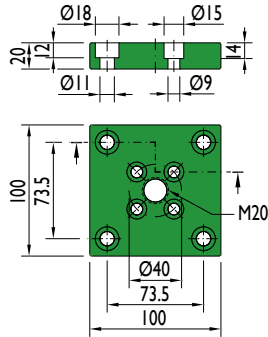

**MC-2500**

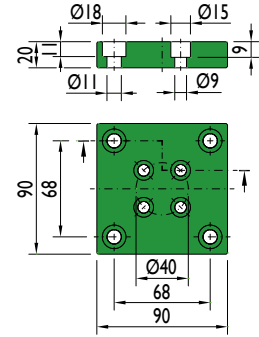

**GR-1500**

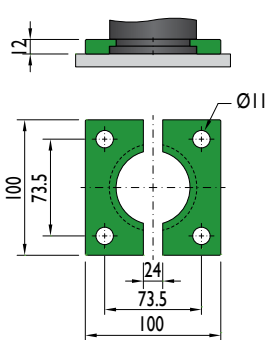

**MT-2500**

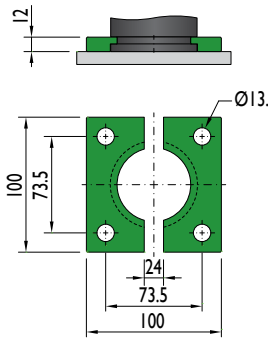

**AR-1500**

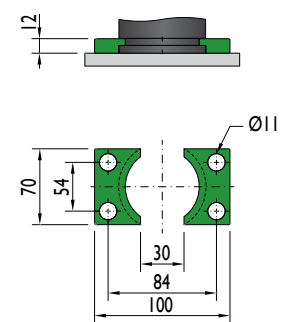

**XS-1500**

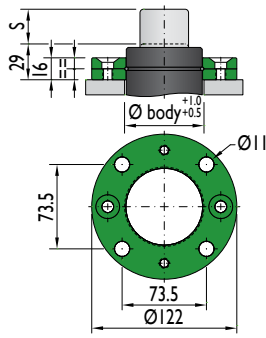

**XC-1500**

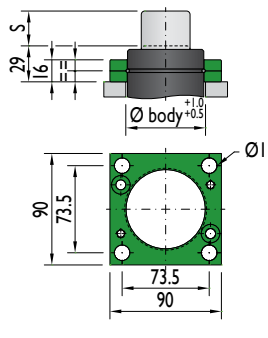

**PR-1500**

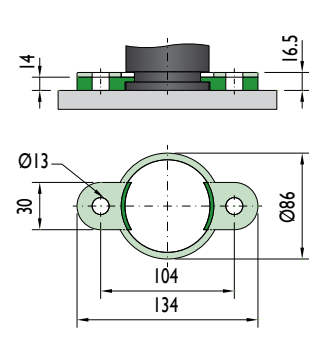

**CS-1500**

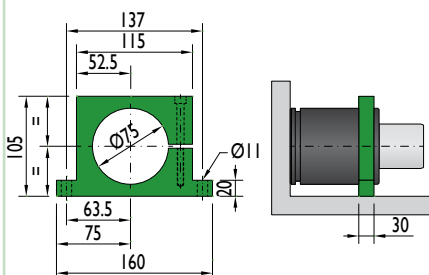

Flange must not support spring's force

**CF-1500**

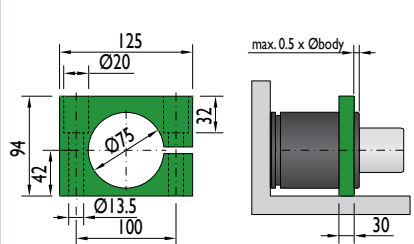

Flange must not support spring's force

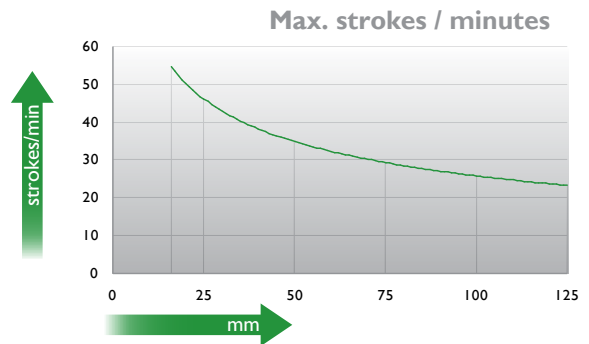
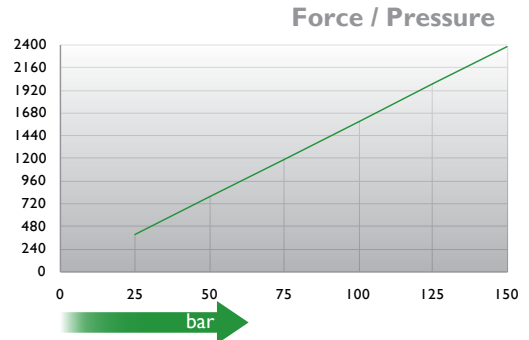
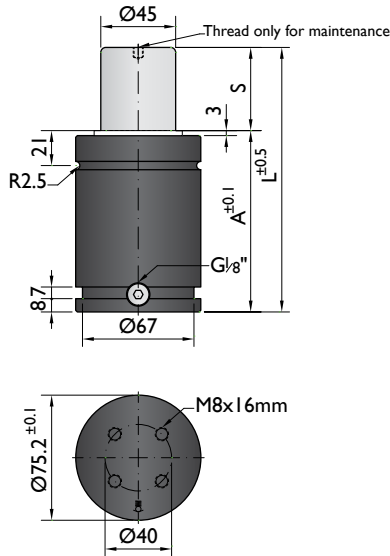

Ordering example: 4 x NR-2400-50

Order No.	S <sup>(1)</sup> mm	L mm	A mm	F <sub>0</sub> <sup>(2)</sup> daN	F daN	(3)	kg
NR-2400-16	16	91	75	2400	3700	No	2.01
NR-2400-19	19	97	78		3800	No	2.06
NR-2400-25	25	109	84		3900	No	2.17
NR-2400-32	32	123	91		4000	No	2.30
NR-2400-38	38	135	97		4000	No	2.41
NR-2400-50	50	159	109		4300	Yes	2.63
NR-2400-63	63	185	122		4300	Yes	2.86
NR-2400-75	75	209	134		4100	Yes	3.09
NR-2400-80	80	219	139		4100	Yes	3.15
NR-2400-100	100	259	159		4100	Yes	3.54
NR-2400-125	125	309	184	4100	Yes	4.05	

<sup>(1)</sup> other strokes under request

<sup>(2)</sup> alternative forces upon request

<sup>(3)</sup> ESK available for other strokes



Pressure medium	N <sub>2</sub>	Working temperature	0-80°C	Min. security stroke	10%
Max. Charging pressure	150 bar	Temperature related force increase	+0.34%/°C	Repair Kit	KIT NR-2400
Min. Charging pressure	25 bar	Max. working speed	1.6 m/s	Linkable	G1/8"

## Mounting possibilities

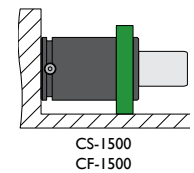
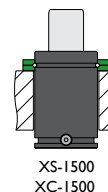
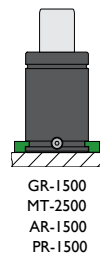
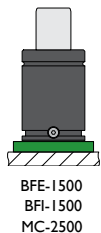
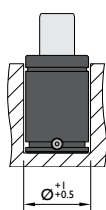
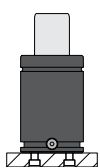

Flange must not support spring's force

## Flanges

**BFE-1500**

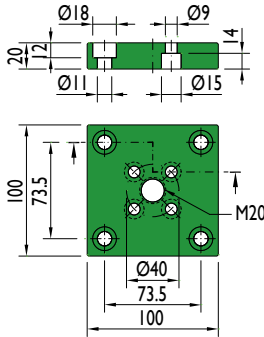

**BFI-1500**

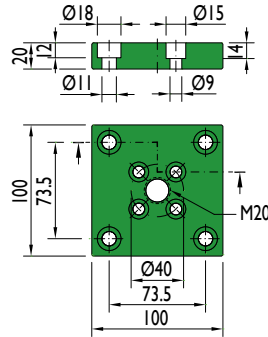

**MC-2500**

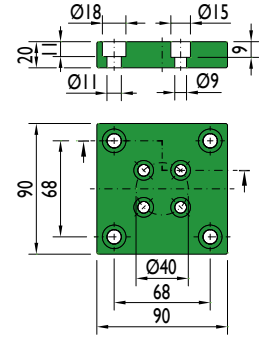

**GR-1500**

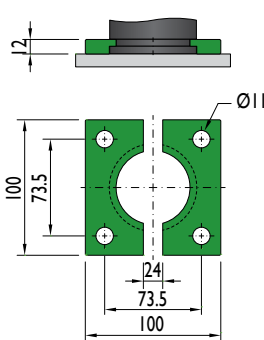

**MT-2500**

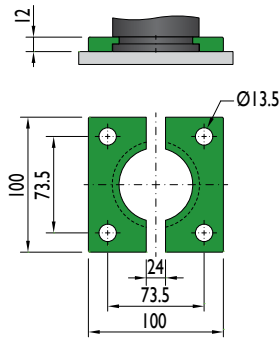

**AR-1500**

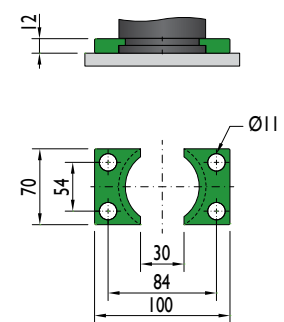

**XS-1500**

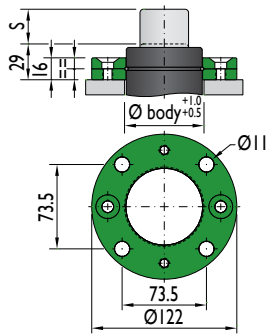

**XC-1500**

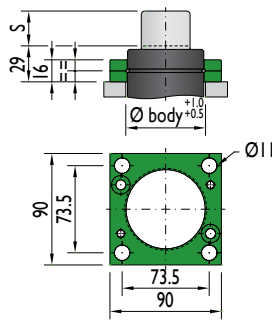

**PR-1500**

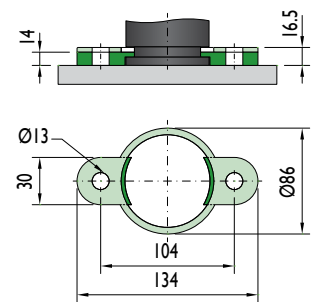

**CS-1500**

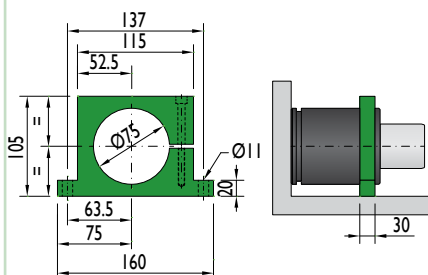

Flange must not support spring's force

**CF-1500**

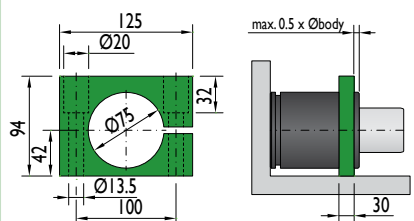

Flange must not support spring's force



PSA  
E24.54.815.G

SMS DNH  
3203N

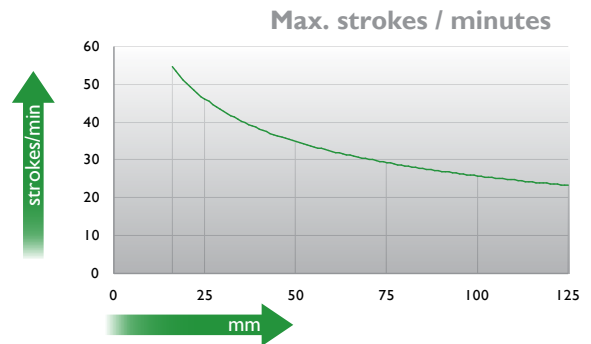
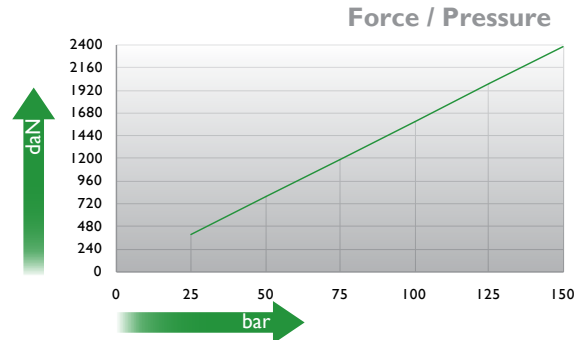
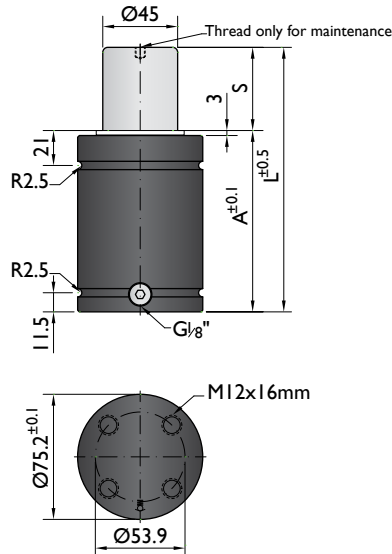

Ordering example: 4 x NT-2400-50

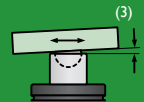
Order No.	S <sup>(1)</sup> mm	L mm	A mm	F <sub>0</sub> <sup>(2)</sup> daN (20°C, 150 bar)	F daN	 <sup>(3)</sup>	kg
NT-2400-16	16	91	75	2400	3700	No	2.01
NT-2400-19	19	97	78		3800	No	2.06
NT-2400-25	25	109	84		3900	No	2.17
NT-2400-32	32	123	91		4000	No	2.30
NT-2400-38	38	135	97		4000	No	2.41
NT-2400-50	50	159	109		4300	Yes	2.63
NT-2400-63	63	185	122		4300	Yes	2.86
NT-2400-75	75	209	134		4100	Yes	3.09
NT-2400-80	80	219	139		4100	Yes	3.15
NT-2400-100	100	259	159		4100	Yes	3.54
NT-2400-125	125	309	184		4100	Yes	4.05

<sup>(1)</sup> other strokes under request

<sup>(2)</sup> alternative forces upon request

<sup>(3)</sup> ESK available for other strokes



Pressure medium	N <sub>2</sub>	Working temperature	0-80°C	Min. security stroke	10%
Max. Charging pressure	150 bar	Temperature related force increase	+0.34%/°C	Repair Kit	KIT NT-2400
Min. Charging pressure	25 bar	Max. working speed	1.6 m/s	Linkable	G1/8"

## Mounting possibilities

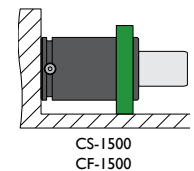
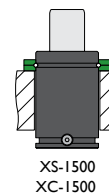
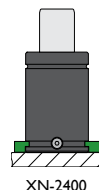
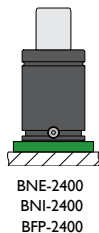
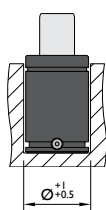
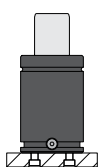

Flange must not support spring's force

## Flanges

**BNE-2400**

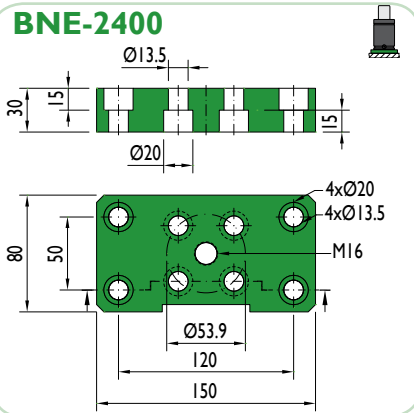

**BNI-2400**

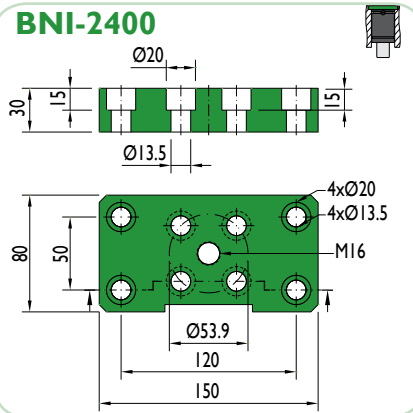

**BFP-2400**

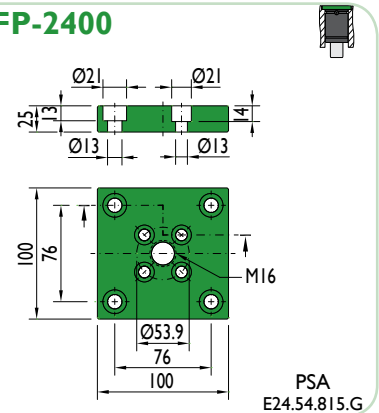

**XN-2400**

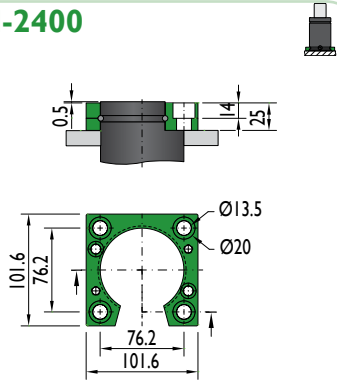

**XS-1500**

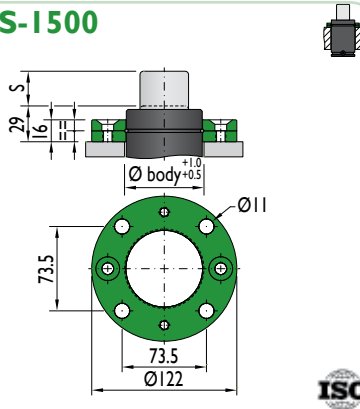

**XC-1500**

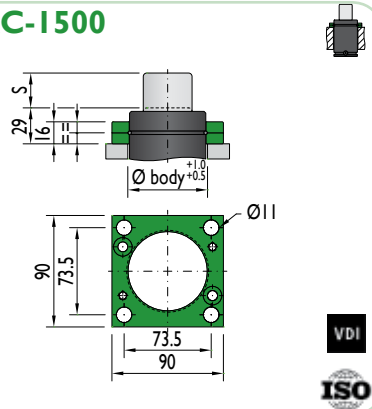

**CS-1500**

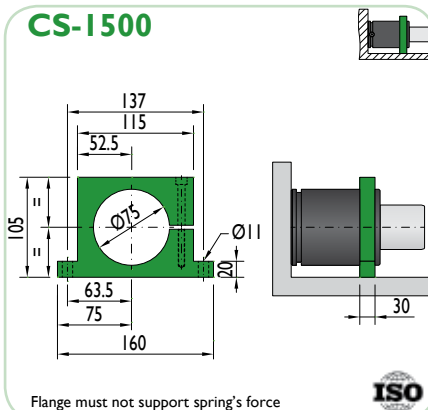

Flange must not support spring's force

**CF-1500**

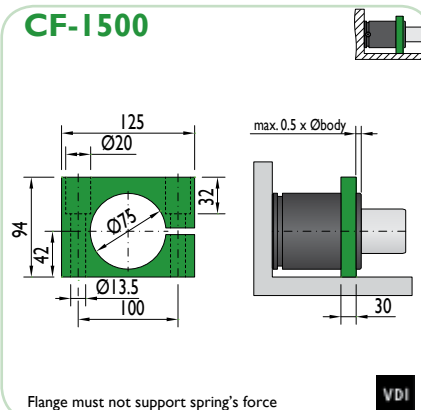

Flange must not support spring's force

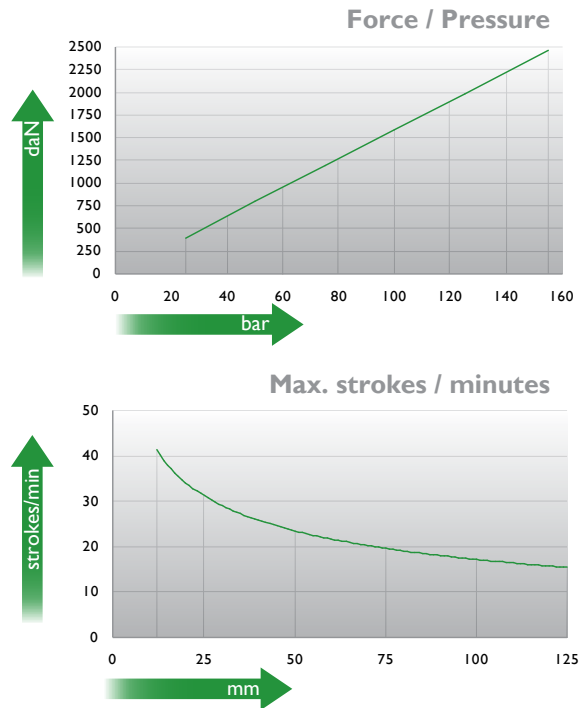
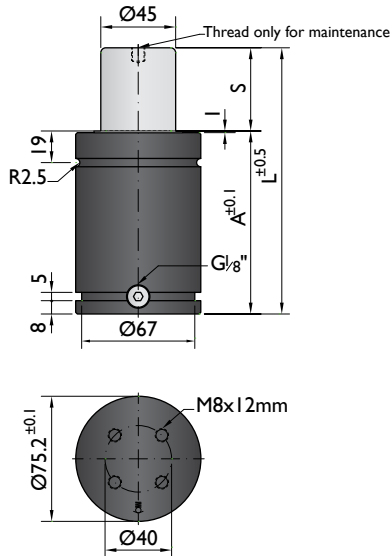

Ordering example: 4 x K-2500-50

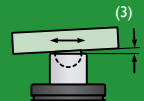
Order No.	S <sup>(1)</sup> mm	L mm	A mm	F <sub>0</sub> <sup>(2)</sup> daN (20°C, 155 bar)	F daN	 <sup>(3)</sup>	kg
K-2500-12	12	84	72	2500	3500	No	1.96
K-2500-25	25	110	85		3800	No	2.18
K-2500-38	38	136	98		4000	No	2.43
K-2500-50	50	160	110		4300	Yes	2.82
K-2500-63	63	186	123		4100	Yes	2.96
K-2500-80	80	220	140		4100	Yes	3.20
K-2500-100	100	260	160		4100	Yes	3.45
K-2500-125	125	310	185		4100	Yes	3.80

other strokes <sup>(1)</sup> under request

alternative forces <sup>(2)</sup> upon request

ESK available for other strokes <sup>(3)</sup>



Pressure medium	N <sub>2</sub>	Working temperature	0-80°C	Min. security stroke	10%
Max. Charging pressure	155 bar	Temperature related force increase	+0.34%/°C	Repair Kit	KIT K-2500
Min. Charging pressure	25 bar	Max. working speed	1.6 m/s	Linkable	G1/8"

### Mounting possibilities

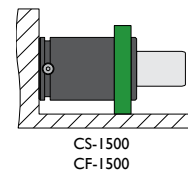
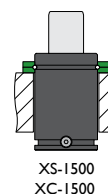
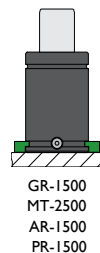
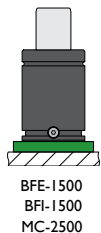
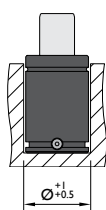
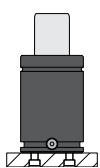

Flange must not support spring's force

## Flanges

**BFE-1500**

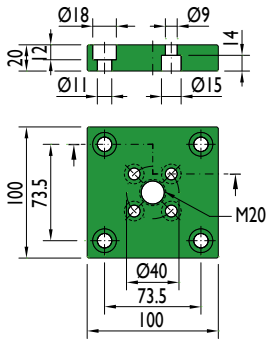

**BFI-1500**

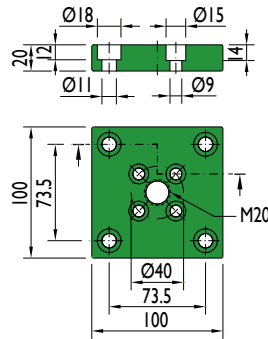

**MC-2500**

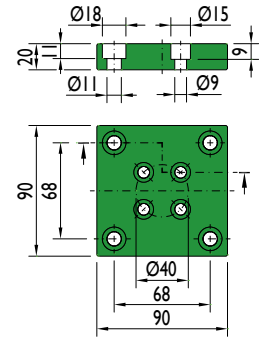

**GR-1500**

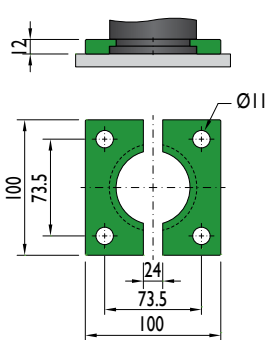

**MT-2500**

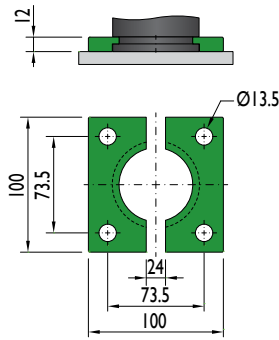

**AR-1500**

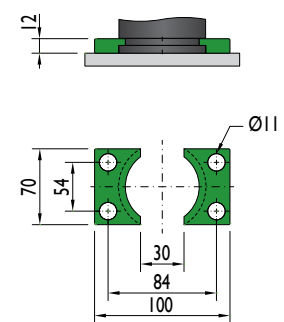

**XS-1500**

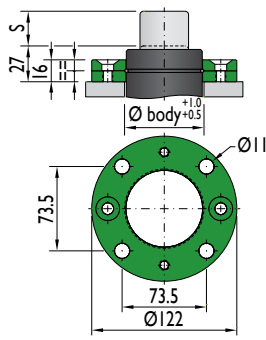

**XC-1500**

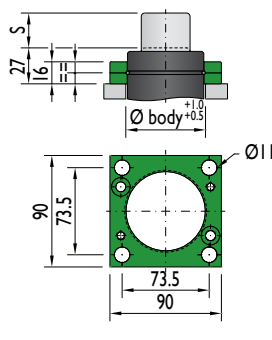

**PR-1500**

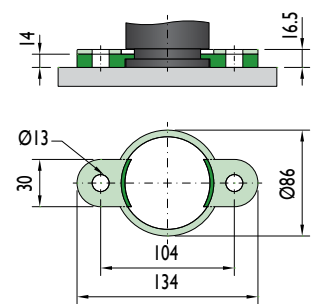

**CS-1500**

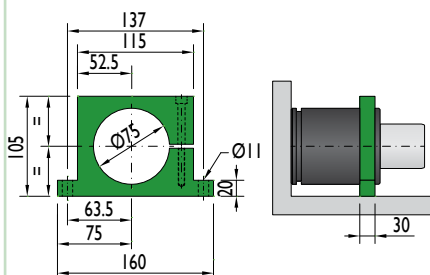

Flange must not support spring's force

**CF-1500**

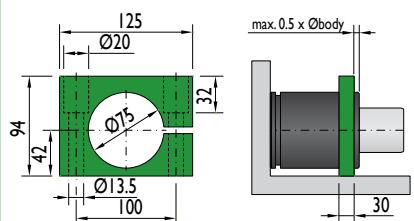

Flange must not support spring's force





\*The new cylinder will be supplied when the stock runs out.

### NEW MODEL\*

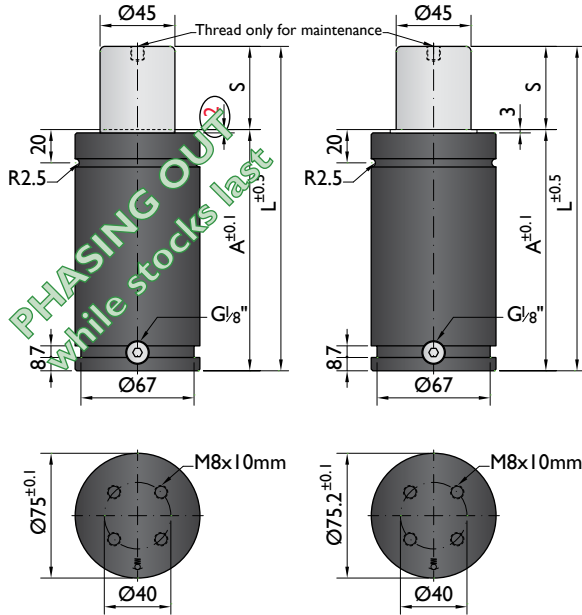

PHASING OUT  
While stocks last

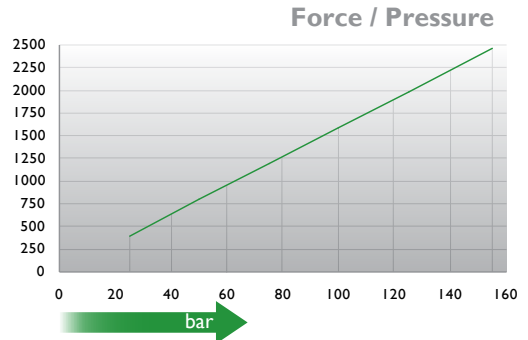

↑ daN

→ bar

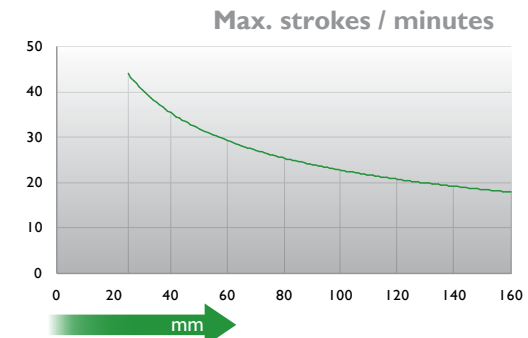

↑ strokes/min

→ mm

Ordering example: 4 x M-2500-50

Order No.	S <sup>(1)</sup> mm	L mm	A mm	F <sub>0</sub> <sup>(2)</sup> daN	F daN	<sup>(3)</sup>	kg
M-2500-25	25	145	120	2500	3300	No	2.85
M-2500-38	38	171	133		3500	No	3.21
M-2500-50	50	195	145		3600	No	3.29
M-2500-63	63	221	158		3700	No	3.50
M-2500-80	80	255	175		3900	Yes	3.85
M-2500-100	100	300	200		3900	Yes	4.30
M-2500-125	125	350	225		3900	Yes	4.74
M-2500-160	160	425	265		4000	Yes	5.34

other strokes <sup>(1)</sup> under request

alternative forces <sup>(2)</sup> upon request

ESK available for other strokes <sup>(3)</sup>



Pressure medium	N <sub>2</sub>	Working temperature	0-80°C	Min. security stroke	10%
Max. Charging pressure	155 bar	Temperature related force increase	+0.34%/°C	Repair Kit	KIT M-2500
Min. Charging pressure	25 bar	Max. working speed	1.6 m/s	Linkable	G1/8"

### Mounting possibilities

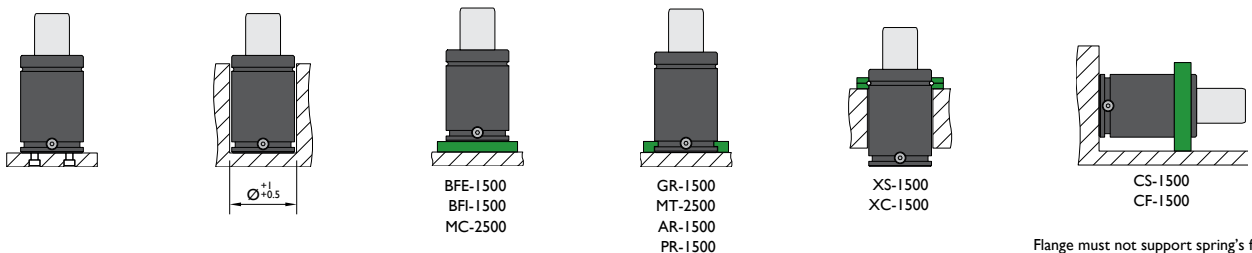

## Flanges

**BFE-1500**

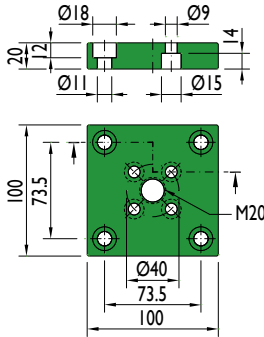

**BFI-1500**

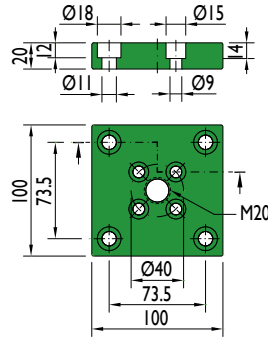

**MC-2500**

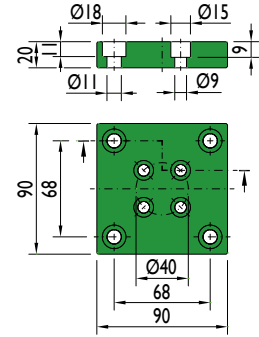

**GR-1500**

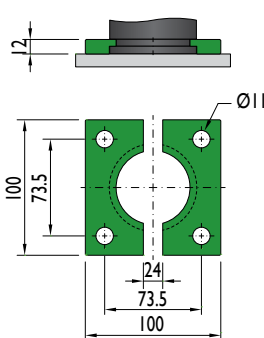

**MT-2500**

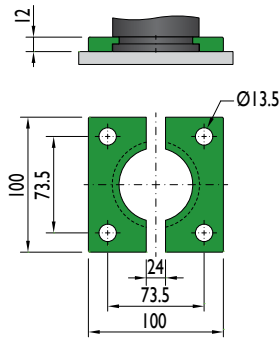

**AR-1500**

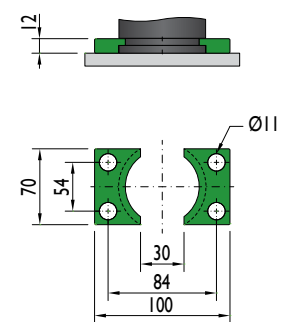

**XS-1500**

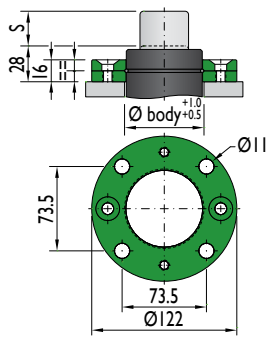

**XC-1500**

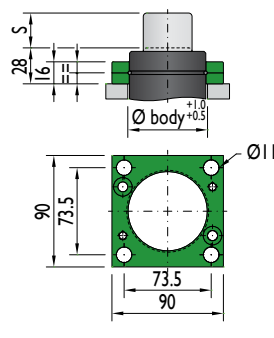

**PR-1500**

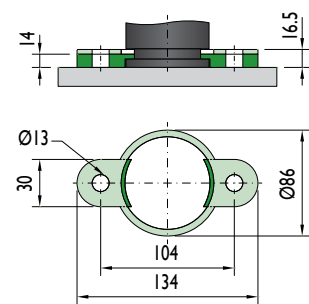

**CS-1500**

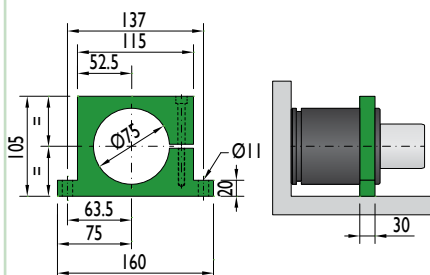

Flange must not support spring's force

**CF-1500**

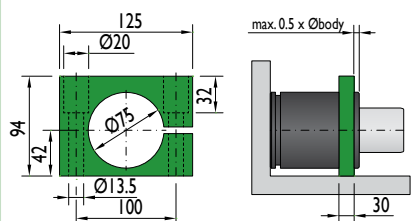

Flange must not support spring's force

Special mounts available on

[www.nitrogas.com](http://www.nitrogas.com)

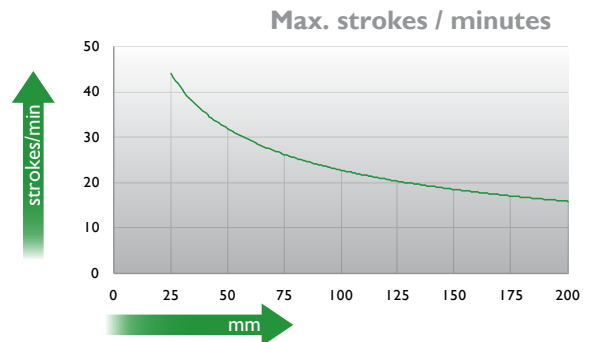
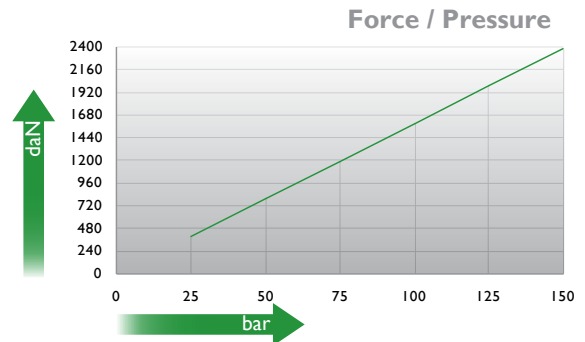
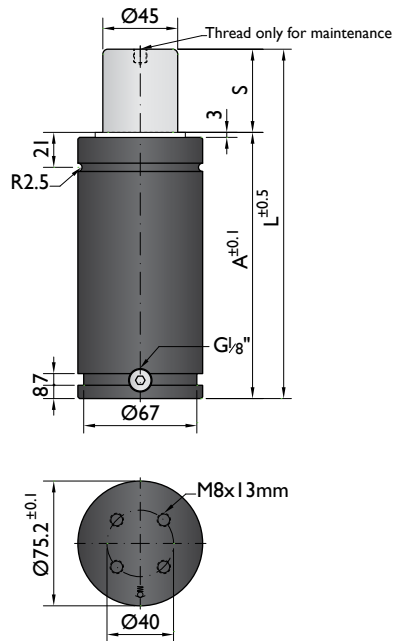

Ordering example: 4 x HD-2400-50

Order No.	S <sup>(1)</sup> mm	L mm	A mm	F <sub>0</sub> <sup>(2)</sup> daN	F daN	(3)	kg
HD-2400-25	25	160	135		3000	No	3.16
HD-2400-38	38	186	148		3200	No	3.41
HD-2400-50	50	210	160		3300	No	3.75
HD-2400-63	63	236	173		3400	No	4.00
HD-2400-80	80	270	190		3600	Yes	4.32
HD-2400-100	100	310	210	2400	3600	Yes	4.59
HD-2400-125	125	360	235		3700	Yes	5.04
HD-2400-160	160	430	270		3800	Yes	5.68
HD-2400-200	200	510	310		3900	Yes	6.42
HD-2400-250	250	610	360		3900	Yes	7.21
HD-2400-300	300	710	410		4000	Yes	8.00

<sup>(1)</sup> other strokes under request

<sup>(2)</sup> alternative forces upon request

<sup>(3)</sup> ESK available for other strokes



Pressure medium	N <sub>2</sub>	Working temperature	0-80°C	Min. security stroke	10%
Max. Charging pressure	150 bar	Temperature related force increase	+0.34%/°C	Repair Kit	KIT HD-2400
Min. Charging pressure	25 bar	Max. working speed	1.6 m/s	Linkable	G1/8"

### Mounting possibilities

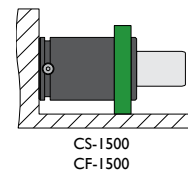
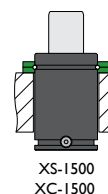
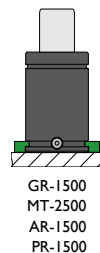
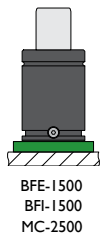
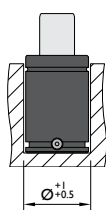
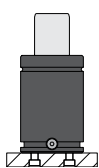

Flange must not support spring's force

## Flanges

**BFE-1500**

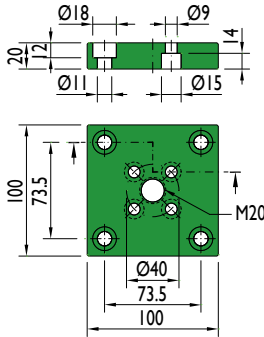

**BFI-1500**

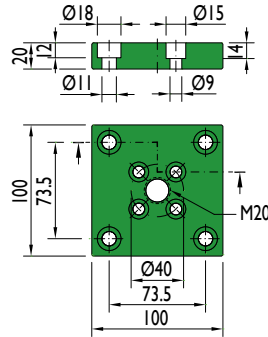

**MC-2500**

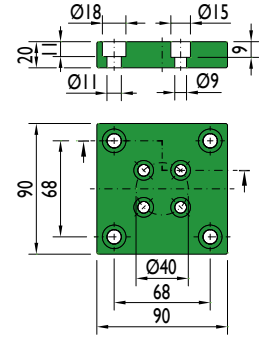

**GR-1500**

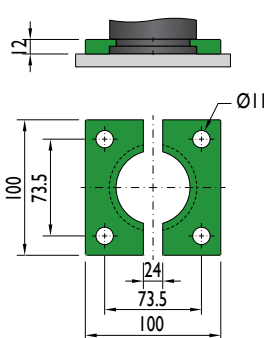

**MT-2500**

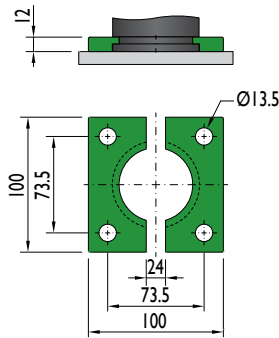

**AR-1500**

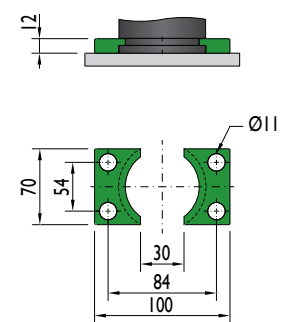

**XS-1500**

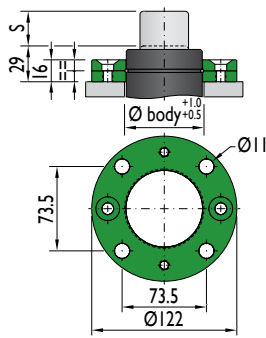

**XC-1500**

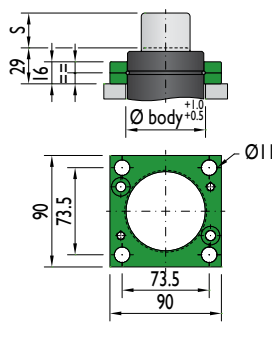

**PR-1500**

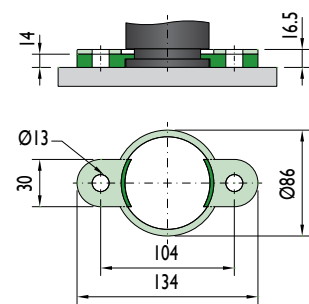

**CS-1500**

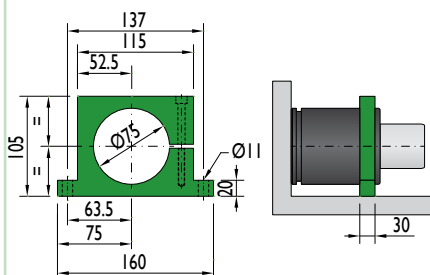

Flange must not support spring's force

**CF-1500**

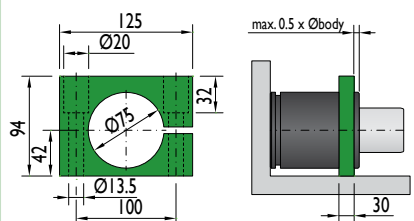

Flange must not support spring's force

## Force 3000 daN

### Piston Rod Sealed gas springs

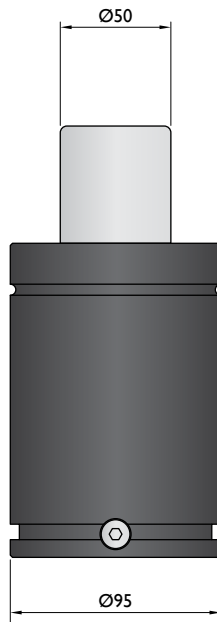
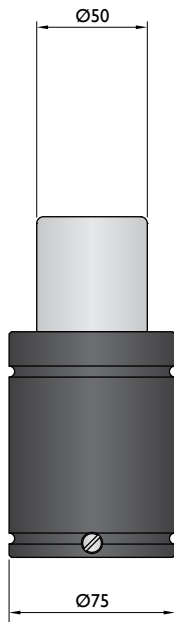
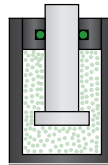

Model	KC-3000	HG-3000	G-3000
Initial F (daN)	3000	3000	3000
L max (mm)	2xStroke+54	2xStroke+95	2xStroke+120
Stroke (mm)	12-125	25-200	25-300

\* other strokes under request

### Standards

**PED**  
97/23/EC

**ISO**  
11901

**VDI**  
3003

**CNOMO**  
EM24.54.700

**PED**  
97/23/EC

**ISO**  
11901

**VDI**  
3003

**CNOMO**  
EM24.54.700

**PED**  
97/23/EC

**ISO**  
11901

**VDI**  
3003

**CNOMO**  
EM24.54.700

## Force 3000 daN

### Bore Sealed gas springs

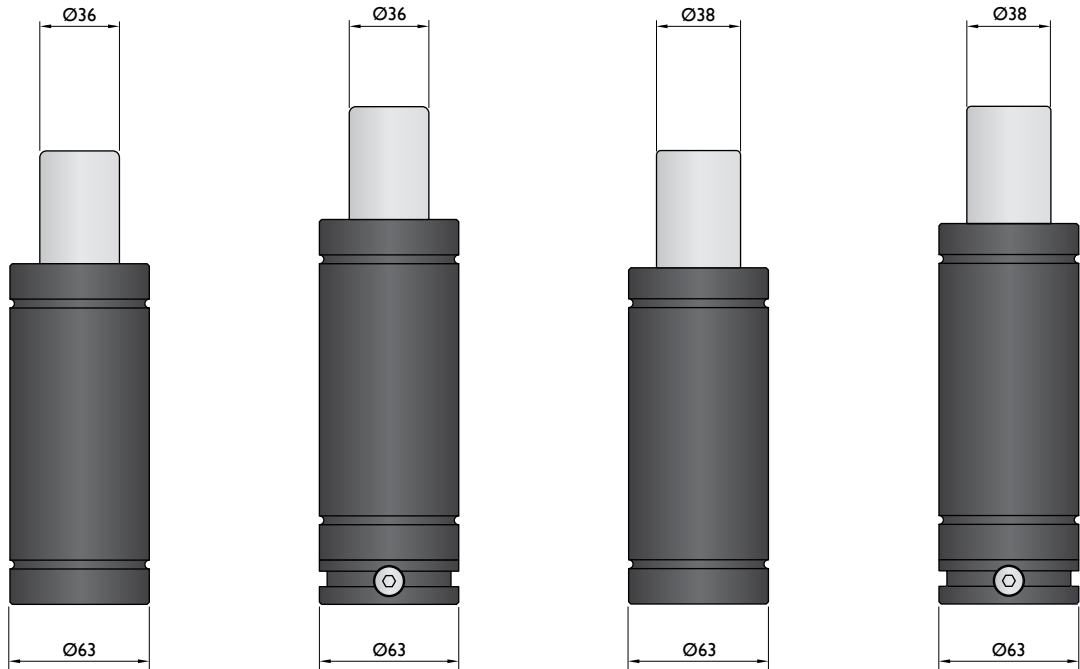
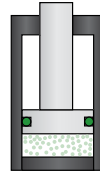

Model	T-3000	TC-3000	TS-3000	TSC-3000
Initial F (daN)	3000	3000	3000	3000
L max (mm)	85-205	105-225	85-256	105-276
Stroke (mm)	10-50	10-50	10-65	10-65

\* other strokes under request

### Standards

**PED**  
97/23/EC

ISO  
11901

VDI  
3003

CNOMO  
EM24.54.700

**PED**  
97/23/EC

ISO  
11901

VDI  
3003

CNOMO  
EM24.54.700

**PED**  
97/23/EC

ISO  
11901

VDI  
3003

CNOMO  
EM24.54.700

**PED**  
97/23/EC

ISO  
11901

VDI  
3003

CNOMO  
EM24.54.700



\*The new cylinder will be supplied when the stock runs out.

**NEW MODEL\***

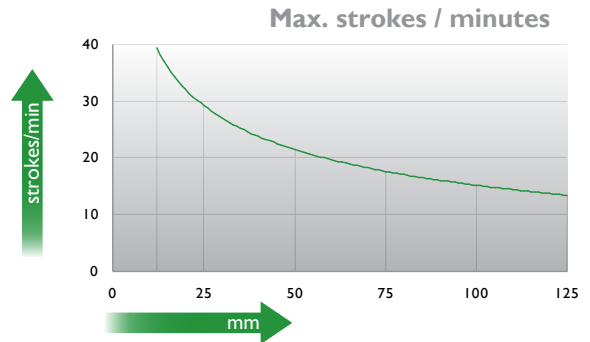
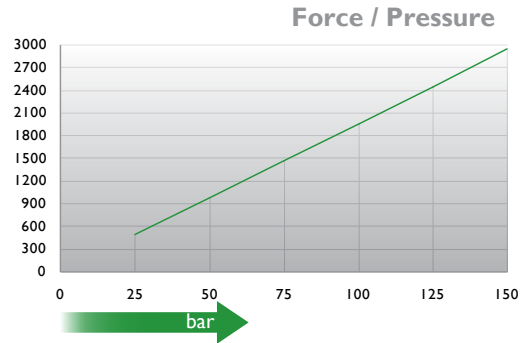
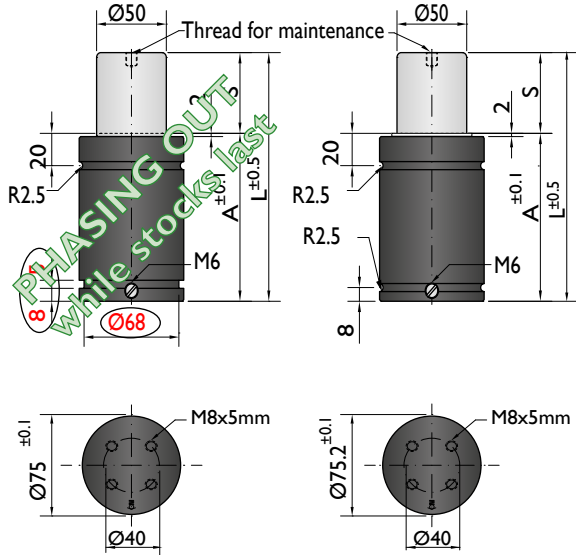

Ordering example: 4 x KC-3000-125

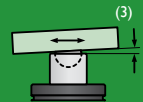
Order No.	S <sup>(1)</sup> mm	L mm	A mm	F <sub>0</sub> <sup>(2)</sup> daN (20°C, 150 bar)	F daN		kg
KC-3000-12	12	78	66	3000	4300	No	1.65
KC-3000-25	25	104	79		4800	No	1.87
KC-3000-38	38	130	92		5000	No	2.12
KC-3000-50	50	154	104		5300	Yes	2.31
KC-3000-63	63	180	117		5300	Yes	2.60
KC-3000-80	80	214	134		5300	Yes	2.93
KC-3000-100	100	254	154		5300	Yes	3.20
KC-3000-125	125	304	179		5400	Yes	3.41

other strokes <sup>(1)</sup> under request

alternative forces <sup>(2)</sup> upon request

ESK available for other strokes <sup>(3)</sup>



Pressure medium	N <sub>2</sub>	Working temperature	0-80°C	Min. security stroke	10%
Max. Charging pressure	150 bar	Temperature related force increase	+0.34%/°C	Repair Kit	KIT KC-3000
Min. Charging pressure	25 bar	Max. working speed	1.6 m/s	Linkable	M6

**Mounting possibilities**

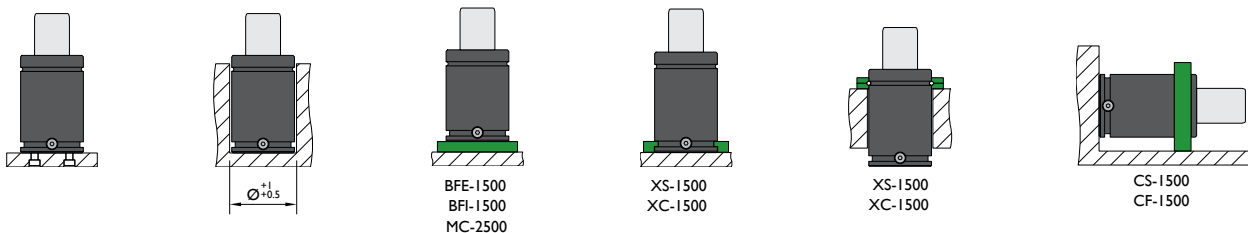

Flange must not support spring's force

## Flanges

**BFE-1500**

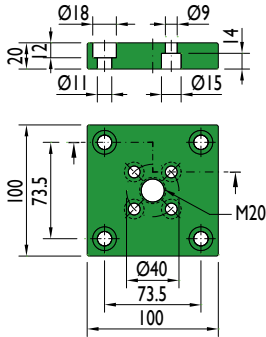

**BFI-1500**

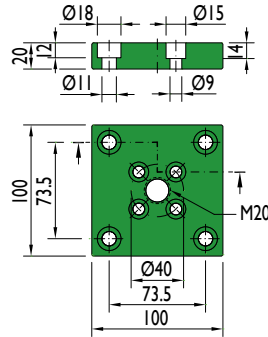

**MC-2500**

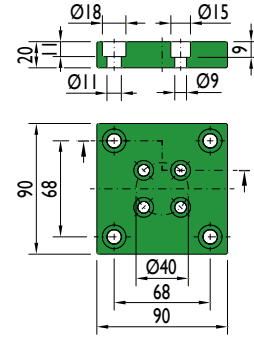

**XS-1500**

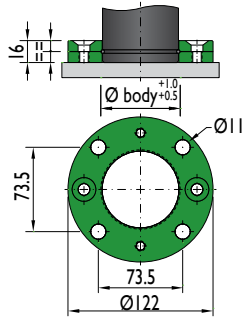

**XC-1500**

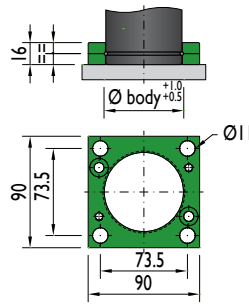

**XS-1500**

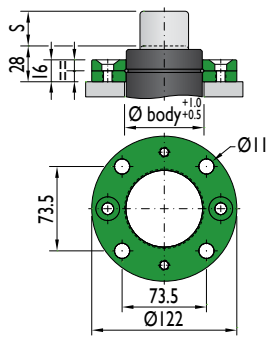

**XC-1500**

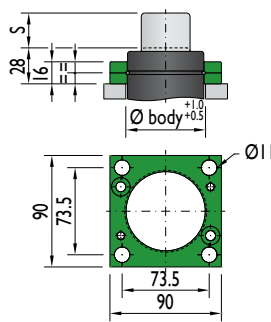

**CS-1500**

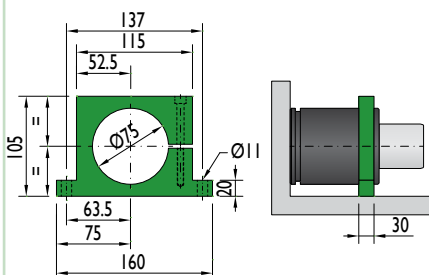

Flange must not support spring's force

**CF-1500**

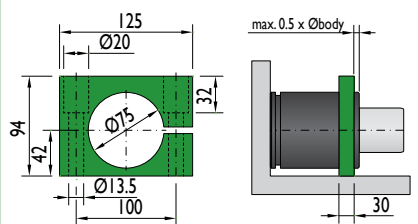

Flange must not support spring's force



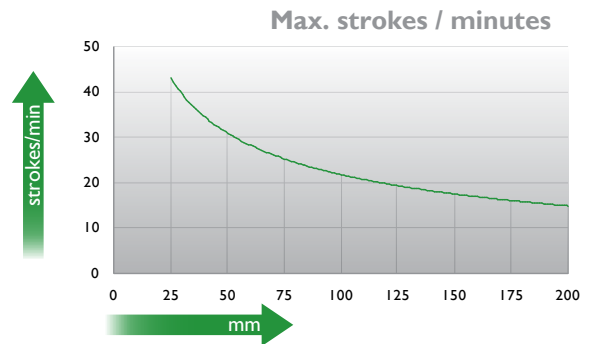
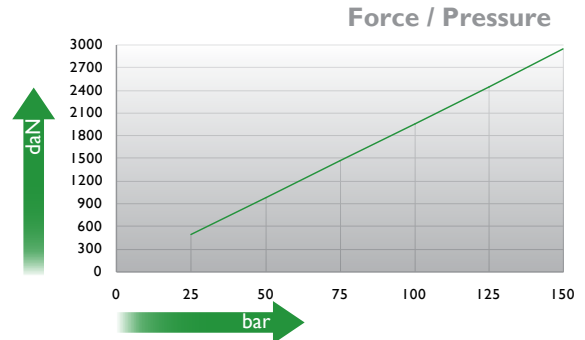
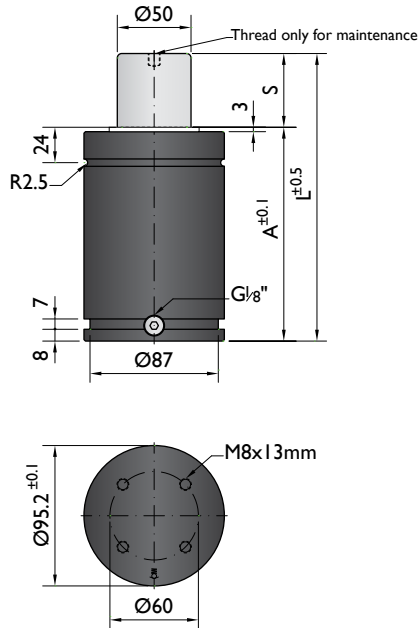

Ordering example: 4 x HG-3000-125

Order No.	S <sup>(1)</sup> mm	L mm	A mm	F <sub>0</sub> <sup>(2)</sup> daN (20°C, 150 bar)	F daN	(3)	kg
HG-3000-25	25	145	120		4100	No	4.42
HG-3000-38	37.5	170	132.5		4300	No	4.72
HG-3000-50	50	195	145		4400	No	5.03
HG-3000-63	62.5	220	157.5		4500	No	5.34
HG-3000-80	80	255	175	3000	4500	Yes	5.76
HG-3000-100	100	295	195		4600	Yes	6.25
HG-3000-125	125	345	220		4600	Yes	6.87
HG-3000-160	160	415	255		4600	Yes	7.72
HG-3000-200	200	495	295		4700	Yes	8.70

<sup>(1)</sup> other strokes under request

<sup>(2)</sup> alternative forces upon request

<sup>(3)</sup> ESK available for other strokes



Pressure medium	N <sub>2</sub>	Working temperature	0-80°C	Min. security stroke	10%
Max. Charging pressure	150 bar	Temperature related force increase	+0.34%/°C	Repair Kit	KIT HG-3000
Min. Charging pressure	25 bar	Max. working speed	1.6 m/s	Linkable	G1/8"

### Mounting possibilities

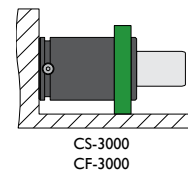
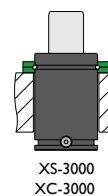
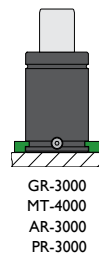
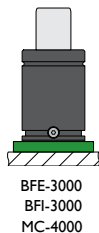
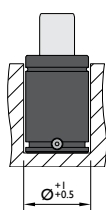
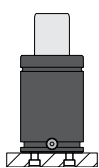

Flange must not support spring's force

## Flanges

**BFE-3000**

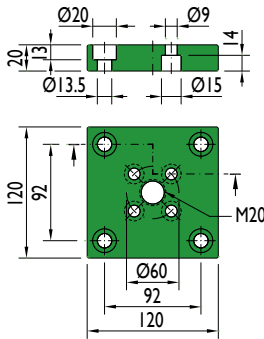

**BFI-3000**

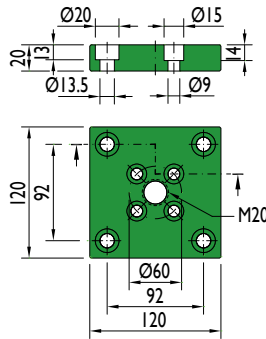

**MC-4000**

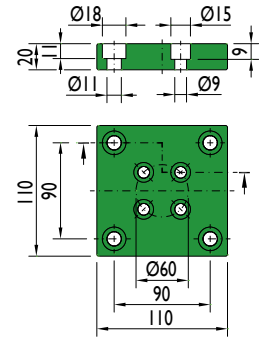

**GR-3000**

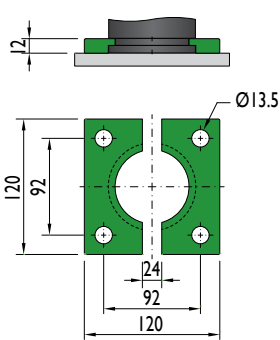

**MT-4000**

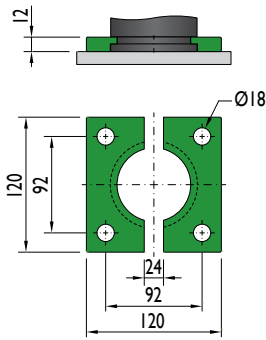

**AR-3000**

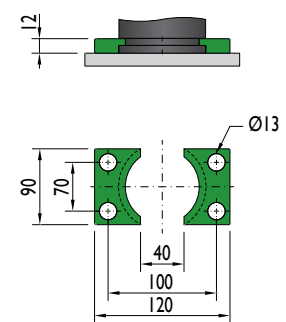

**XS-3000**

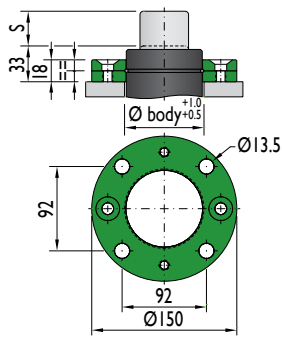

**XC-3000**

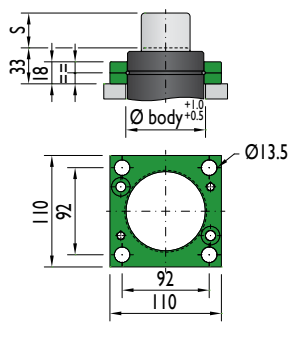

**PR-3000**

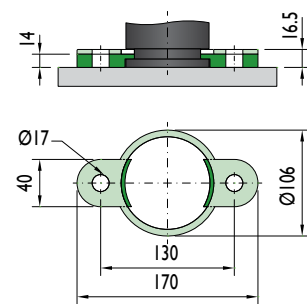

**CS-3000**

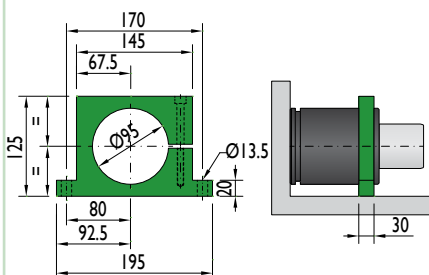

Flange must not support spring's force

**CF-3000**

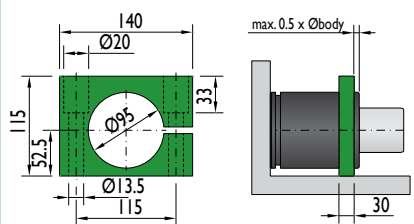

Flange must not support spring's force



CNOMO  
EM24.54.700

PSA  
E24.54.815.G

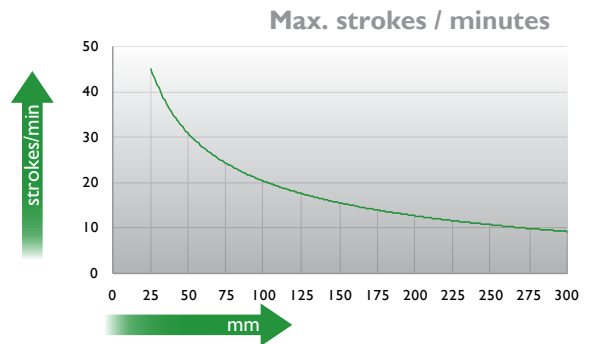
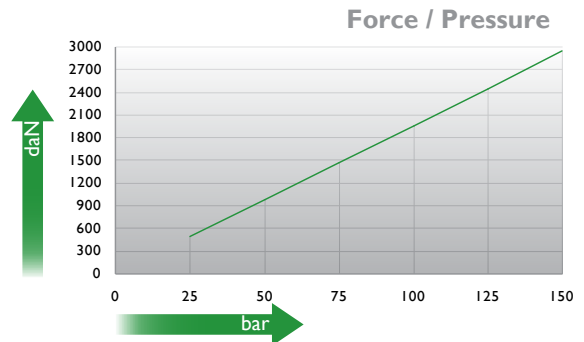
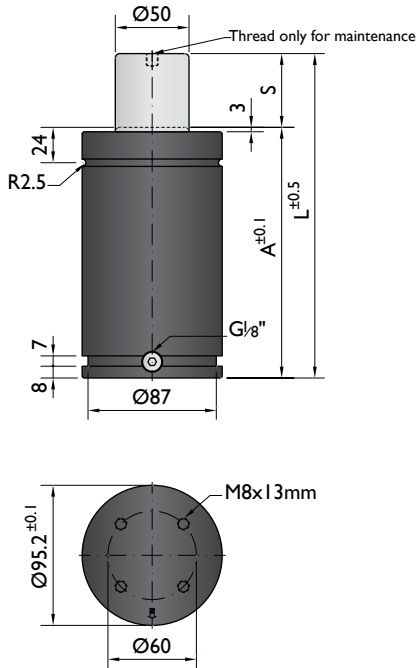

Ordering example: 4 x G-3000-125

Order No.	S <sup>(1)</sup> mm	L mm	A mm	F <sub>0</sub> <sup>(2)</sup> daN (20°C, 150 bar)	F daN	 <sup>(3)</sup>	kg
G-3000-25	25	170	145		3500	No	5.86
G-3000-38	38.1	196.2	158.1		3700	No	6.20
G-3000-50	50	220	170		3800	No	6.66
G-3000-63	63.5	247	183.5		3900	No	7.00
G-3000-80	80	280	200		4000	No	8.28
G-3000-100	100	320	220	3000	4200	Yes	8.65
G-3000-125	125	370	245		4200	Yes	8.97
G-3000-160	160	440	280		4200	Yes	9.86
G-3000-200	200	520	320		4300	Yes	10.92
G-3000-250	250	620	370		4300	Yes	12.25
G-3000-300	300	720	420		4400	Yes	13.58

<sup>(1)</sup> other strokes under request

<sup>(2)</sup> alternative forces upon request

<sup>(3)</sup> ESK available for other strokes



Pressure medium	N <sub>2</sub>	Working temperature	0-80°C	Min. security stroke	10%
Max. Charging pressure	150 bar	Temperature related force increase	+0.34%/°C	Repair Kit	KIT G-3000
Min. Charging pressure	25 bar	Max. working speed	1.6 m/s	Linkable	G1/8"

## Mounting possibilities

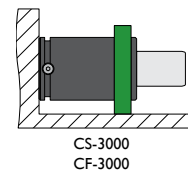
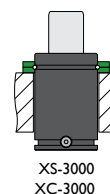
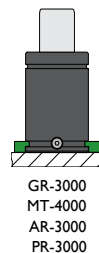
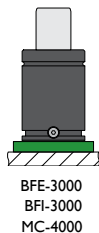
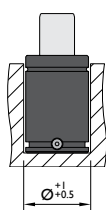
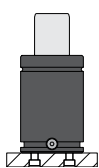

Flange must not support spring's force

## Flanges

**BFE-3000**

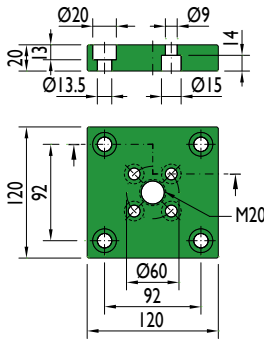

**BFI-3000**

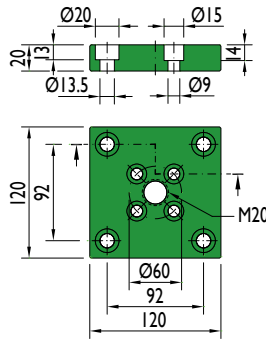

**MC-4000**

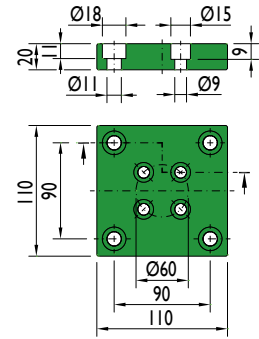

**GR-3000**

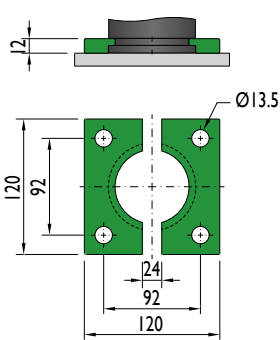

**MT-4000**

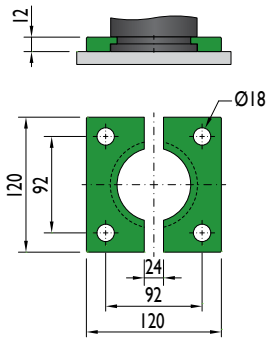

**AR-3000**

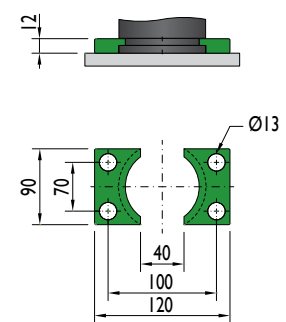

**XS-3000**

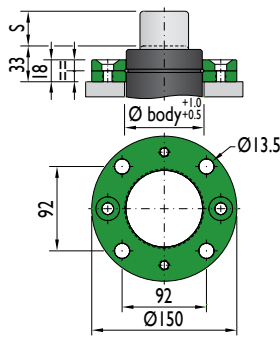

**XC-3000**

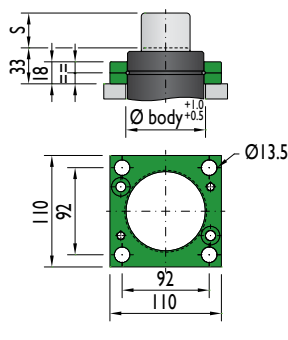

**PR-3000**

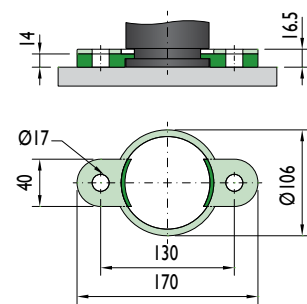

**CS-3000**

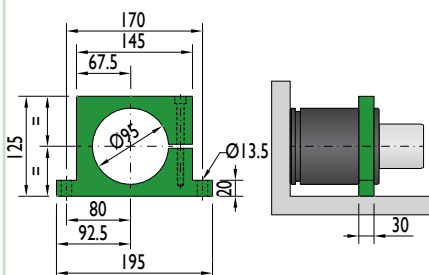

Flange must not support spring's force

**CF-3000**

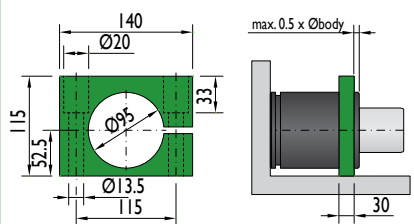

Flange must not support spring's force

Special mounts available on  
[www.nitrogas.com](http://www.nitrogas.com)

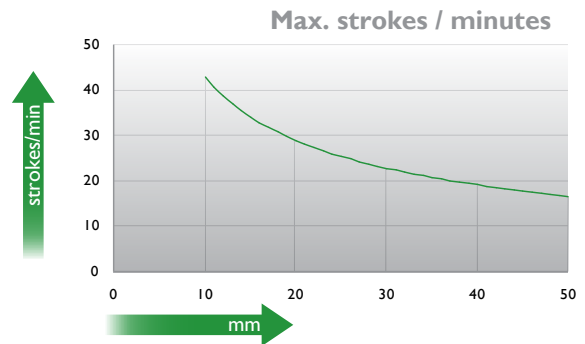
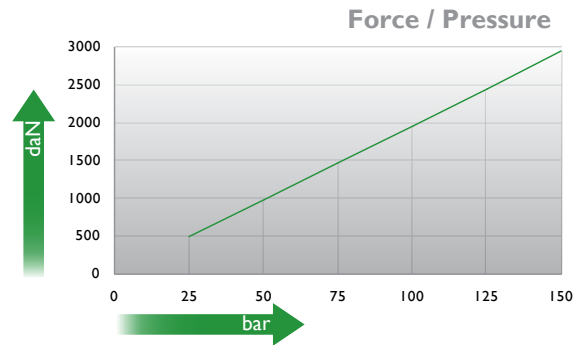
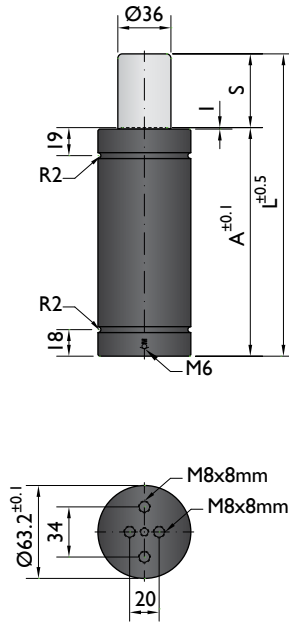

Ordering example: 4 x T-3000-50

Order No.	S <sup>(1)</sup> mm	L mm	A mm	F <sub>0</sub> <sup>(2)</sup> daN	F daN	ESK <sup>(3)</sup>	kg
				(20°C, 150 bar)			
T-3000-10	10	85	75	3000	4100	No	1.15
T-3000-16	16	103	87		4400	No	1.35
T-3000-25	25	130	105		4600	No	1.54
T-3000-32	32	150	118		4800	No	1.77
T-3000-40	40	175	135		4800	No	2.02
T-3000-50	50	205	155		4900	No	2.31
		(1) other strokes under request			(2) alternative forces upon request		(3) ESK under request



Pressure medium	N <sub>2</sub>	Working temperature	0-80°C	Min. security stroke	10%
Max. Charging pressure	150 bar	Temperature related force increase	+0.34%/°C	Repair Kit	KIT T-3000
Min. Charging pressure	25 bar	Max. working speed	0.5 m/s	Linkable	No

### Mounting possibilities

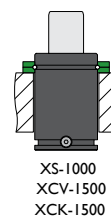
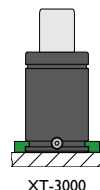
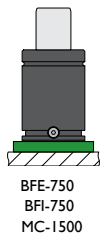
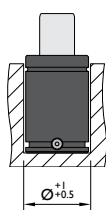
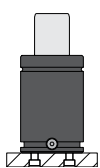

## Flanges

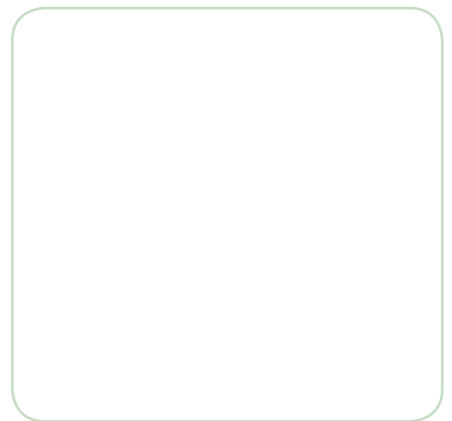
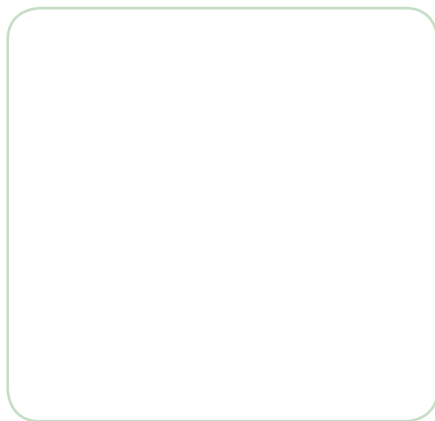
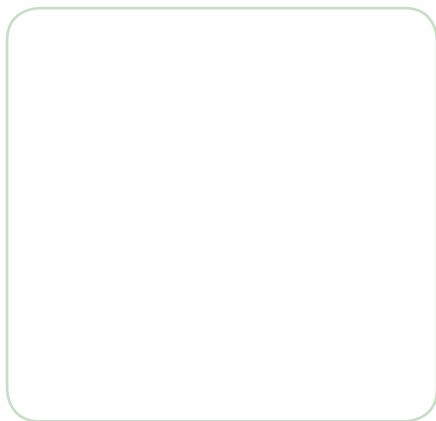
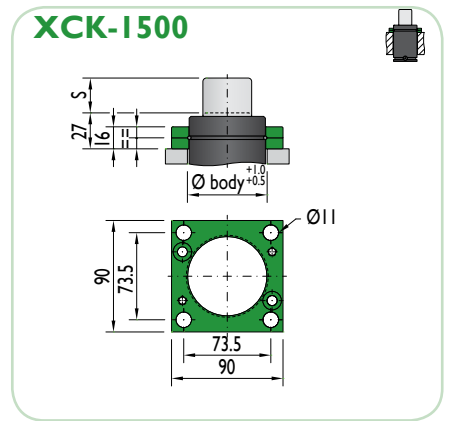
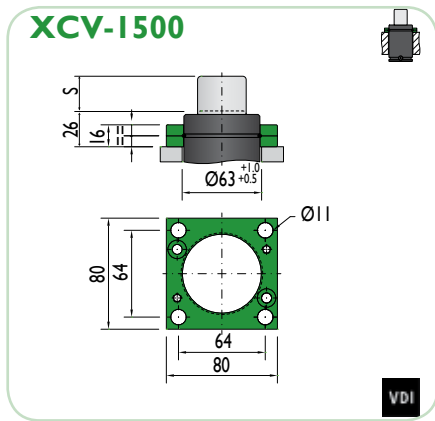
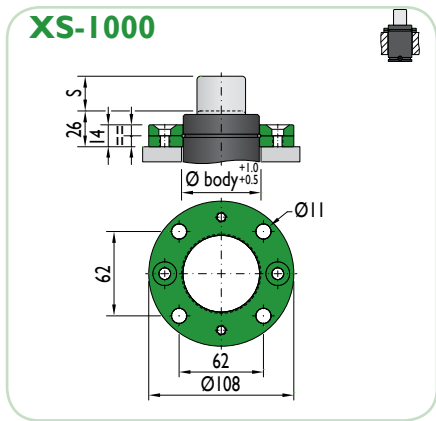
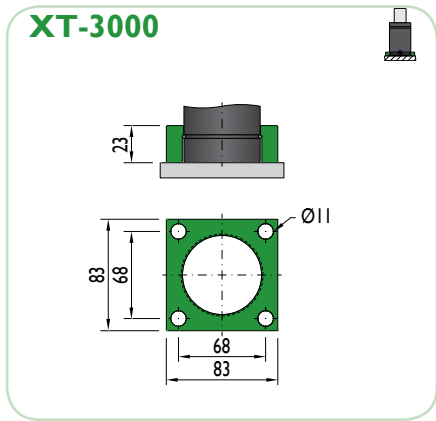
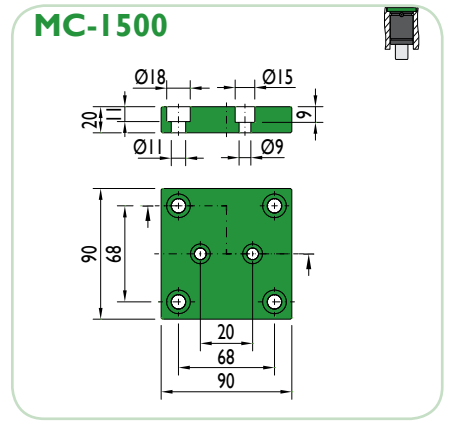
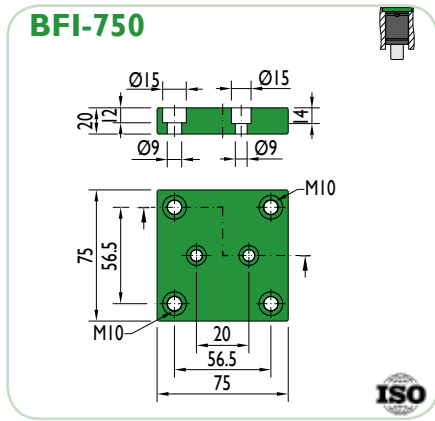
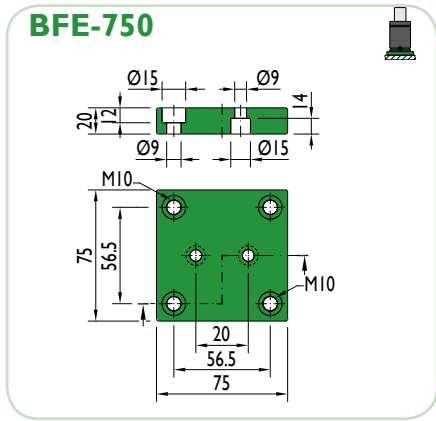

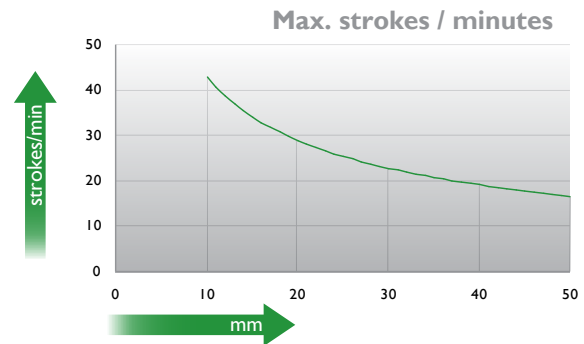
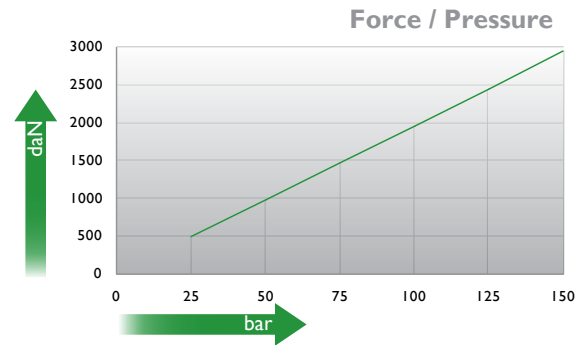
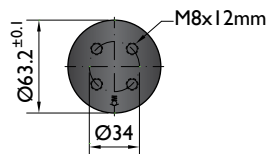
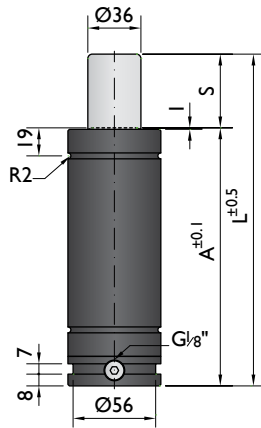

Ordering example: 4 x TC-3000-50

Order No.	S <sup>(1)</sup> mm	L mm	A mm	F <sub>0</sub> <sup>(2)</sup> daN	F daN	(3)	kg
				(20°C, 150 bar)			
TC-3000-10	10	105	95	3000	4100	No	1.55
TC-3000-16	16	123	107		4400	No	1.75
TC-3000-25	25	150	125		4600	No	1.94
TC-3000-32	32	170	138		4800	No	2.17
TC-3000-40	40	195	155		4800	No	2.42
TC-3000-50	50	225	175		4900	No	2.71

(1) other strokes under request      (2) alternative forces upon request      (3) ESK under request



Pressure medium	N <sub>2</sub>	Working temperature	0-80°C	Min. security stroke	10%
Max. Charging pressure	150 bar	Temperature related force increase	+0.34%/°C	Repair Kit	KIT TC-3000
Min. Charging pressure	25 bar	Max. working speed	0.5 m/s	Linkable	G1/8"

### Mounting possibilities

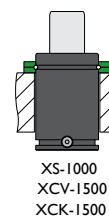
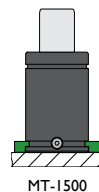
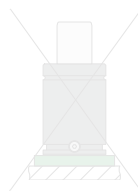
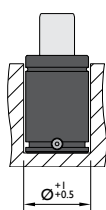
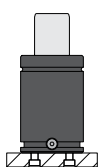

## Flanges

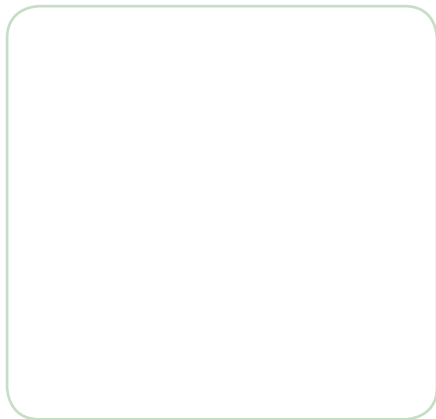
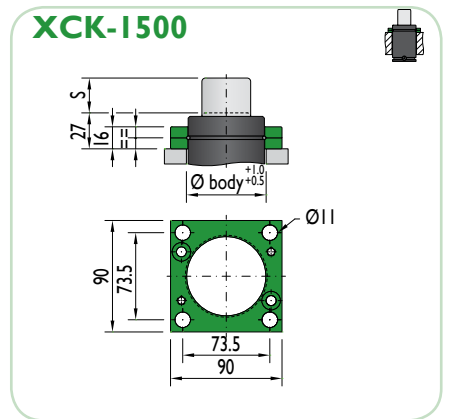
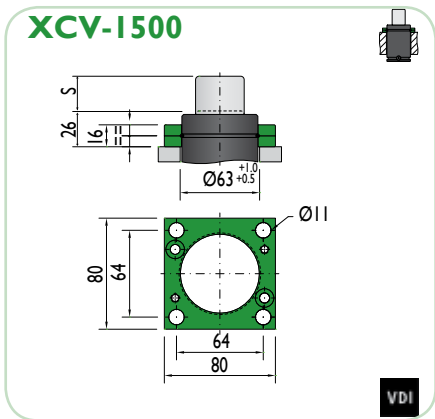
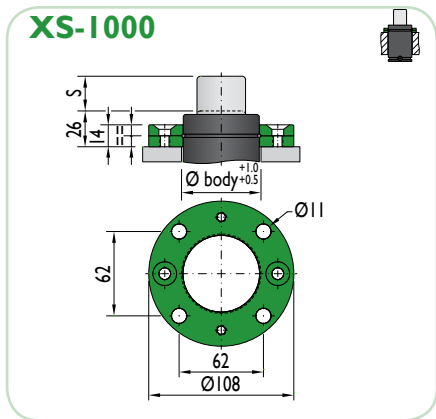
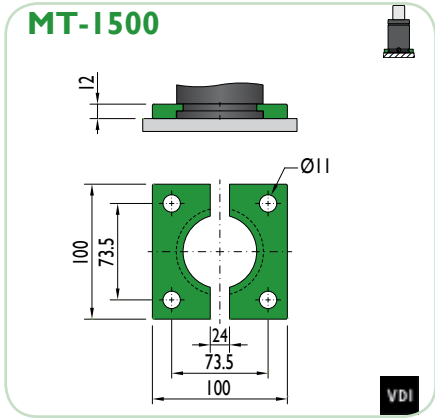



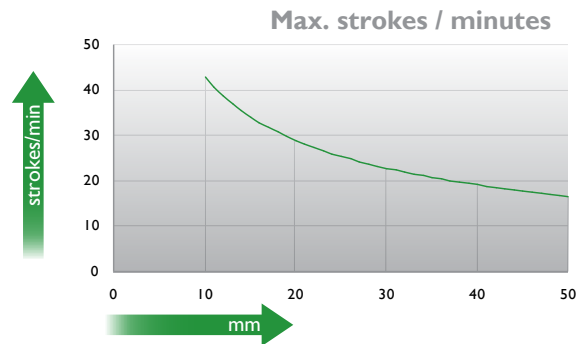
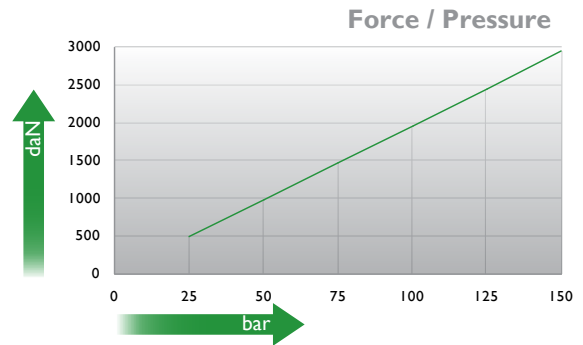
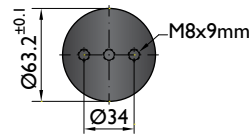
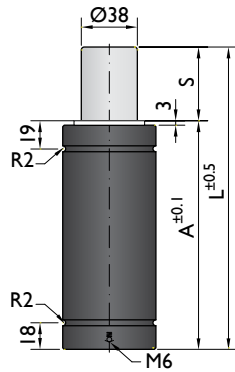

Ordering example: 4 x TS-3000-65

Order No.	S <sup>(1)</sup> mm	L mm	A mm	F <sub>0</sub> <sup>(2)</sup> daN	F daN		kg
				(20°C, 150 bar)			
TS-3000-10	10	85	75	3000	4100	No	1.15
TS-3000-16	16	103	87		4400	No	1.35
TS-3000-25	25	130	105		4600	No	1.54
TS-3000-32	32	150	118		4800	No	1.77
TS-3000-40	40	175	135		4800	No	2.02
TS-3000-50	50	205	155		4900	No	2.31
TS-3000-65	65	256	191		4900	No	2.50

other strokes <sup>(1)</sup> under request

alternative forces <sup>(2)</sup> upon request

ESK <sup>(3)</sup> under request



Pressure medium	N <sub>2</sub>	Working temperature	0-80°C	Min. security stroke	10%
Max. Charging pressure	150 bar	Temperature related force increase	+0.34%/°C	Repair Kit	KIT TS-3000
Min. Charging pressure	25 bar	Max. working speed	0.5 m/s	Linkable	No

## Mounting possibilities

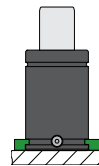
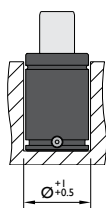
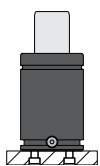

XT-3000

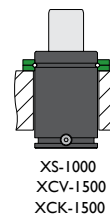

XS-1000  
XCV-1500  
XCK-1500



## Flanges



**XT-3000**

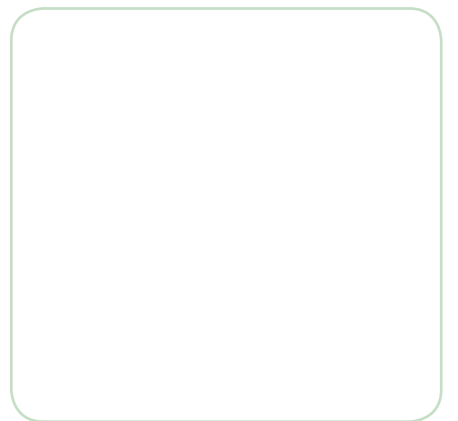
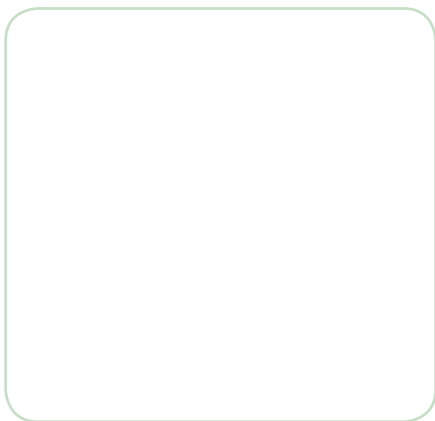

**XS-1000**

**XCV-1500**

**XCK-1500**



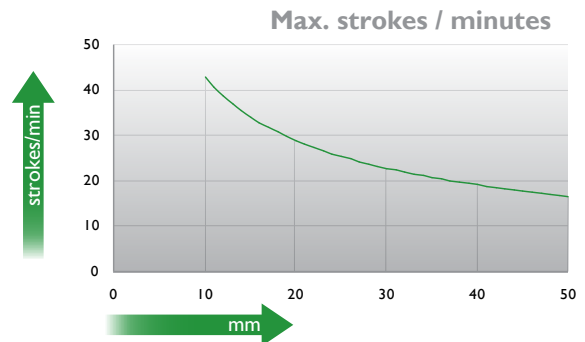
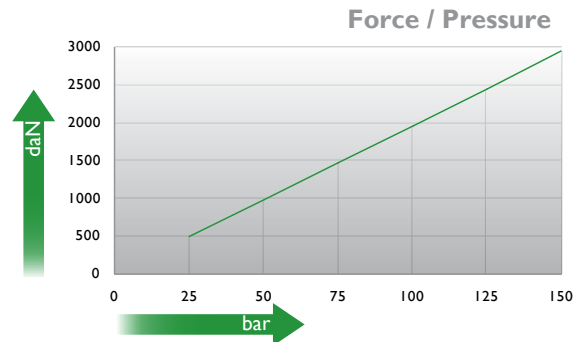
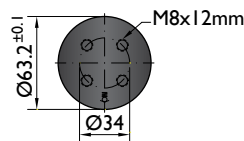
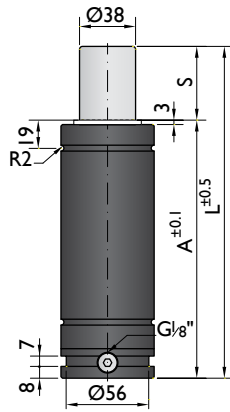

Ordering example: 4 x TSC-3000-65

Order No.	S <sup>(1)</sup> mm	L mm	A mm	F <sub>0</sub> <sup>(2)</sup> daN	F daN	(3)	kg
TSC-3000-10	10	105	95	3000 (20°C, 150 bar)	4100	No	1.55
TSC-3000-16	16	123	107		4400	No	1.75
TSC-3000-25	25	150	125		4600	No	1.94
TSC-3000-32	32	170	138		4800	No	2.17
TSC-3000-40	40	195	155		4800	No	2.42
TSC-3000-50	50	225	175		4900	No	2.71
TSC-3000-65	65	276	211		4900	No	2.90

other strokes <sup>(1)</sup> under request

alternative forces <sup>(2)</sup> upon request

ESK <sup>(3)</sup> under request



Pressure medium	N <sub>2</sub>	Working temperature	0-80°C	Min. security stroke	10%
Max. Charging pressure	150 bar	Temperature related force increase	+0.34%/°C	Repair Kit	KIT TSC-3000
Min. Charging pressure	25 bar	Max. working speed	0.5 m/s	Linkable	G1/8"

### Mounting possibilities

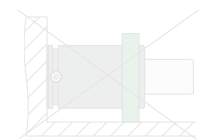
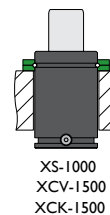
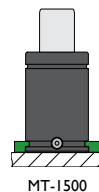
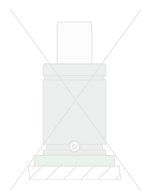
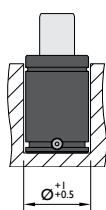
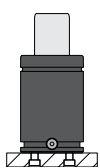

## Flanges



**MT-1500**

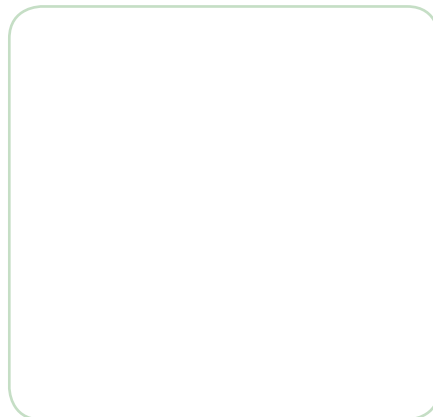

**XS-1000**

**XCV-1500**

**XCK-1500**

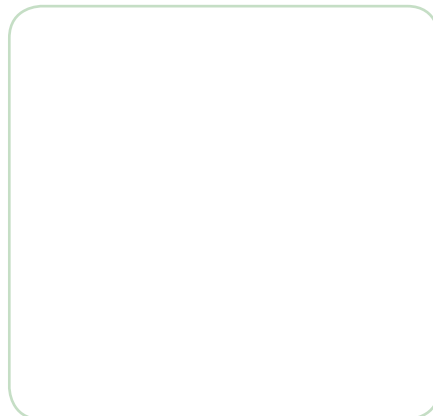
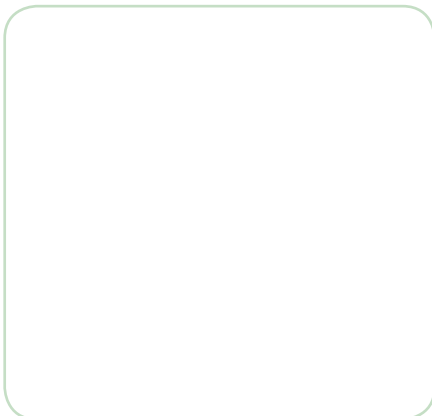

## Force 4000 daN

### Piston Rod Sealed gas springs

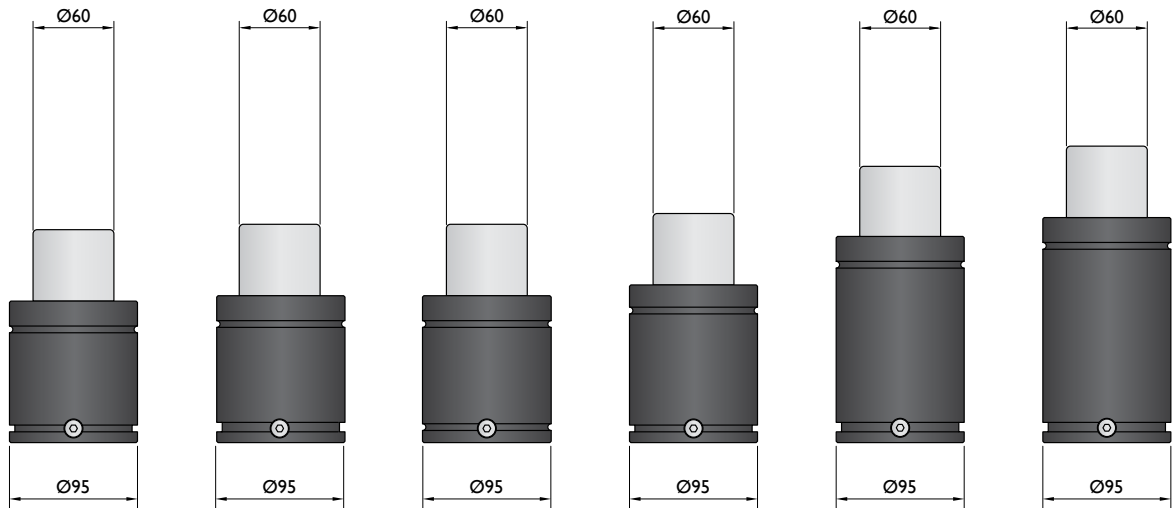
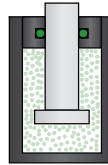

Model	KP-4200	NR-4200	NT-4200	K-4000	M-4000	HD-4200
Initial F (daN)	4200	4200	4200	4000	4000	4200
L max (mm)	2xStroke+58	2xStroke+62	2xStroke+62	2xStroke+70	2xStroke+110	2xStroke+120
Stroke (mm)	16-125	16-125	16-125	25-125	25-160	25-300

\* other strokes under request

### Standards

PED	PED	PED	PED	PED	PED
97/23/EC	97/23/EC	97/23/EC	97/23/EC	97/23/EC	97/23/EC
ISO	ISO	ISO	ISO	ISO	ISO
11901	11901	11901	11901	11901	11901
VDI	VDI	VDI	VDI	VDI	VDI
3003	3003	3003	3003	3003	3003
CNOMO	CNOMO	CNOMO	CNOMO	CNOMO	CNOMO
EM24.54.700	EM24.54.700	EM24.54.700	EM24.54.700	EM24.54.700	EM24.54.700





PSA  
E24.54.815.G

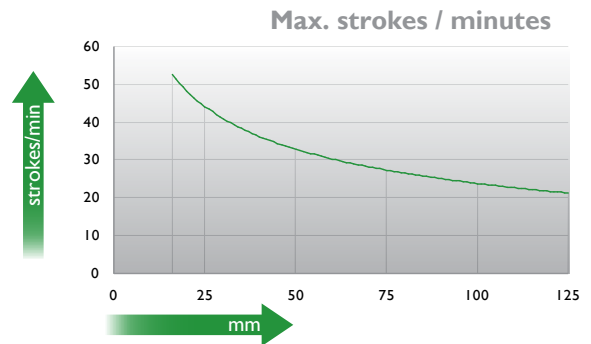
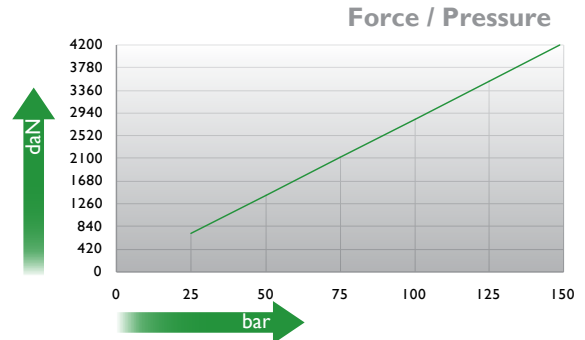
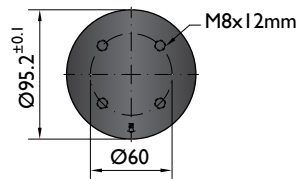
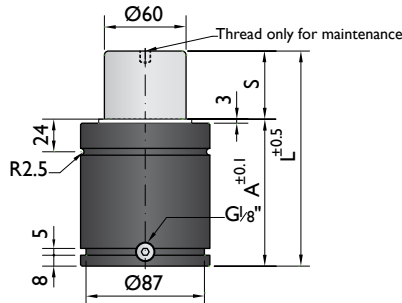

Ordering example: 4 x KP-4200-125

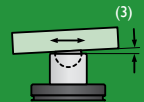
Order No.	S <sup>(1)</sup> mm	L mm	A mm	F <sub>0</sub> <sup>(2)</sup> daN (20°C, 150 bar)	F daN	 <sup>(3)</sup>	kg
KP-4200-16	16	90	74	4200	6500	No	2.82
KP-4200-19	19	96	77		6700	No	2.90
KP-4200-25	25	108	83		6900	No	3.05
KP-4200-32	32	122	90		7000	No	3.23
KP-4200-38	38	134	96		7100	No	3.38
KP-4200-50	50	158	108		7500	No	3.69
KP-4200-63	63	184	121		7600	Yes	4.02
KP-4200-75	75	208	133		7700	Yes	4.32
KP-4200-80	80	218	138		7800	Yes	4.45
KP-4200-100	100	258	158		7900	Yes	4.96
KP-4200-125	125	308	183	8000	Yes	5.60	

<sup>(1)</sup> other strokes under request

<sup>(2)</sup> alternative forces upon request

<sup>(3)</sup> ESK available for other strokes



Pressure medium	N <sub>2</sub>	Working temperature	0-80°C	Min. security stroke	10%
Max. Charging pressure	150 bar	Temperature related force increase	+0.34%/°C	Repair Kit	KIT KP-4200
Min. Charging pressure	25 bar	Max. working speed	1.6 m/s	Linkable	G1/8"

## Mounting possibilities

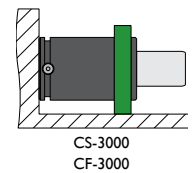
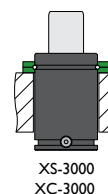
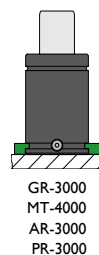
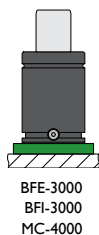
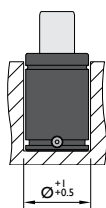
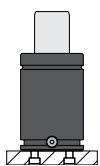

Flange must not support spring's force

## Flanges

**BFE-3000**

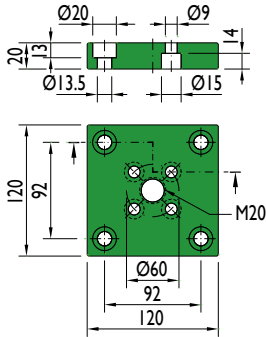

**BFI-3000**

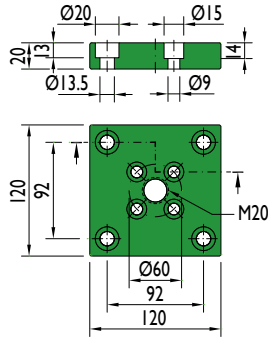

**MC-4000**

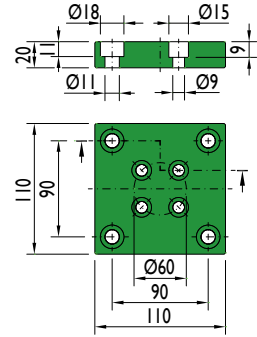

**GR-3000**

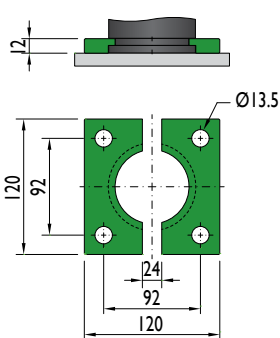

**MT-4000**

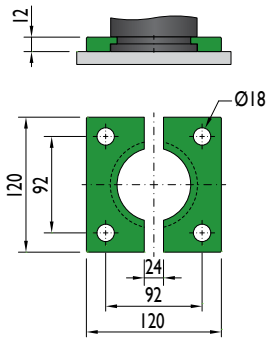

**AR-3000**

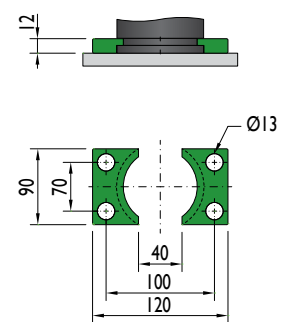

**XS-3000**

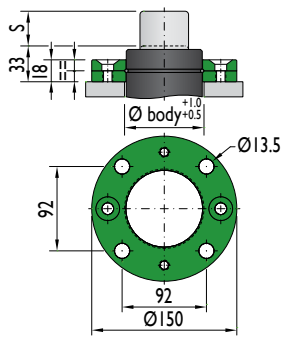

**XC-3000**

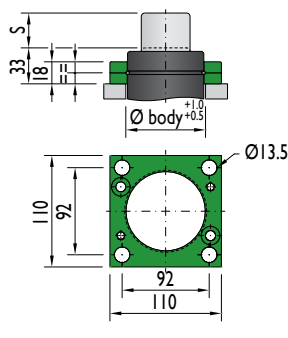

**PR-3000**

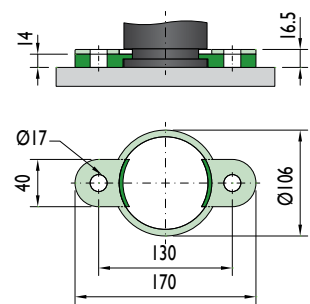

**CS-3000**

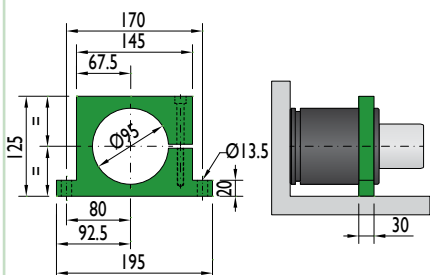

Flange must not support spring's force

**CF-3000**

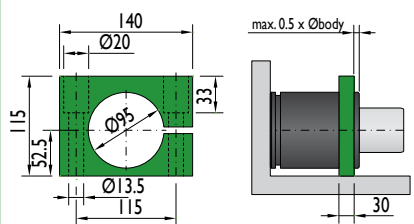

Flange must not support spring's force



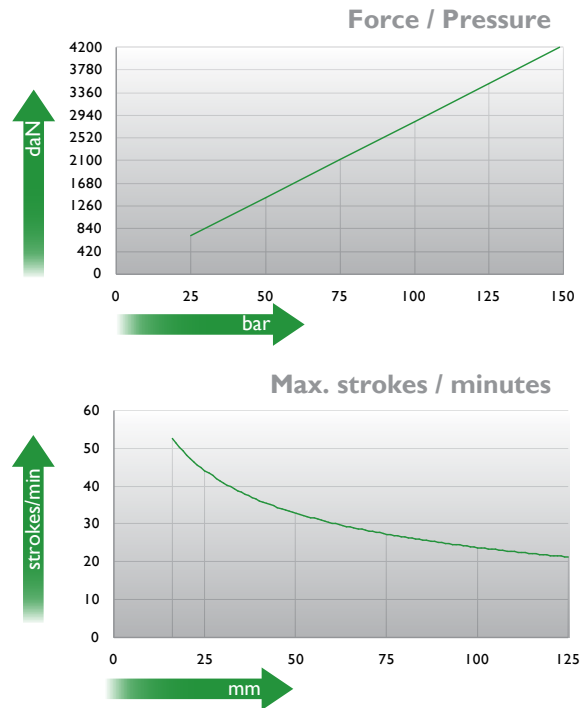
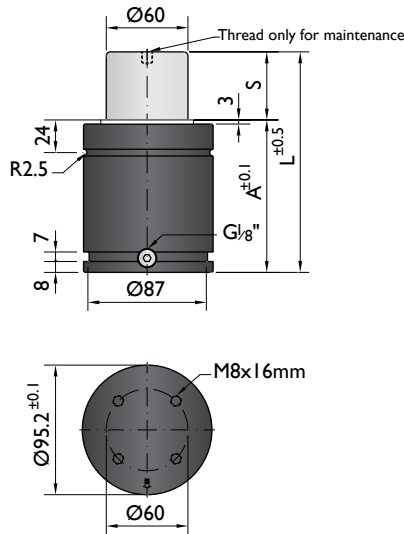

Ordering example: 4 x NR-4200-125

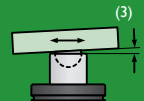
Order No.	S <sup>(1)</sup> mm	L mm	A mm	F <sub>0</sub> <sup>(2)</sup> daN (20°C, 150 bar)	F daN	 <sup>(3)</sup>	kg
NR-4200-16	16	94	78	4200	6100	No	2.60
NR-4200-19	19	100	81		6300	No	2.75
NR-4200-25	25	112	87		6300	No	2.95
NR-4200-32	32	126	94		6400	No	3.17
NR-4200-38	38	138	100		6500	No	3.32
NR-4200-50	50	162	112		7700	No	3.76
NR-4200-63	63	188	125		7600	Yes	4.12
NR-4200-75	75	212	137		7600	Yes	4.50
NR-4200-80	80	222	142		7600	Yes	4.67
NR-4200-100	100	262	162		7500	Yes	5.30
NR-4200-125	125	312	187		7500	Yes	6.10

<sup>(1)</sup> other strokes under request

<sup>(2)</sup> alternative forces upon request

<sup>(3)</sup> ESK available for other strokes



Pressure medium	N <sub>2</sub>	Working temperature	0-80°C	Min. security stroke	10%
Max. Charging pressure	150 bar	Temperature related force increase	+0.34%/°C	Repair Kit	KIT NR-4200
Min. Charging pressure	25 bar	Max. working speed	1.6 m/s	Linkable	G1/8"

### Mounting possibilities

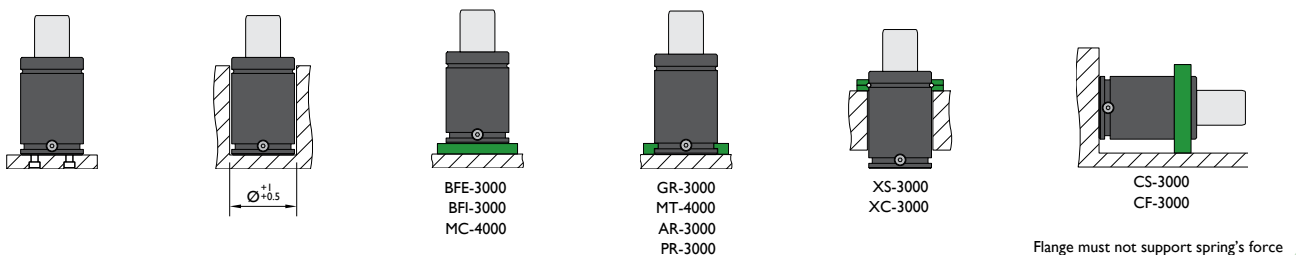

## Flanges

### BFE-3000

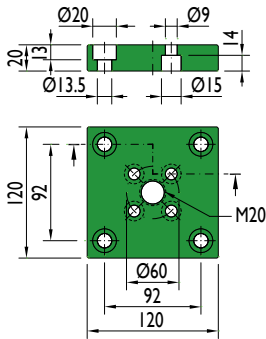

### BFI-3000

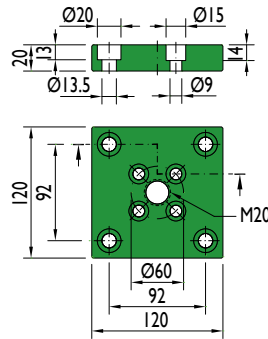

### MC-4000

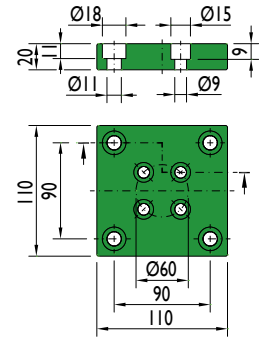

### GR-3000

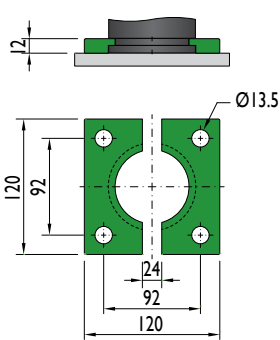

### MT-4000

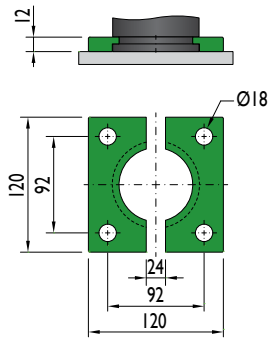

### AR-3000

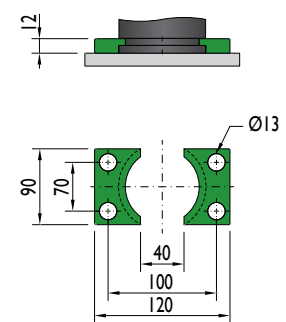

### XS-3000

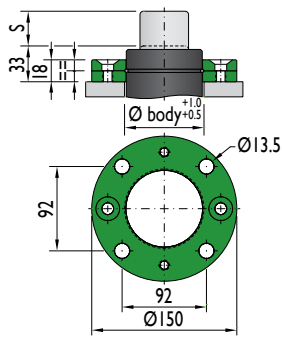

### XC-3000

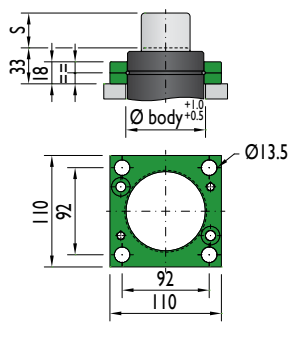

### PR-3000

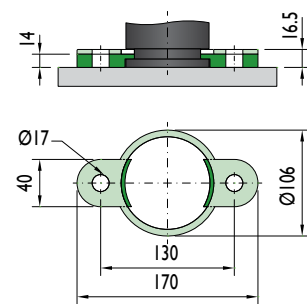

### CS-3000

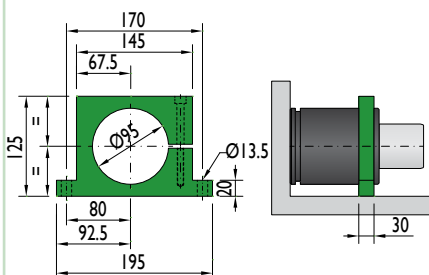

Flange must not support spring's force

### CF-3000

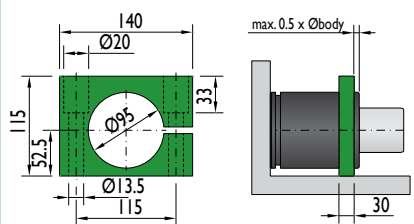

Flange must not support spring's force



PSA  
E24.54.815.G

SMS DNH  
3203N

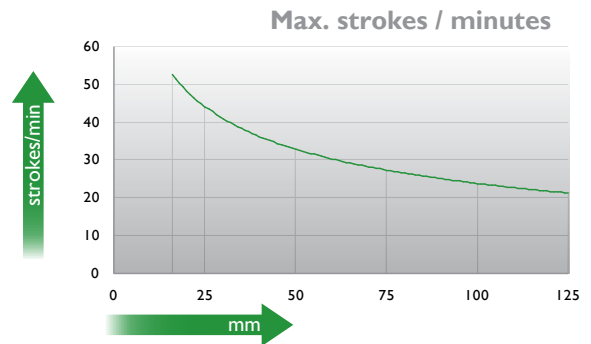
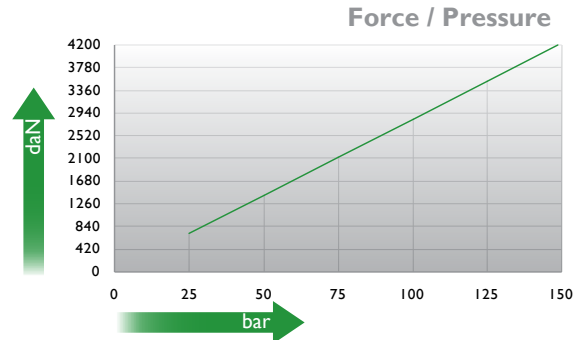
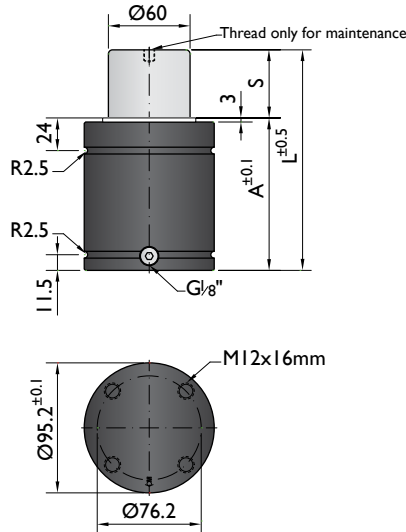

Ordering example: 4 x NT-4200-125

Order No.	S <sup>(1)</sup> mm	L mm	A mm	F <sub>0</sub> <sup>(2)</sup> daN (20°C, 150 bar)	F daN	 <sup>(3)</sup>	kg
NT-4200-16	16	94	78	4200	6100	No	2.60
NT-4200-19	19	100	81		6300	No	2.75
NT-4200-25	25	112	87		6300	No	2.95
NT-4200-32	32	126	94		6400	No	3.17
NT-4200-38	38	138	100		6500	No	3.32
NT-4200-50	50	162	112		7700	No	3.76
NT-4200-63	63	188	125		7600	Yes	4.12
NT-4200-75	75	212	137		7600	Yes	4.50
NT-4200-80	80	222	142		7600	Yes	4.67
NT-4200-100	100	262	162		7500	Yes	5.30
NT-4200-125	125	312	187		7500	Yes	6.10

<sup>(1)</sup> other strokes under request

<sup>(2)</sup> alternative forces upon request

<sup>(3)</sup> ESK available for other strokes



Pressure medium	N <sub>2</sub>	Working temperature	0-80°C	Min. security stroke	10%
Max. Charging pressure	150 bar	Temperature related force increase	+0.34%/°C	Repair Kit	KIT NT-4200
Min. Charging pressure	25 bar	Max. working speed	1.6 m/s	Linkable	G1/8"

## Mounting possibilities

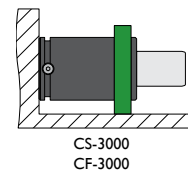
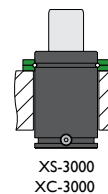
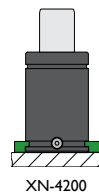
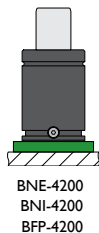
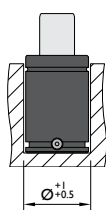
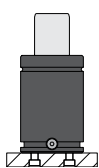

Flange must not support spring's force

## Flanges

**BNE-4200**

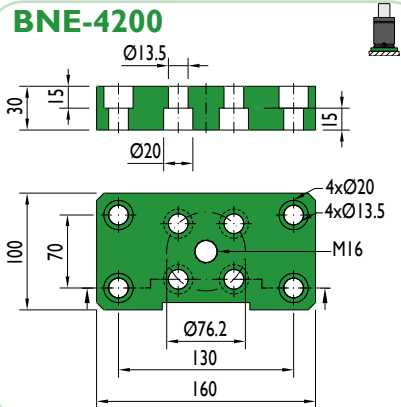

**BNI-4200**

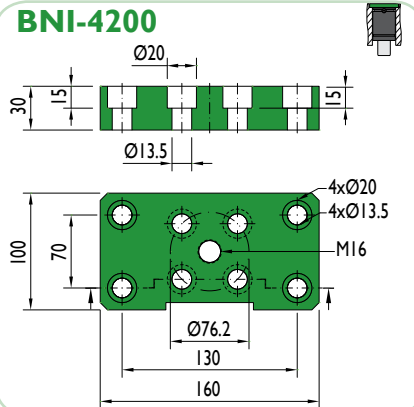

**BFP-4200**

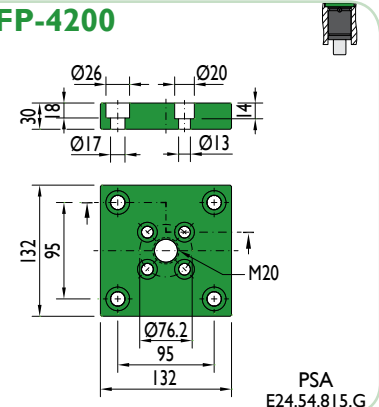

**XN-4200**

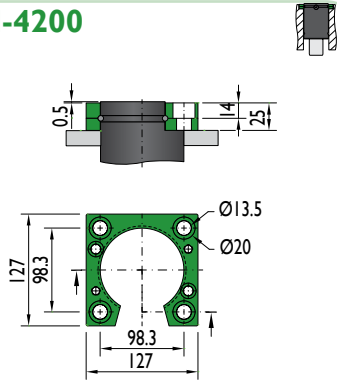

**XS-3000**

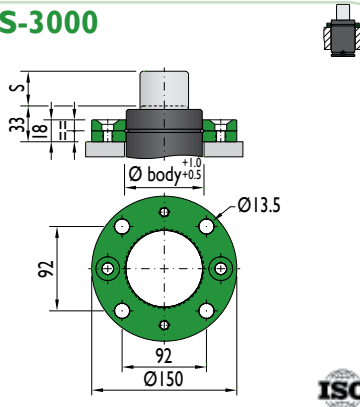

**XC-3000**

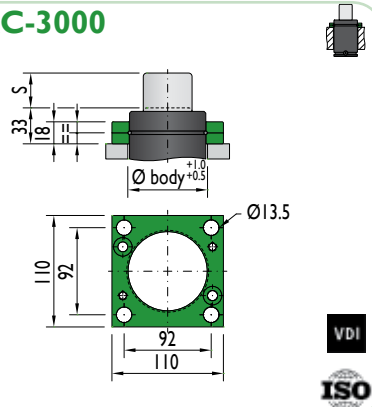

**CS-3000**

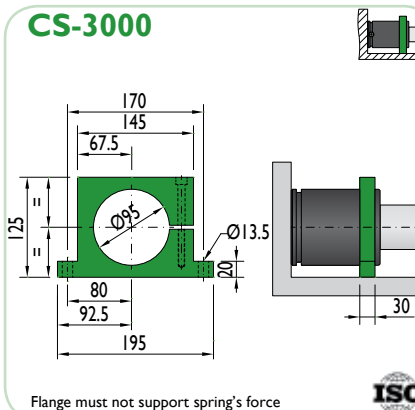

Flange must not support spring's force

**CF-3000**

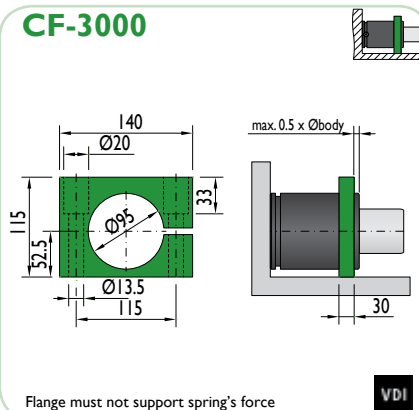

Flange must not support spring's force

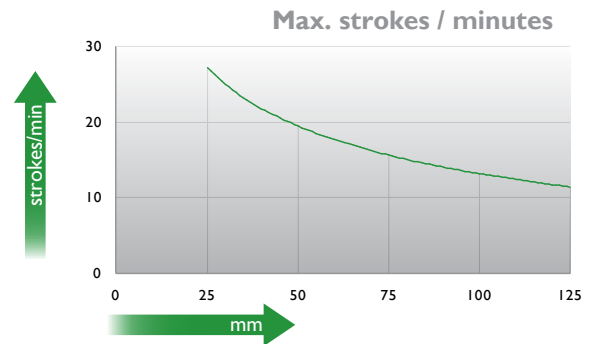
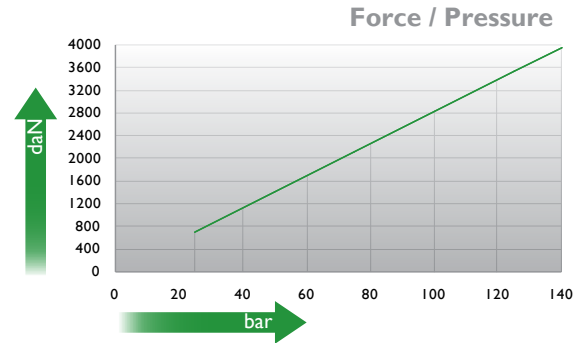
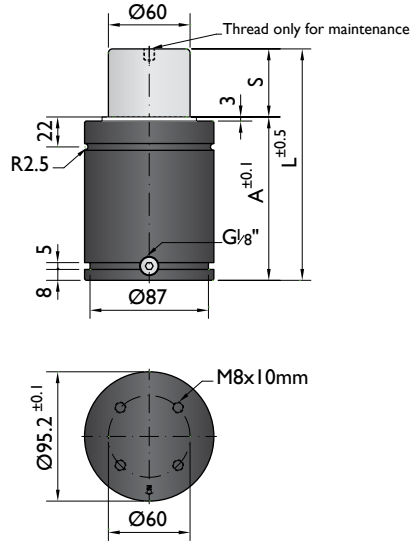

Ordering example: 4 x K-4000-125

Order No.	S <sup>(1)</sup> mm	L mm	A mm	F <sub>0</sub> <sup>(2)</sup> daN	F daN	(3)	kg
K-4000-25	25	120	95	4000 (20°C, 140 bar)	5800	No	3.76
K-4000-38	38	146	108		6200	No	4.21
K-4000-50	50	170	120		6300	No	4.50
K-4000-63	63	196	133		7100	Yes	4.82
K-4000-80	80	230	150		7100	Yes	5.26
K-4000-100	100	270	170		7200	Yes	5.63
K-4000-125	125	320	195		7200	Yes	6.05

other strokes <sup>(1)</sup> under request

alternative forces <sup>(2)</sup> upon request

ESK available <sup>(3)</sup> for other strokes



Pressure medium	N <sub>2</sub>	Working temperature	0-80°C	Min. security stroke	10%
Max. Charging pressure	140 bar	Temperature related force increase	+0.34%/°C	Repair Kit	KIT K-4000
Min. Charging pressure	25 bar	Max. working speed	1.6 m/s	Linkable	G1/8"

### Mounting possibilities

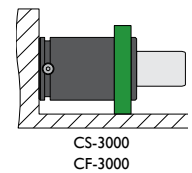
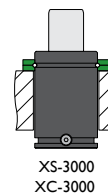
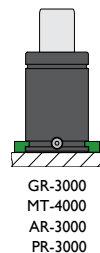
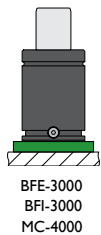
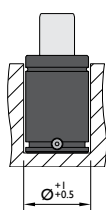
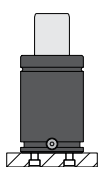

Flange must not support spring's force

## Flanges

**BFE-3000**

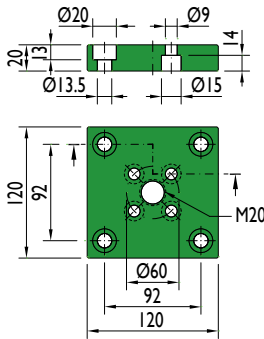

**BFI-3000**

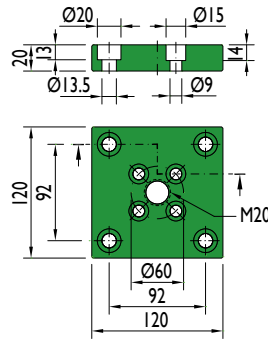

**MC-4000**

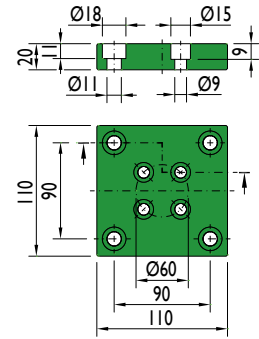

**GR-3000**

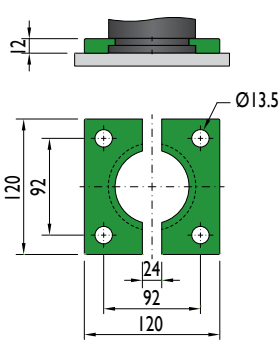

**MT-4000**

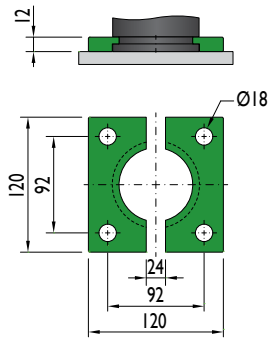

**AR-3000**

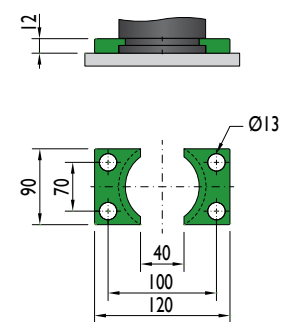

**XS-3000**

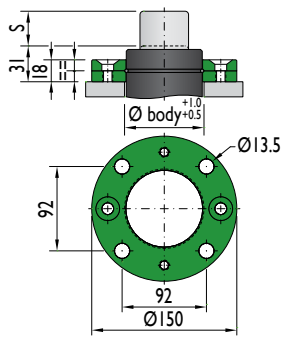

**XC-3000**

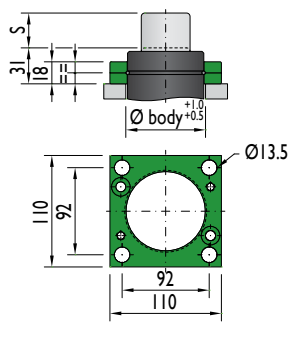

**PR-3000**

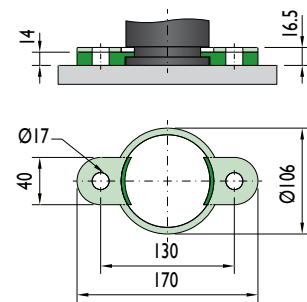

**CS-3000**

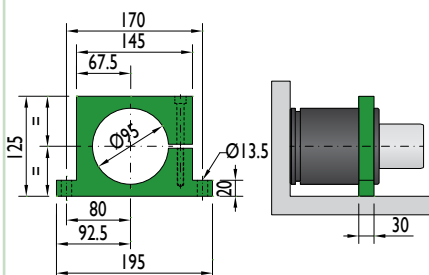

Flange must not support spring's force

**CF-3000**

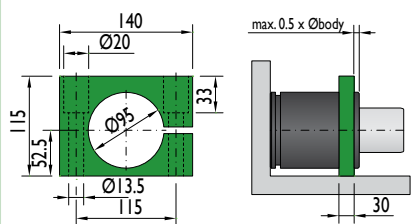

Flange must not support spring's force



\*The new cylinder will be supplied when the stock runs out.

### NEW MODEL\*

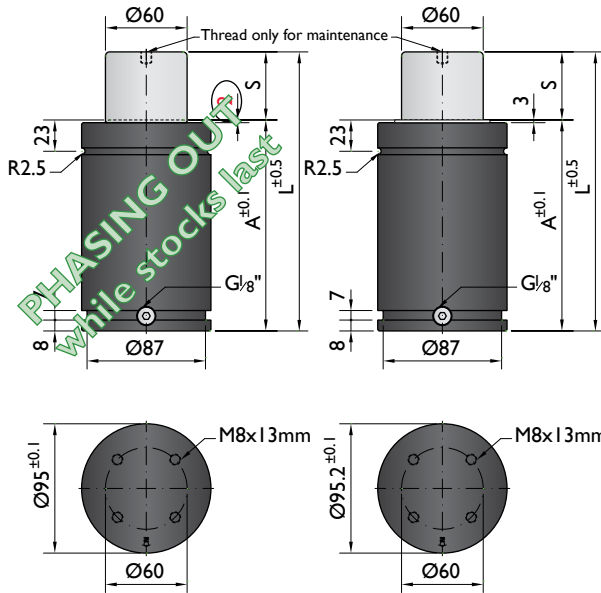

PHASING OUT  
While stocks last

### Force / Pressure

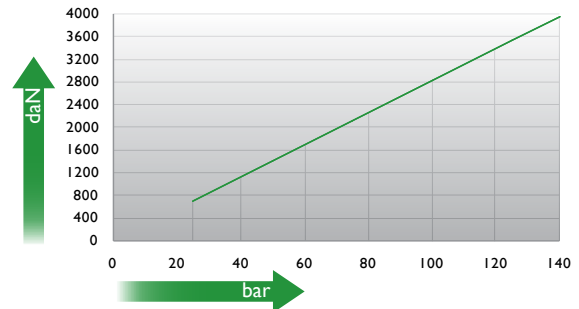

### Max. strokes / minutes

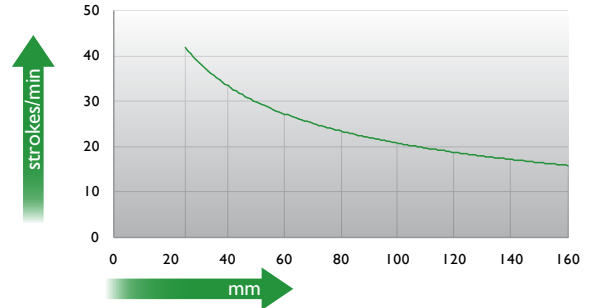

Ordering example: 4 x M-4000-125

Order No.	S <sup>(1)</sup> mm	L mm	A mm	F <sub>0</sub> <sup>(2)</sup> daN (20°C, 140 bar)	F daN		kg
M-4000-25	25	155	130	4000	5500	No	4.90
M-4000-38	38	181	143		5800	No	5.41
M-4000-50	50	205	155		6100	No	5.91
M-4000-63	63	236	173		6200	No	6.22
M-4000-80	80	270	190		6600	Yes	6.82
M-4000-100	100	310	210		6700	Yes	7.17
M-4000-125	125	370	245		6700	Yes	8.30
M-4000-160	160	440	280		6800	Yes	8.88

other strokes <sup>(1)</sup> under request

alternative forces <sup>(2)</sup> upon request

ESK available for other strokes <sup>(3)</sup>



Pressure medium	N <sub>2</sub>	Working temperature	0-80°C	Min. security stroke	10%
Max. Charging pressure	140 bar	Temperature related force increase	+0.34%/°C	Repair Kit	KIT M-4000
Min. Charging pressure	25 bar	Max. working speed	1.6 m/s	Linkable	G1/8"

### Mounting possibilities

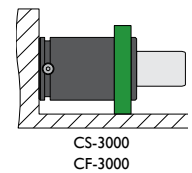
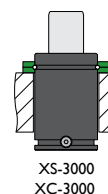
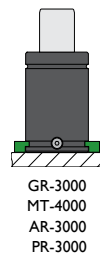
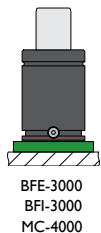
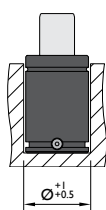
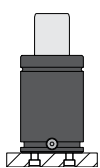

Flange must not support spring's force

## Flanges

### BFE-3000

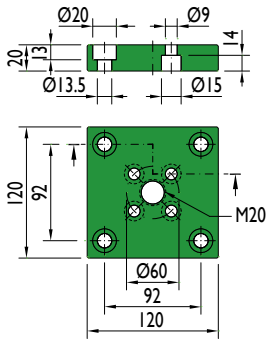

### BFI-3000

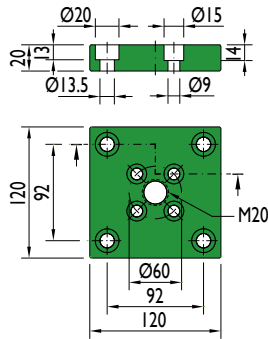

### MC-4000

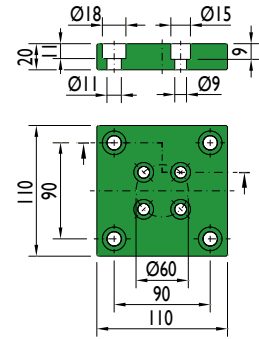

### GR-3000

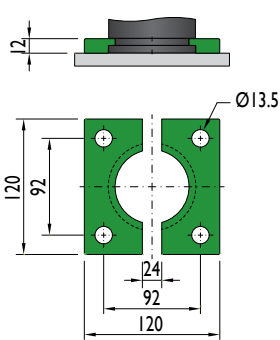

### MT-4000

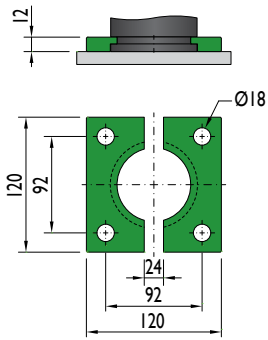

### AR-3000

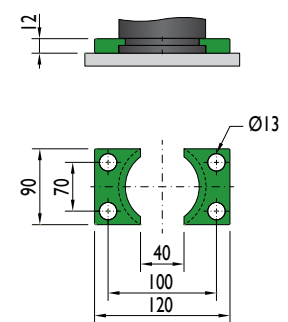

### XS-3000

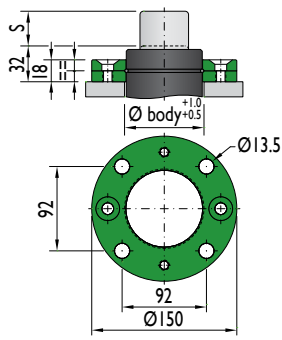

### XC-3000

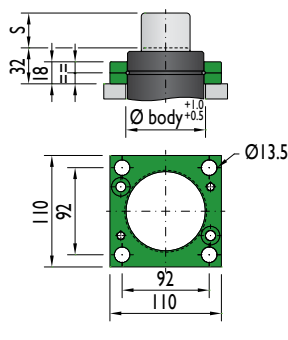

### PR-3000

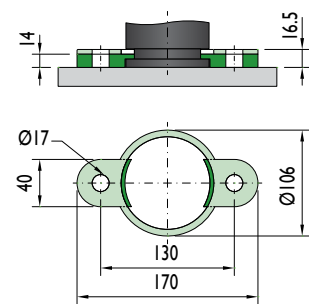

### CS-3000

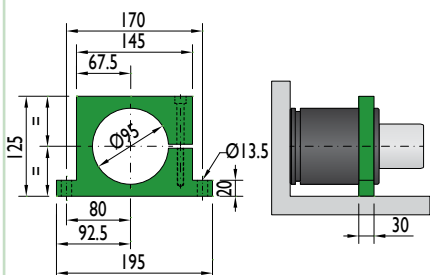

Flange must not support spring's force

### CF-3000

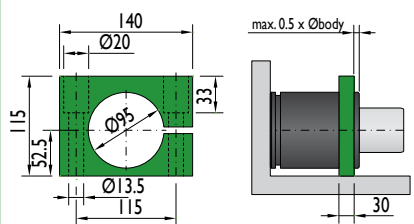

Flange must not support spring's force

Special mounts available on  
[www.nitrogas.com](http://www.nitrogas.com)



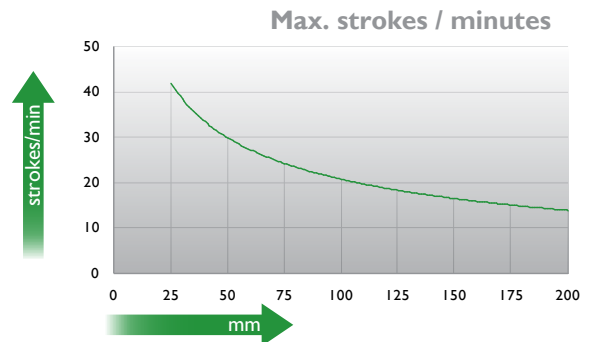
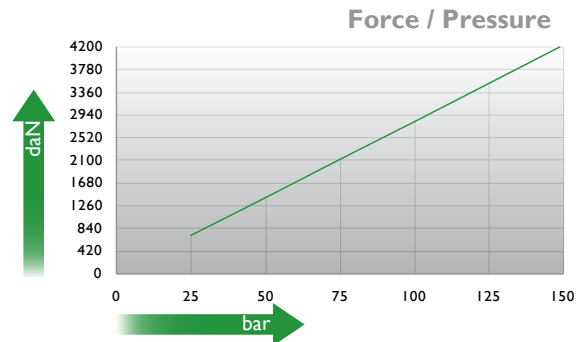
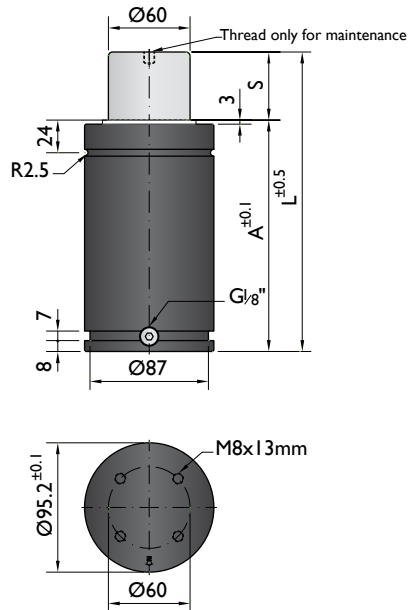

Ordering example: 4 x HD-4200-125

Order No.	S <sup>(1)</sup> mm	L mm	A mm	F <sub>0</sub> <sup>(2)</sup> daN	F daN	(3)	kg
HD-4200-25	25	170	145	4200	5500	No	6.18
HD-4200-38	38	196	158		5900	No	6.52
HD-4200-50	50	220	170		6100	No	7.20
HD-4200-63	63	246	183		6400	No	7.56
HD-4200-80	80	280	200		6900	Yes	7.95
HD-4200-100	100	320	220		7100	Yes	8.22
HD-4200-125	125	370	245		7300	Yes	8.95
HD-4200-160	160	440	280		7500	Yes	10.14
HD-4200-200	200	520	320		7600	Yes	11.05
HD-4200-250	250	620	370		7700	Yes	11.58
HD-4200-300	300	720	420	7800	Yes	12.65	

<sup>(1)</sup> other strokes under request

<sup>(2)</sup> alternative forces upon request

<sup>(3)</sup> ESK available for other strokes



Pressure medium	N <sub>2</sub>	Working temperature	0-80°C	Min. security stroke	10%
Max. Charging pressure	150 bar	Temperature related force increase	+0.34%/°C	Repair Kit	KIT HD-4200
Min. Charging pressure	25 bar	Max. working speed	1.6 m/s	Linkable	G1/8"

### Mounting possibilities

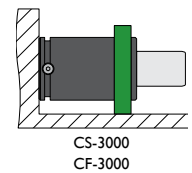
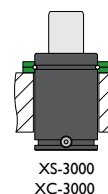
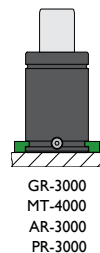
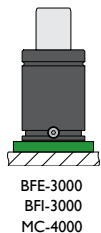
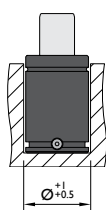
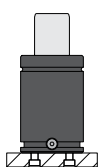

Flange must not support spring's force

## Flanges

### BFE-3000

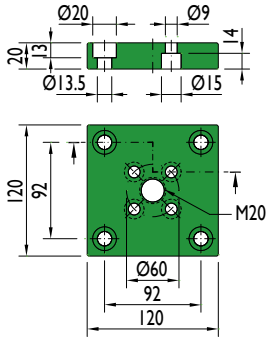

### BFI-3000

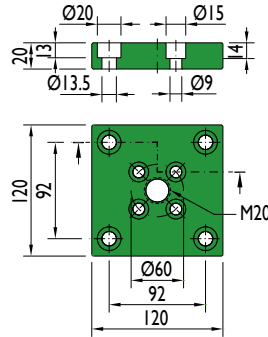

### MC-4000

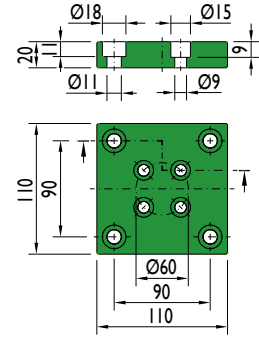

### GR-3000

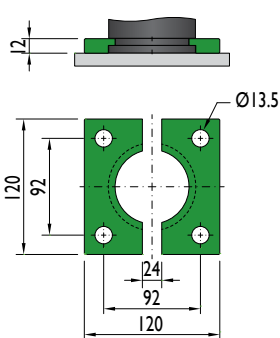

### MT-4000

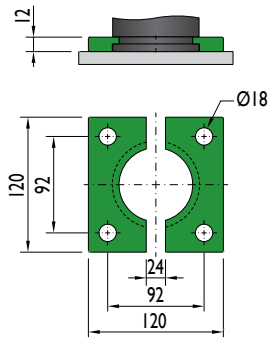

### AR-3000

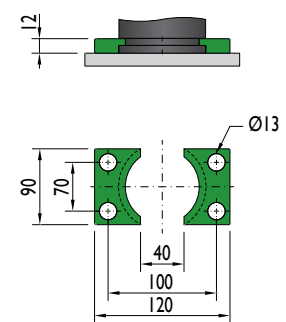

### XS-3000

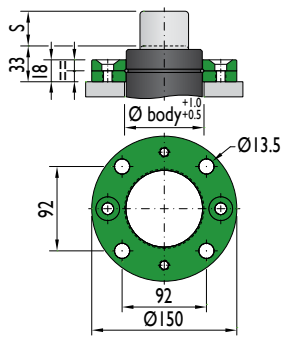

### XC-3000

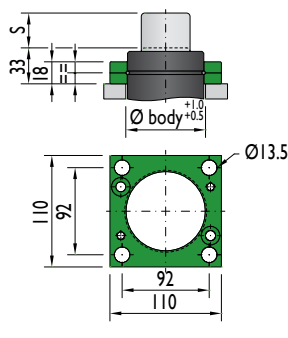

### PR-3000

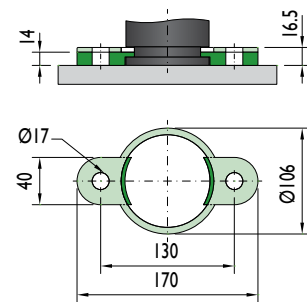

### CS-3000

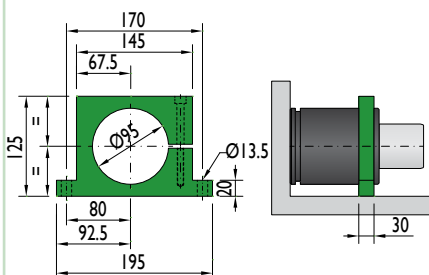

Flange must not support spring's force

### CF-3000

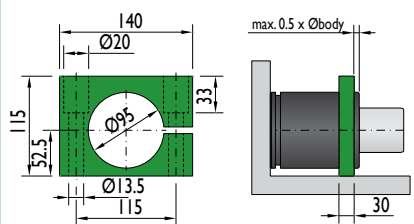

Flange must not support spring's force

## Force 5000 daN

### Piston Rod Sealed gas springs

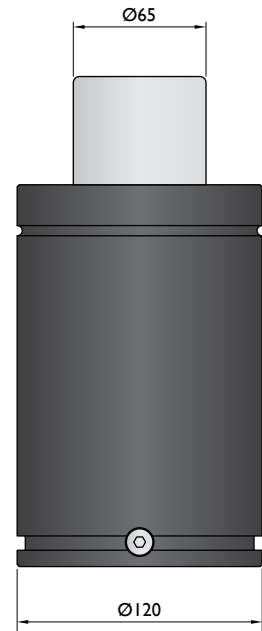
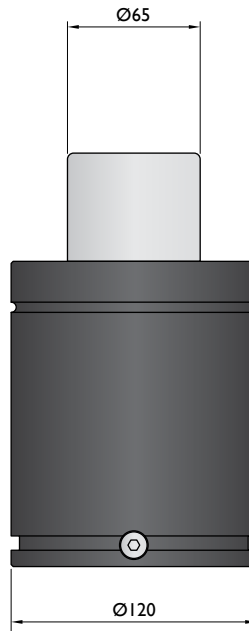
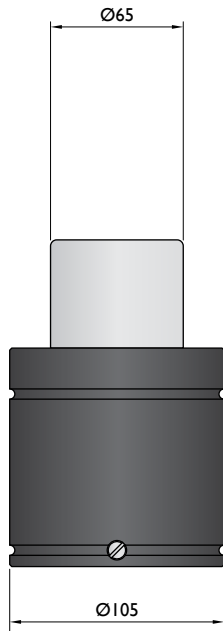
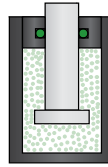

Model	KC-5000	HG-5000	G-5000
Initial F (daN)	5000	5000	5000
L max (mm)	2xStroke+60	2xStroke+102.5	2xStroke+140
Stroke (mm)	12-125	25-200	25-300

\* other strokes under request

### Standards

**PED**  
97/23/EC

**ISO**  
11901

**VDI**  
3003

**CNOMO**  
EM24.54.700

**PED**  
97/23/EC

**ISO**  
11901

**VDI**  
3003

**CNOMO**  
EM24.54.700

**PED**  
97/23/EC

**ISO**  
11901

**VDI**  
3003

**CNOMO**  
EM24.54.700

## Force 5000 daN

### Bore Sealed gas springs

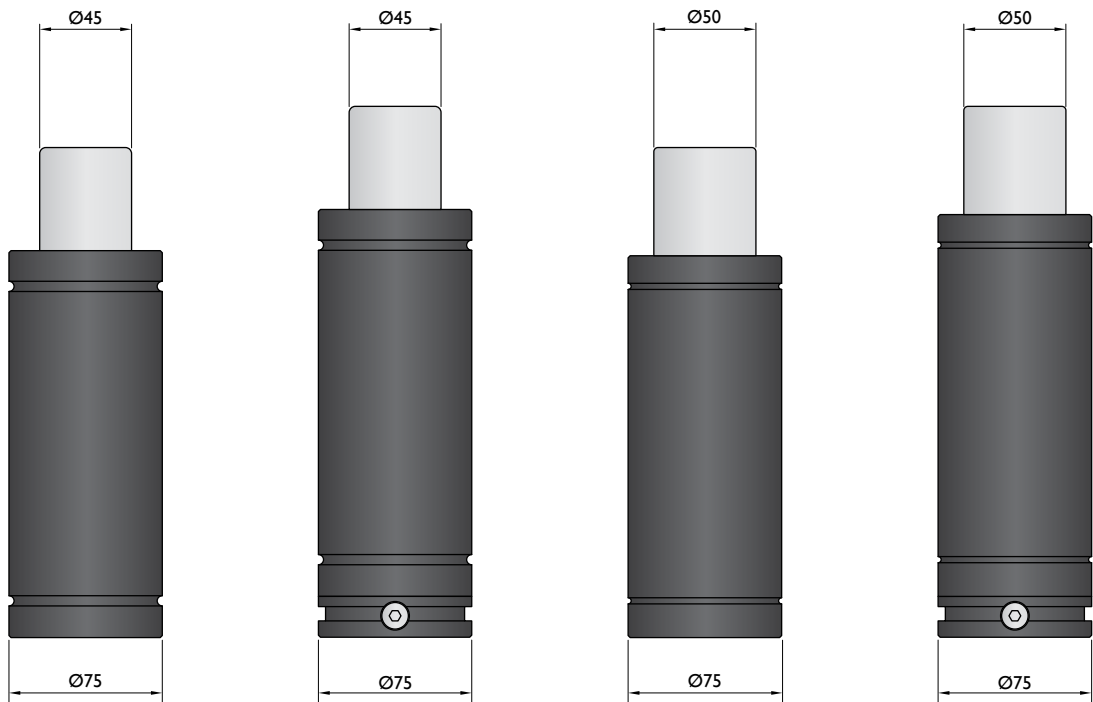
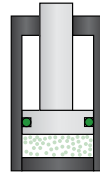

Model	T-4700	TC-4700	TS-4700	TSC-4700
Initial F (daN)	4700	4700	4700	4700
L max (mm)	80-240	100-260	80-273	100-293
Stroke (mm)	10-50	10-50	10-65	10-65

\* other strokes under request

### Standards

PED 97/23/EC	PED 97/23/EC	PED 97/23/EC	PED 97/23/EC
ISO 11901	ISO 11901	ISO 11901	ISO 11901
VDI 3003	VDI 3003	VDI 3003	VDI 3003
CNOMO EM24.54.700	CNOMO EM24.54.700	CNOMO EM24.54.700	CNOMO EM24.54.700

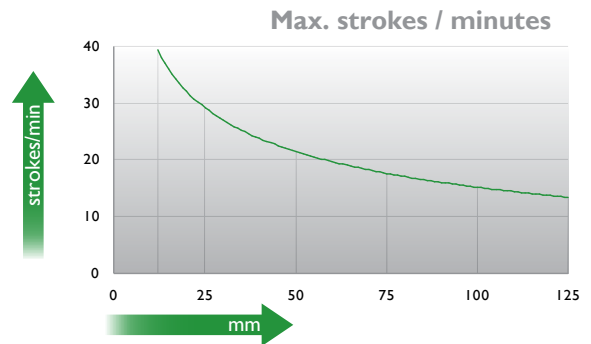
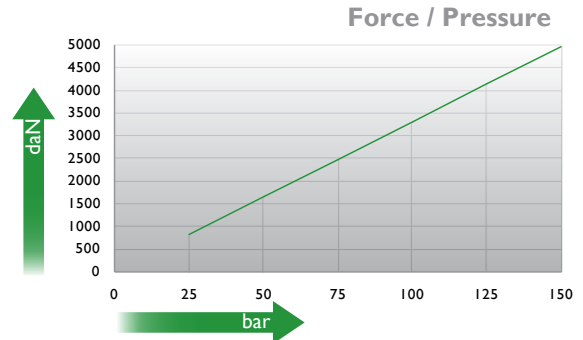
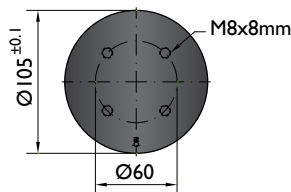
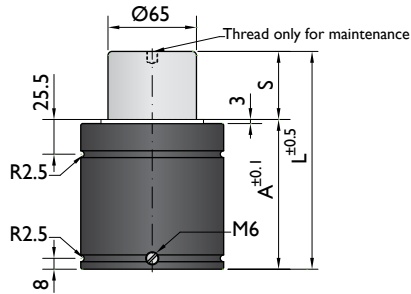

Ordering example: 4 x KC-5000-125

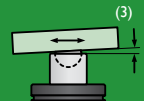
Order No.	S <sup>(1)</sup> mm	L mm	A mm	F <sub>0</sub> <sup>(2)</sup> daN (20°C, 150 bar)	F daN		kg
KC-5000-12	12	84	72	5000	7200	No	3.77
KC-5000-25	25	110	85		7800	No	4.20
KC-5000-38	38	136	98		7900	No	4.56
KC-5000-50	50	160	110		8800	Yes	4.90
KC-5000-63	63	186	123		8700	Yes	5.40
KC-5000-80	80	220	140		8700	Yes	5.96
KC-5000-100	100	260	160		8700	Yes	6.74
KC-5000-125	125	310	185		8700	Yes	7.58

other strokes <sup>(1)</sup> under request

alternative forces <sup>(2)</sup> upon request

ESK available <sup>(3)</sup> for other strokes



Pressure medium	N <sub>2</sub>	Working temperature	0-80°C	Min. security stroke	10%
Max. Charging pressure	150 bar	Temperature related force increase	+0.34%/°C	Repair Kit	KIT KC-5000
Min. Charging pressure	25 bar	Max. working speed	1.6 m/s	Linkable	M6

## Mounting possibilities

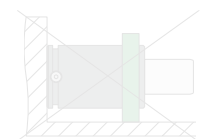
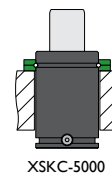
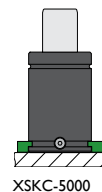
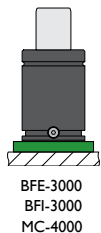
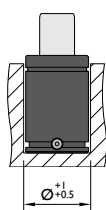
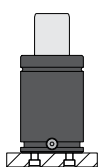

## Flanges

**BFE-3000**

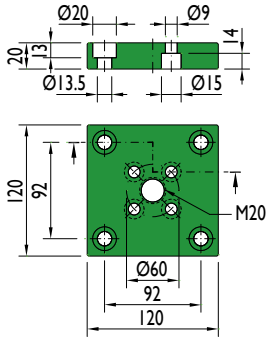

**BFI-3000**

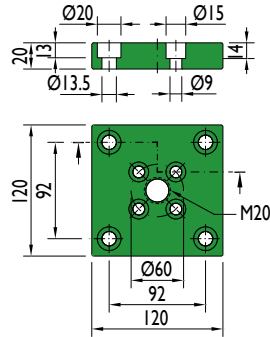

**MC-4000**

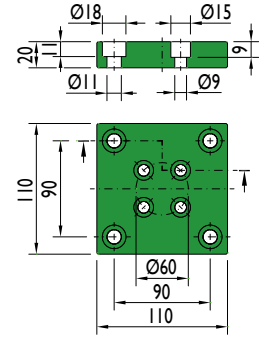

**XSKC-5000**

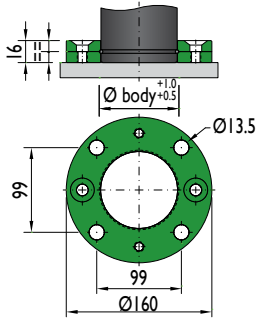

**XSKC-5000**

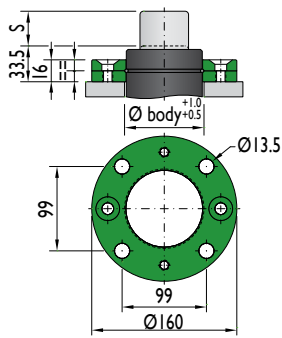

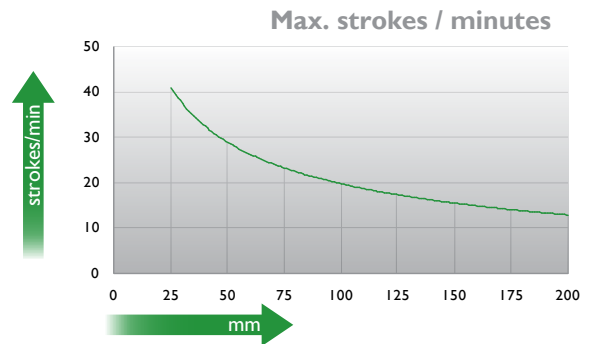
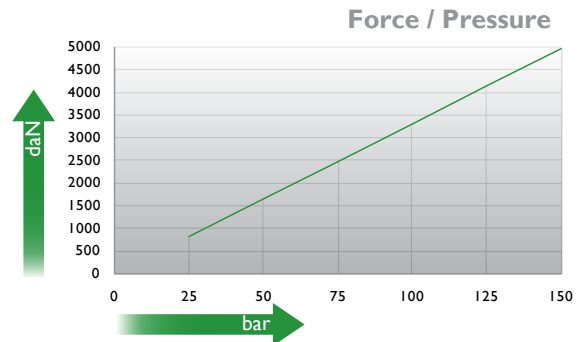
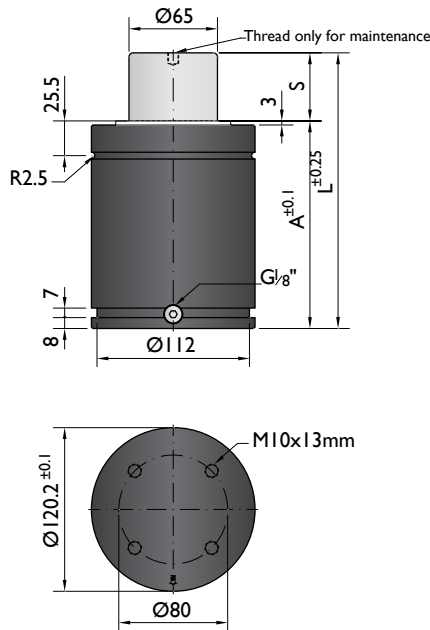

Ordering example: 4 x HG-5000-125

Order No.	S <sup>(1)</sup> mm	L mm	A mm	F <sub>0</sub> <sup>(2)</sup> daN (20°C, 150 bar)	F daN	(3)	kg
HG-5000-25	25	152.5	127.5		8000	No	9.04
HG-5000-38	37.5	177.5	140		8100	No	9.70
HG-5000-50	50	202.5	152.5		8200	No	10.35
HG-5000-63	62.5	227.5	165		8300	No	11.01
HG-5000-80	80	262.5	182.5	5000	8300	Yes	11.93
HG-5000-100	100	302.5	202.5		8400	Yes	12.98
HG-5000-125	125	352.5	227.5		8400	Yes	14.30
HG-5000-160	160	422.5	262.5		8400	Yes	16.14
HG-5000-200	200	502.5	302.5		8500	Yes	18.25

<sup>(1)</sup> other strokes under request

<sup>(2)</sup> alternative forces upon request

<sup>(3)</sup> ESK available for other strokes



Pressure medium	N <sub>2</sub>	Working temperature	0-80°C	Min. security stroke	10%
Max. Charging pressure	150 bar	Temperature related force increase	+0.34%/°C	Repair Kit	KIT HG-5000
Min. Charging pressure	25 bar	Max. working speed	1.6 m/s	Linkable	G1/8"

### Mounting possibilities

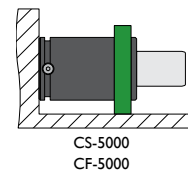
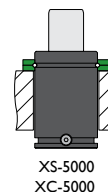
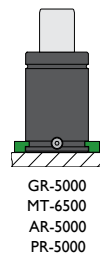
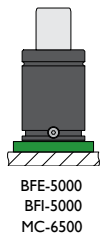
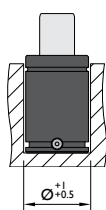
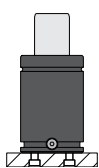

Flange must not support spring's force

## Flanges

**BFE-5000**

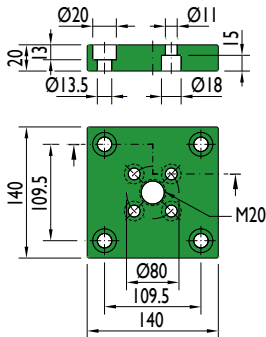

**BFI-5000**

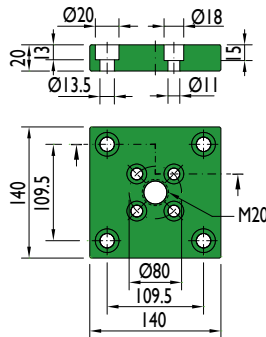

**MC-6500**

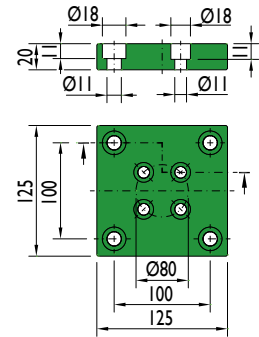

**GR-5000**

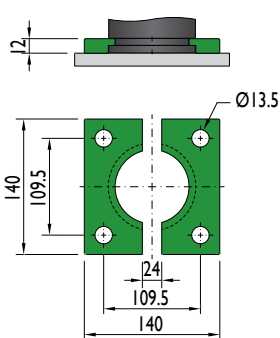

**MT-6500**

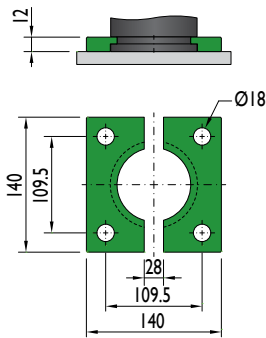

**AR-5000**

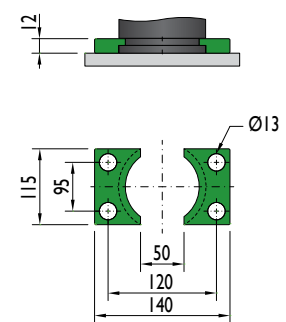

**XS-5000**

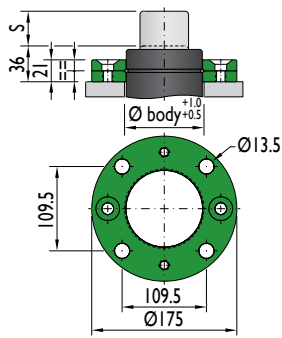

**XC-5000**

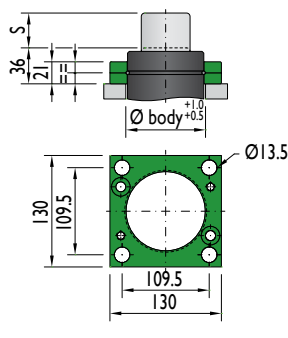

**PR-5000**

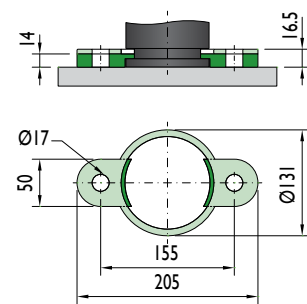

**CS-5000**

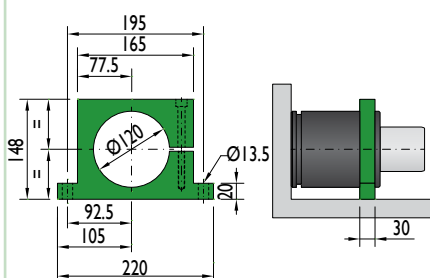

Flange must not support spring's force

**CF-5000**

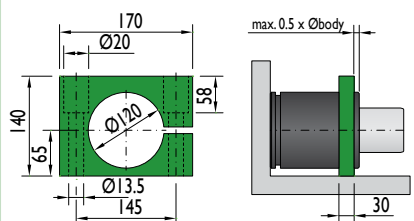

Flange must not support spring's force





CNOMO  
EM24.54.700

PSA  
E24.54.815.G

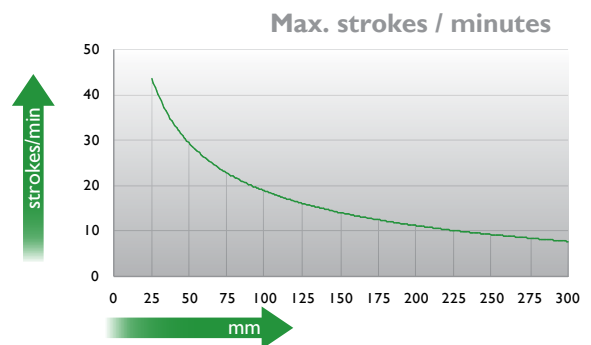
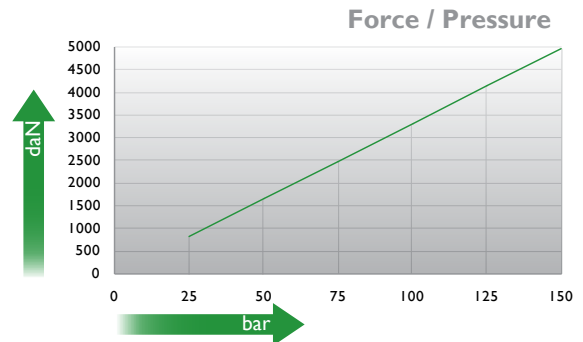
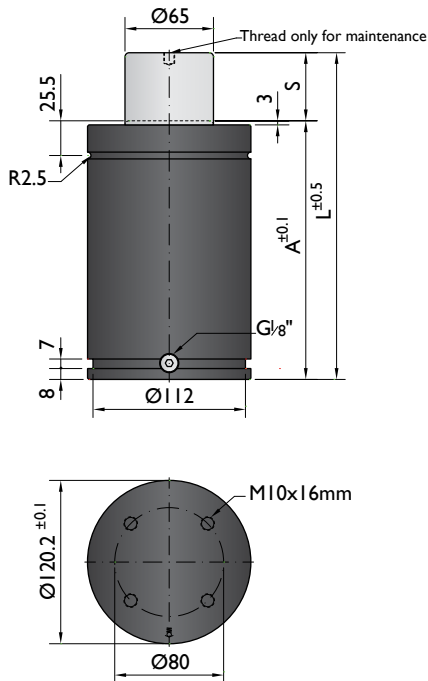

Ordering example: 4 x G-5000-125

Order No.	S <sup>(1)</sup> mm	L mm	A mm	F <sub>0</sub> <sup>(2)</sup> daN	F daN	 <sup>(3)</sup>	kg
				(20°C, 150 bar)			
G-5000-25	25	190	165	5000	5900	No	10.76
G-5000-38	38.1	216.2	178.1		6200	No	11.33
G-5000-50	50	240	190		6400	No	11.80
G-5000-63	63.5	267	203.5		6600	No	12.26
G-5000-80	80	300	220		6700	No	13.21
G-5000-100	100	340	240		7200	Yes	14.86
G-5000-125	125	390	265		7300	Yes	16.25
G-5000-160	160	460	300		7400	Yes	17.54
G-5000-200	200	540	340		7500	Yes	21.16
G-5000-250	250	640	390		7500	Yes	22.61
G-5000-300	300	740	440	7600	Yes	26.51	

<sup>(1)</sup> other strokes under request

<sup>(2)</sup> alternative forces upon request

<sup>(3)</sup> ESK available for other strokes



Pressure medium N<sub>2</sub>  
Max. Charging pressure 150 bar  
Min. Charging pressure 25 bar

Working temperature 0-80°C  
Temperature related force increase +0.34%/°C  
Max. working speed 1.6 m/s

Min. security stroke 10%  
Repair Kit KIT G-5000  
Linkable G1/8"

## Mounting possibilities

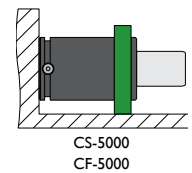
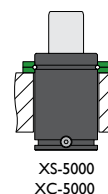
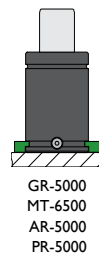
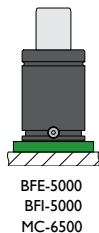
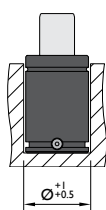
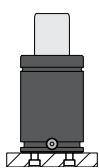

Flange must not support spring's force

## Flanges

**BFE-5000**

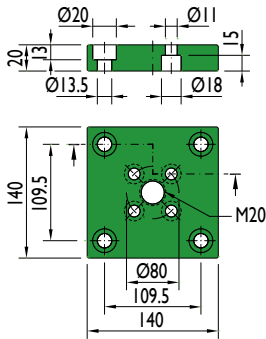

**BFI-5000**

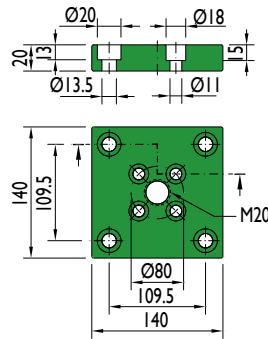

**MC-6500**

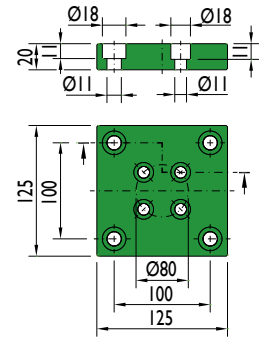

**GR-5000**

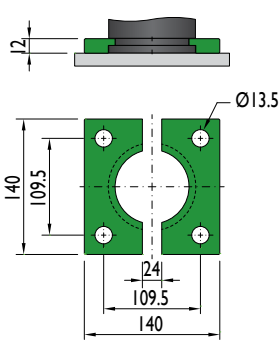

**MT-6500**

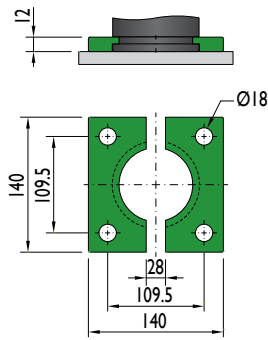

**AR-5000**

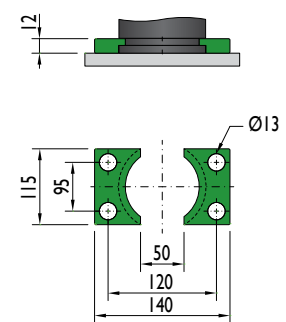

**XS-5000**

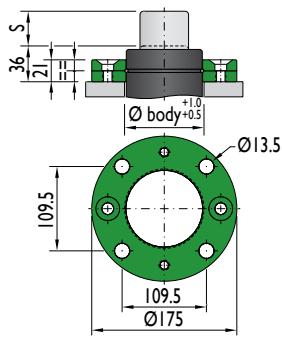

**XC-5000**

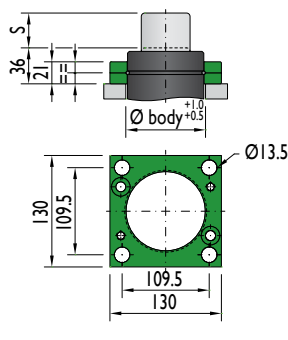

**PR-5000**

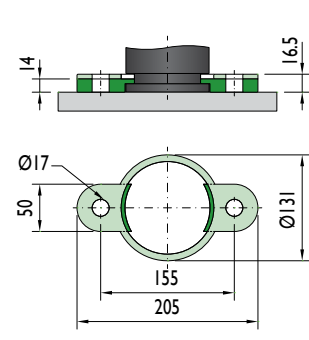

**CS-5000**

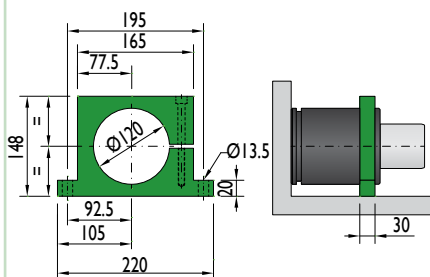

Flange must not support spring's force

**CF-5000**

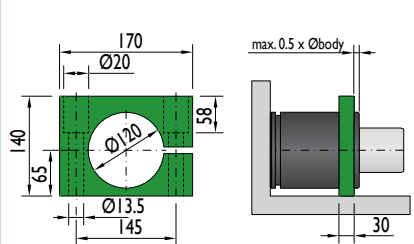

Flange must not support spring's force

Special mounts available on  
[www.nitrogas.com](http://www.nitrogas.com)



PSA  
E24.54.815.G

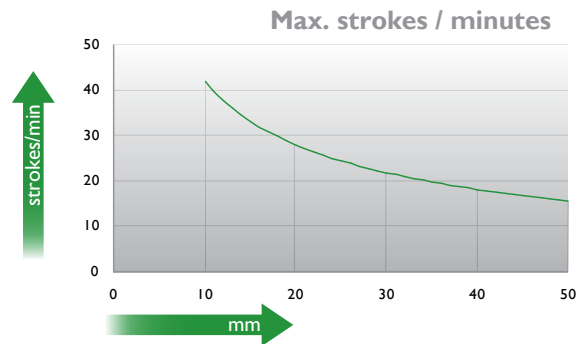
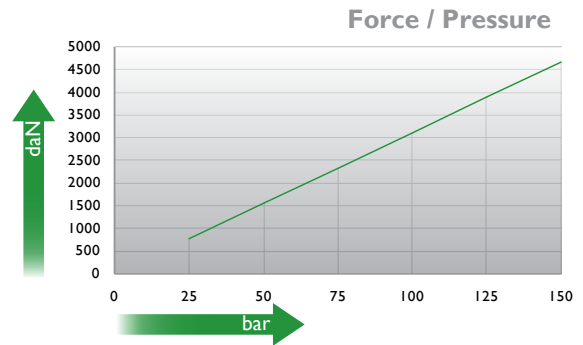
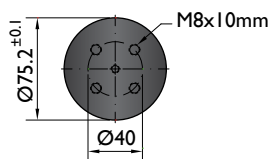
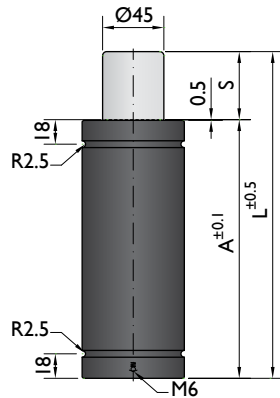

Ordering example: 4 x T-4700-50

Order No.	S <sup>(1)</sup> mm	L mm	A mm	F <sub>0</sub> <sup>(2)</sup> daN (20°C, 150 bar)	F daN	 <sup>(3)</sup>	kg
T-4700-10	10	80	70	4700	6800	No	1.55
T-4700-16	16	106	90		6800	No	1.80
T-4700-25	25	135	110		7000	No	2.07
T-4700-32	32	167	135		6800	No	2.38
T-4700-40	40	200	160		6800	No	2.72
T-4700-50	50	240	190		6800	No	3.14

<sup>(1)</sup> other strokes under request     
 <sup>(2)</sup> alternative forces upon request     
 <sup>(3)</sup> ESK under request



Pressure medium	N <sub>2</sub>	Working temperature	0-80°C	Min. security stroke	10%
Max. Charging pressure	150 bar	Temperature related force increase	+0.34%/°C	Repair Kit	KIT T-4700
Min. Charging pressure	25 bar	Max. working speed	0.5 m/s	Linkable	No

### Mounting possibilities

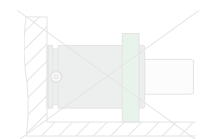
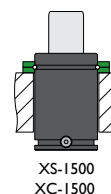
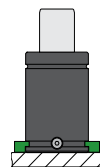
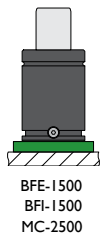
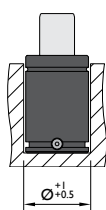
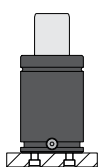

## Flanges

**BFE-1500**

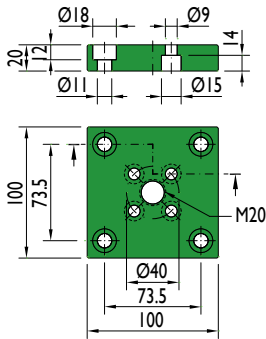

**BFI-1500**

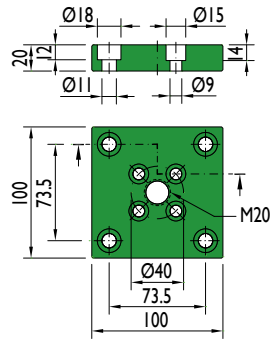

**MC-2500**

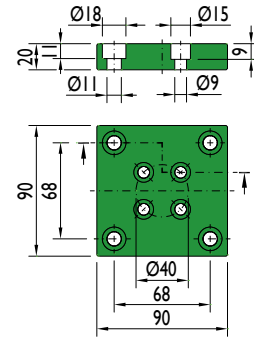

**XT-4700**

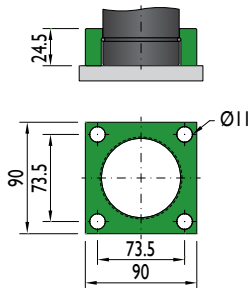

**XS-1500**

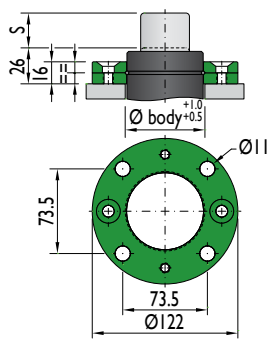

**XC-1500**

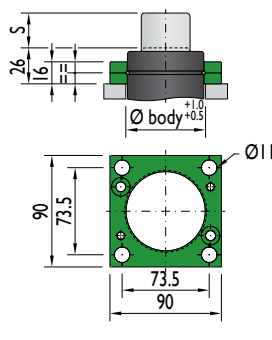

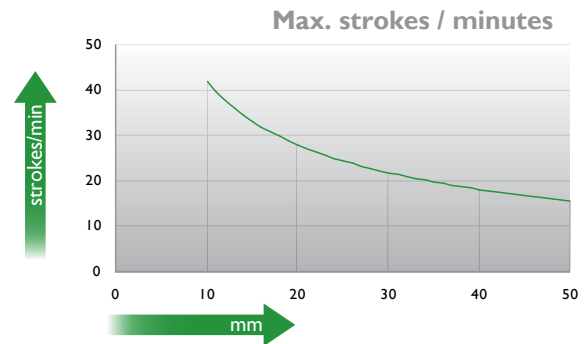
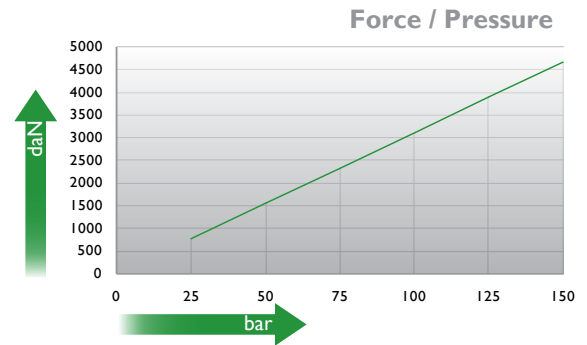
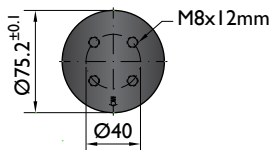
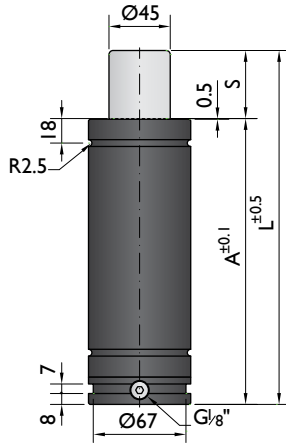

Ordering example: 4 x TC-4700-50

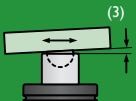
Order No.	S <sup>(1)</sup> mm	L mm	A mm	F <sub>0</sub> <sup>(2)</sup> daN (20°C, 150 bar)	F daN	 <sup>(3)</sup>	kg
TC-4700-10	10	100	90	4700	6800	No	2.11
TC-4700-16	16	126	110		6800	No	2.36
TC-4700-25	25	155	130		7000	No	2.63
TC-4700-32	32	187	155		6800	No	2.94
TC-4700-40	40	220	180		6800	No	3.28
TC-4700-50	50	260	210		6800	No	2.70

<sup>(1)</sup> other strokes under request     
 <sup>(2)</sup> alternative forces upon request     
 <sup>(3)</sup> ESK under request



Pressure medium	N <sub>2</sub>	Working temperature	0-80°C	Min. security stroke	10%
Max. Charging pressure	150 bar	Temperature related force increase	+0.34%/°C	Repair Kit	KIT TC-4700
Min. Charging pressure	25 bar	Max. working speed	0.5 m/s	Linkable	G1/8"

### Mounting possibilities

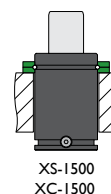
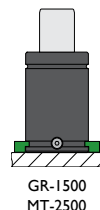
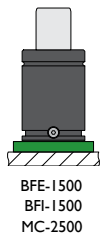
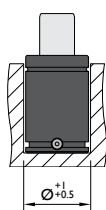
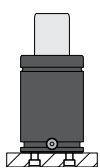

## Flanges

**BFE-1500**

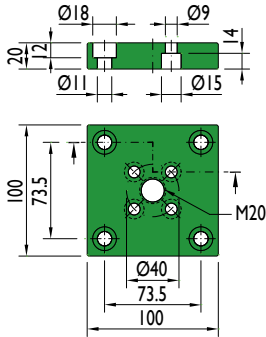

**BFI-1500**

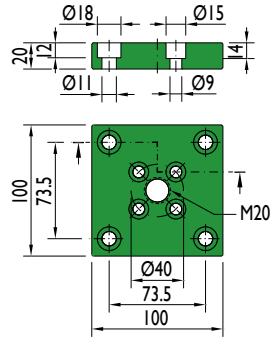

**MC-2500**

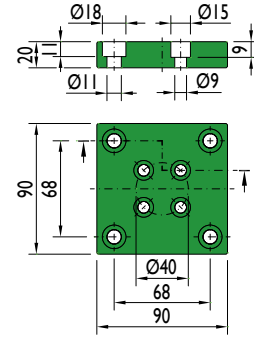

**GR-1500**

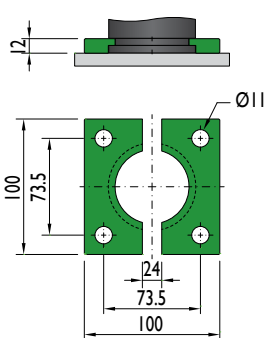

**MT-2500**

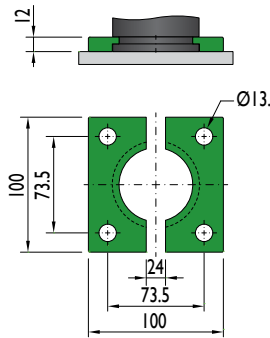

**XS-1500**

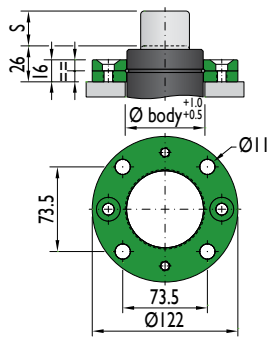

**XC-1500**

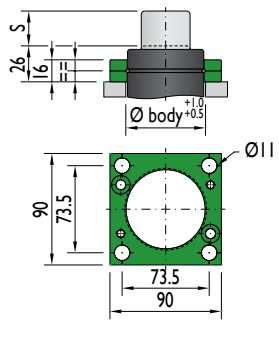

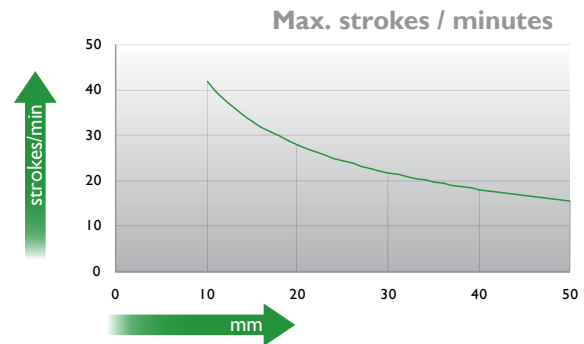
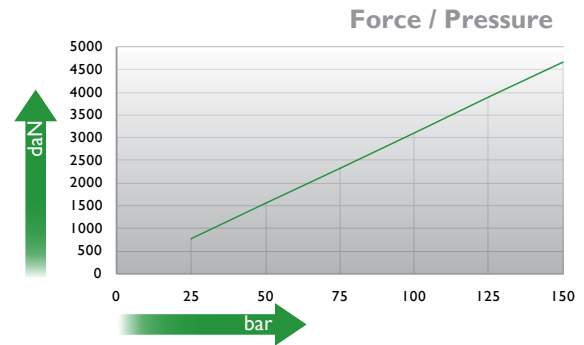
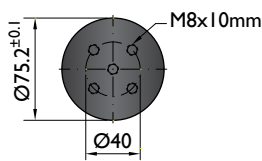
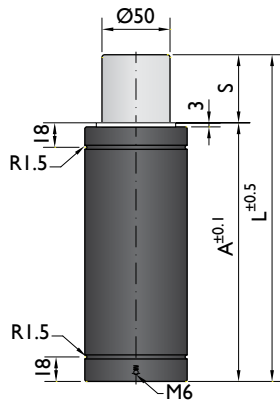

Ordering example: 4 x TS-4700-50

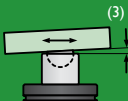
Order No.	S <sup>(1)</sup> mm	L mm	A mm	F <sub>0</sub> <sup>(2)</sup> daN (20°C, 150 bar)	F daN		kg
TS-4700-10	10	80	70	4700	6800	No	1.55
TS-4700-16	16	106	90		6800	No	1.80
TS-4700-25	25	135	110		7000	No	2.07
TS-4700-32	32	167	135		6800	No	2.38
TS-4700-40	40	200	160		6800	No	2.72
TS-4700-50	50	240	190		6800	No	3.14
TS-4700-65	65	273	208		7000	No	3.33

other strokes <sup>(1)</sup> under request

alternative forces <sup>(2)</sup> upon request

ESK <sup>(3)</sup> under request



Pressure medium	N <sub>2</sub>	Working temperature	0-80°C	Min. security stroke	10%
Max. Charging pressure	150 bar	Temperature related force increase	+0.34%/°C	Repair Kit	KIT TS-4700
Min. Charging pressure	25 bar	Max. working speed	0.5 m/s	Linkable	No

### Mounting possibilities

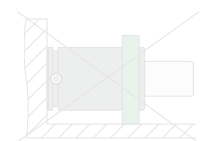
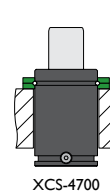
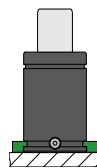
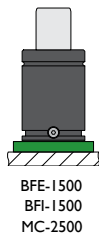
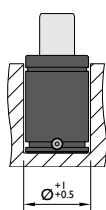
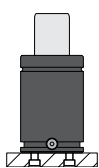

## Flanges

**BFE-1500**

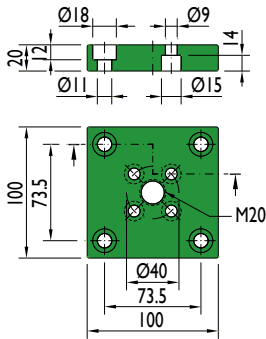

**BFI-1500**

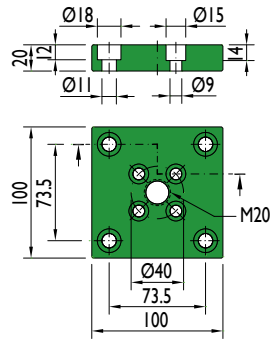

**MC-2500**

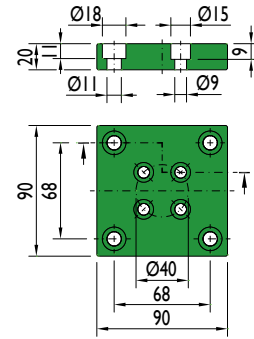

**XTS-4700**

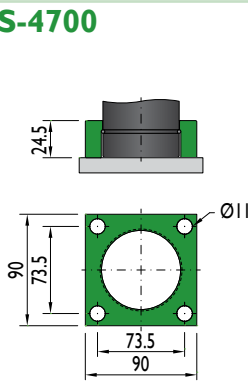

**XCS-4700**

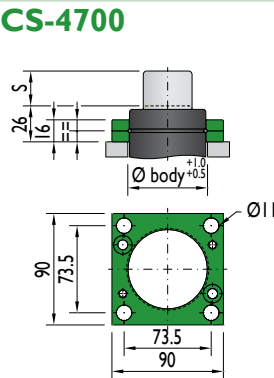



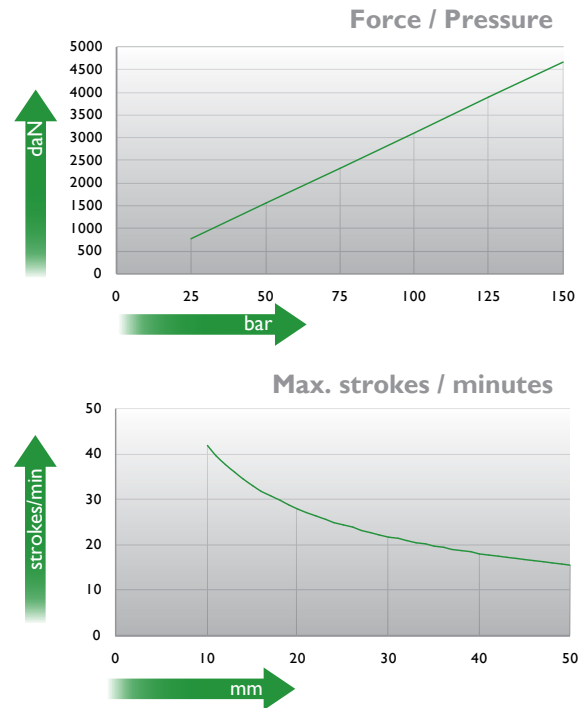
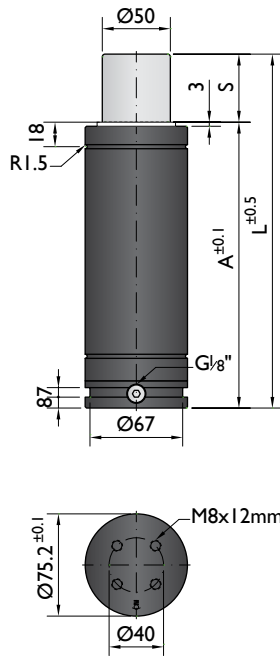

Ordering example: 4 x TSC-4700-65

Order No.	S <sup>(1)</sup> mm	L mm	A mm	F <sub>0</sub> <sup>(2)</sup> daN	F daN	(3)	kg
TSC-4700-10	10	100	90	4700	6800	No	2.11
TSC-4700-16	16	126	110		6800	No	2.36
TSC-4700-25	25	155	130		7000	No	2.63
TSC-4700-32	32	187	155		6800	No	2.94
TSC-4700-40	40	220	180		6800	No	3.28
TSC-4700-50	50	260	210		6800	No	2.70
TSC-4700-65	65	293	228		7000	No	3.98

other strokes <sup>(1)</sup> under request

alternative forces <sup>(2)</sup> upon request

ESK <sup>(3)</sup> under request



Pressure medium	N <sub>2</sub>	Working temperature	0-80°C	Min. security stroke	10%
Max. Charging pressure	150 bar	Temperature related force increase	+0.34%/°C	Repair Kit	KIT TSC-4700
Min. Charging pressure	25 bar	Max. working speed	0.5 m/s	Linkable	G1/8"

### Mounting possibilities

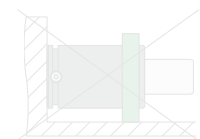
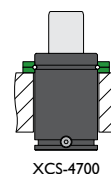
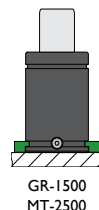
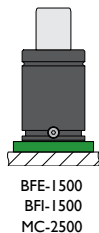
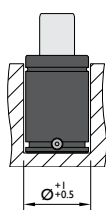
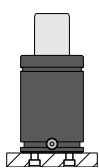

## Flanges

**BFE-1500**

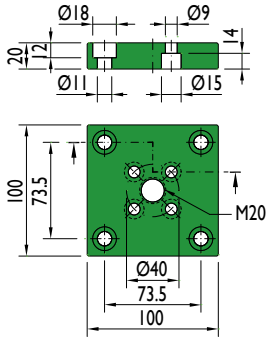

**BFI-1500**

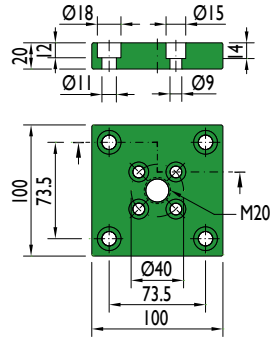

**MC-2500**

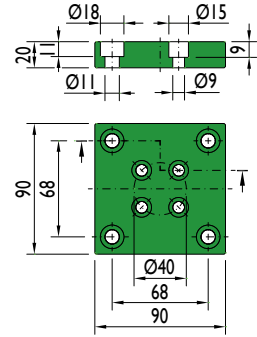

**GR-1500**

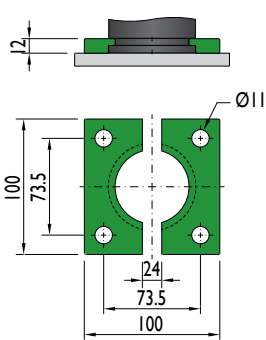

**MT-2500**

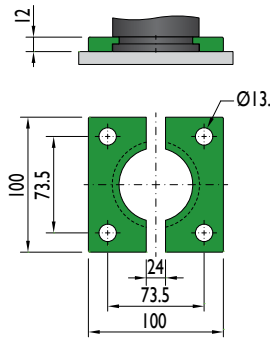

**XCS-4700**

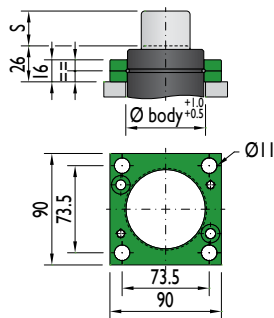

## Force 6500 daN

### Piston Rod Sealed gas springs

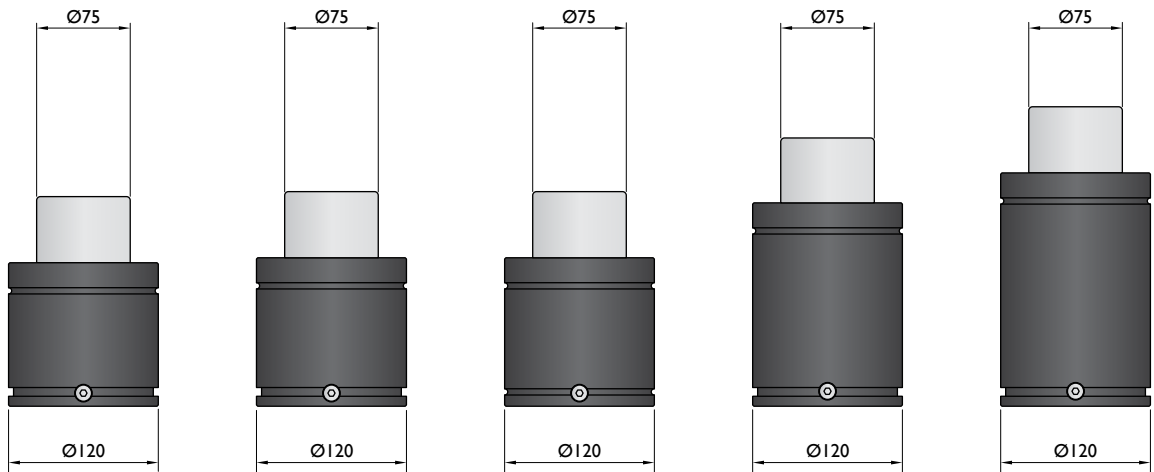
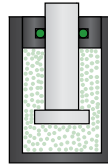

Model	KP-6600	NR-6600	NT-6600	M-6500	HD-6600
Initial F (daN)	6600	6600	6600	6400	6600
L max (mm)	2xStroke+68	2xStroke+72	2xStroke+72	2xStroke+115	2xStroke+140
Stroke (mm)	16-125	16-125	16-125	25-160	25-300

\* other strokes under request

### Standards

PED 97/23/EC	PED 97/23/EC	PED 97/23/EC	PED 97/23/EC	PED 97/23/EC
ISO 11901	ISO 11901	ISO 11901	ISO 11901	ISO 11901
VDI 3003	VDI 3003	VDI 3003	VDI 3003	VDI 3003
CNOMO EM24.54.700	CNOMO EM24.54.700	CNOMO EM24.54.700	CNOMO EM24.54.700	CNOMO EM24.54.700



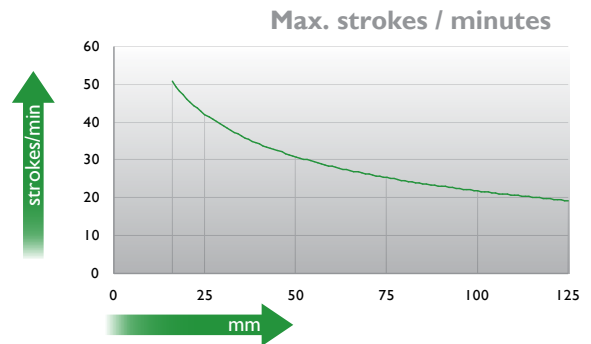
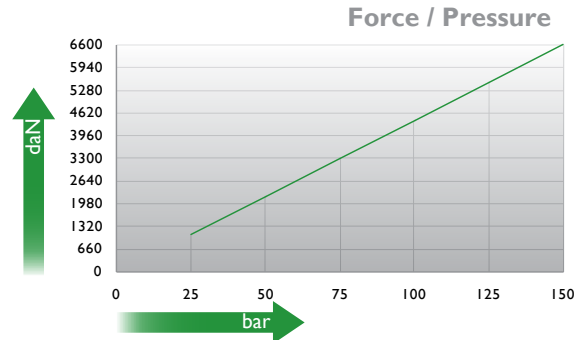
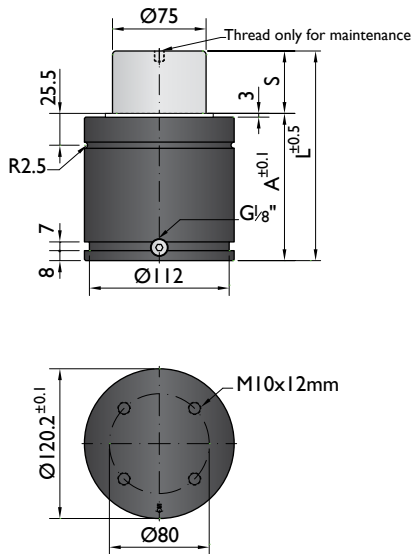

Ordering example: 4 x KP-6600-125

Order No.	S <sup>(1)</sup> mm	L mm	A mm	F <sub>0</sub> <sup>(2)</sup> daN (20°C, 150 bar)	F daN	 <sup>(3)</sup>	kg
KP-6600-16	16	100	84	6600	9800	No	5.85
KP-6600-19	19	106	87		10000	No	5.98
KP-6600-25	25	118	93		10300	No	6.24
KP-6600-32	32	132	100		10600	No	6.52
KP-6600-38	38	144	106		10700	No	6.79
KP-6600-50	50	168	118		11500	No	7.58
KP-6600-63	63	194	131		11500	Yes	8.07
KP-6600-75	75	218	143		11100	Yes	8.30
KP-6600-80	80	228	148		11100	Yes	8.46
KP-6600-100	100	268	168		11000	Yes	9.10
KP-6600-125	125	318	193		10900	Yes	9.89

<sup>(1)</sup> other strokes under request

<sup>(2)</sup> alternative forces upon request

<sup>(3)</sup> ESK available for other strokes



Pressure medium	N <sub>2</sub>	Working temperature	0-80°C	Min. security stroke	10%
Max. Charging pressure	150 bar	Temperature related force increase	+0.34%/°C	Repair Kit	KIT KP-6600
Min. Charging pressure	25 bar	Max. working speed	1.6 m/s	Linkable	G1/8"

## Mounting possibilities

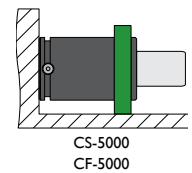
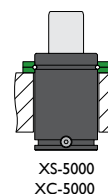
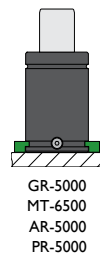
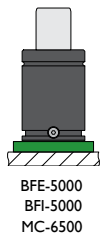
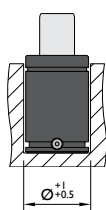
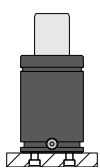

Flange must not support spring's force

## Flanges

**BFE-5000**

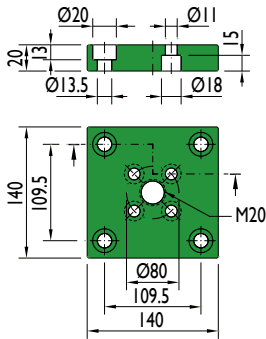

**BFI-5000**

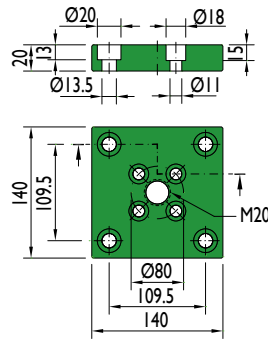

**MC-6500**

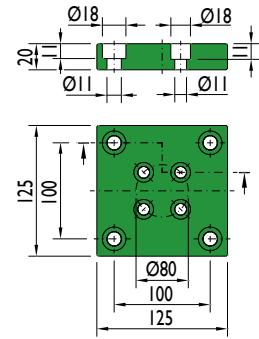

**GR-5000**

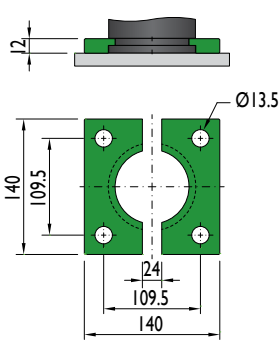

**MT-6500**

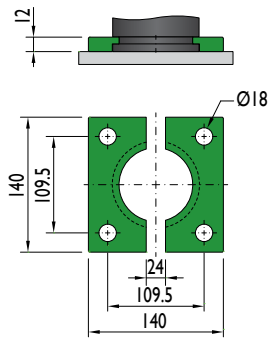

**AR-5000**

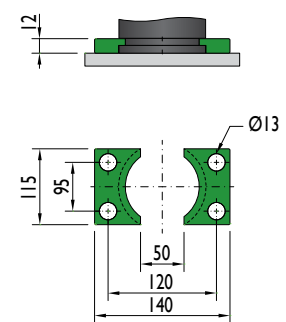

**XS-5000**

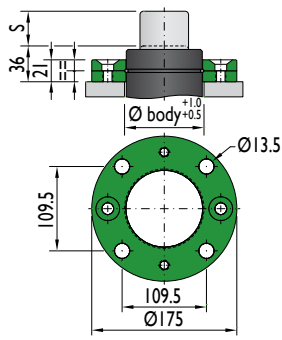

**XC-5000**

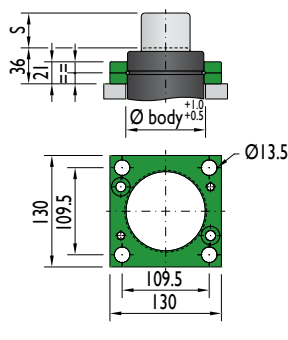

**PR-5000**

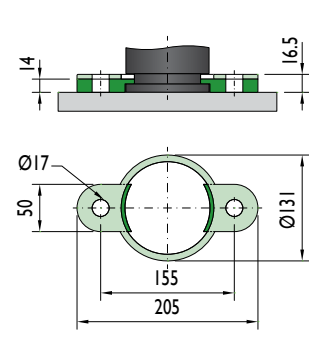

**CS-5000**

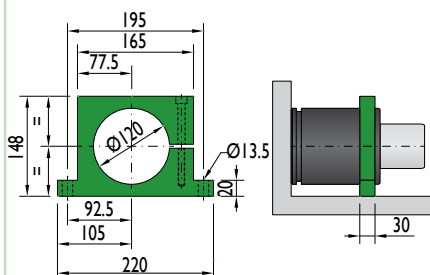

Flange must not support spring's force

**CF-5000**

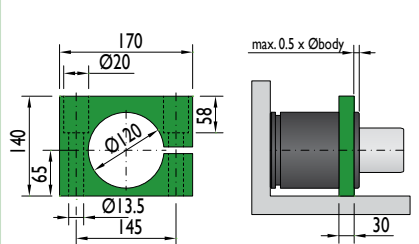

Flange must not support spring's force

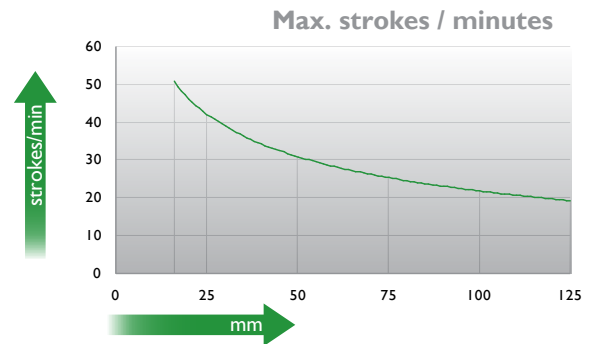
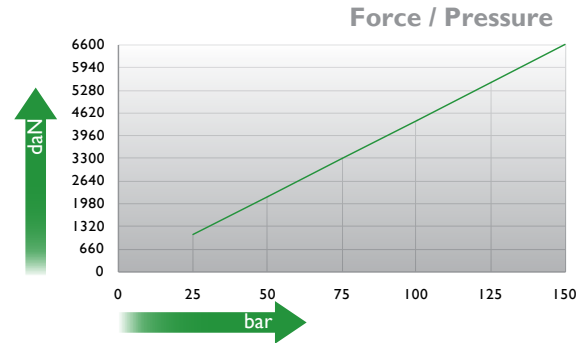
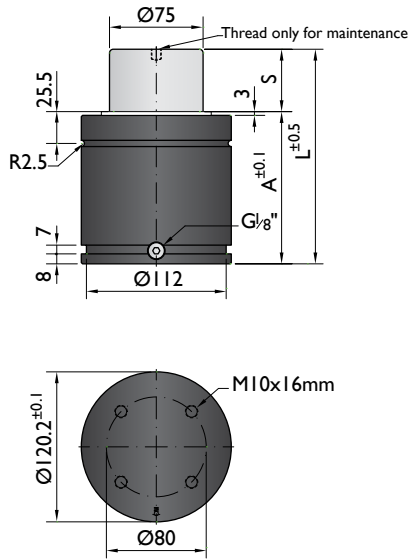

Ordering example: 4 x NR-6600-125

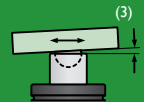
Order No.	S <sup>(1)</sup> mm	L mm	A mm	F <sub>0</sub> <sup>(2)</sup> daN (20°C, 150 bar)	F daN		kg
NR-6600-16	16	104	88	6600	8900	No	5.67
NR-6600-19	19	110	91		9100	No	5.81
NR-6600-25	25	122	97		9300	No	6.08
NR-6600-32	32	136	104		9600	No	6.41
NR-6600-38	38	148	110		9800	No	6.68
NR-6600-50	50	172	122		10000	No	7.21
NR-6600-63	63	198	135		10200	Yes	7.85
NR-6600-75	75	222	147		10300	Yes	7.31
NR-6600-80	80	232	152		10400	Yes	8.63
NR-6600-100	100	272	172		10500	Yes	9.56
NR-6600-125	125	322	197	10600	Yes	10.72	

<sup>(1)</sup> other strokes under request

<sup>(2)</sup> alternative forces upon request

<sup>(3)</sup> ESK available for other strokes



Pressure medium	N <sub>2</sub>	Working temperature	0-80°C	Min. security stroke	10%
Max. Charging pressure	150 bar	Temperature related force increase	+0.34%/°C	Repair Kit	KIT NR-6600
Min. Charging pressure	25 bar	Max. working speed	1.6 m/s	Linkable	G1/8"

### Mounting possibilities

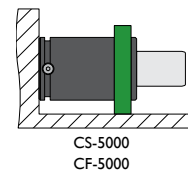
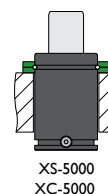
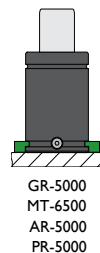
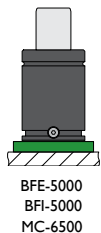
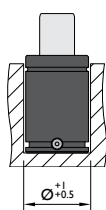
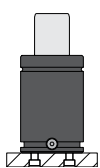

Flange must not support spring's force

## Flanges

**BFE-5000**

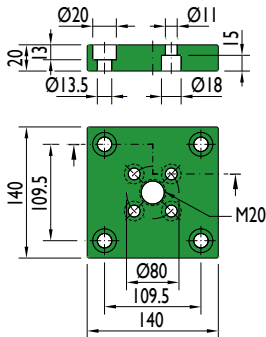

**BFI-5000**

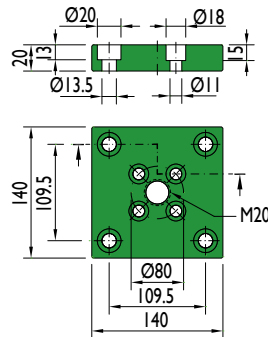

**MC-6500**

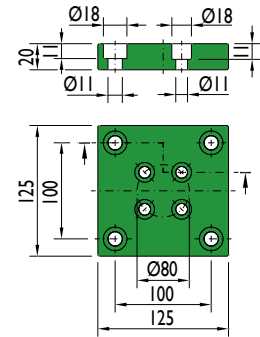

**GR-5000**

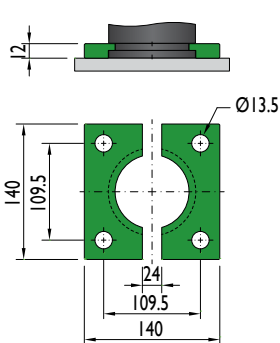

**MT-6500**

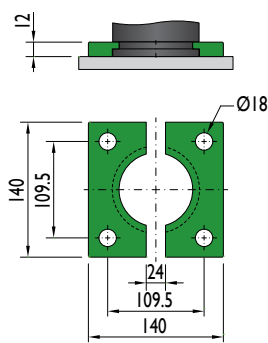

**AR-5000**

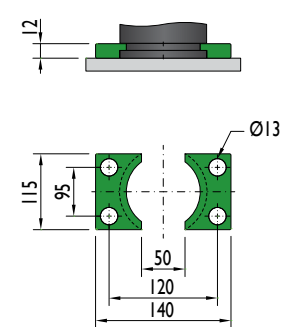

**XS-5000**

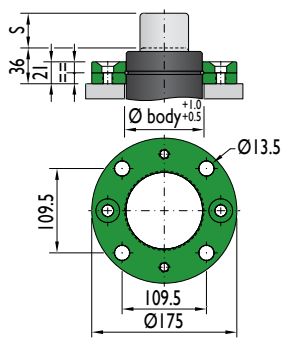

**XC-5000**

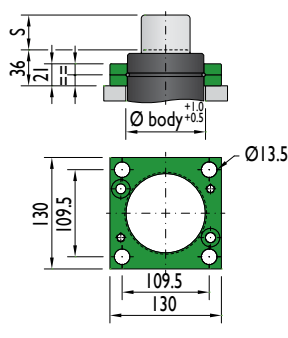

**PR-5000**

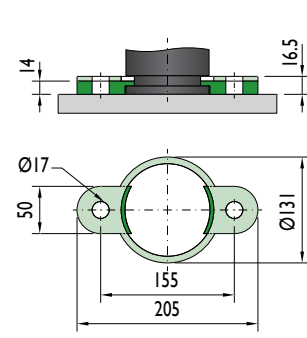

**CS-5000**

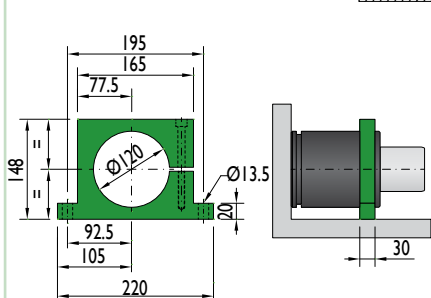

**CF-5000**

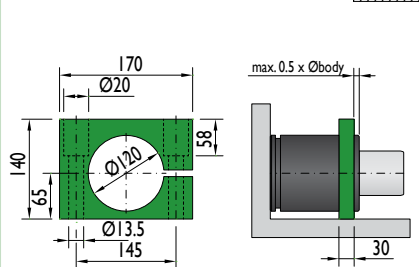

Flange must not support spring's force

Flange must not support spring's force



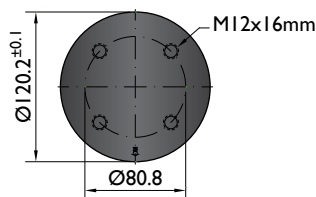
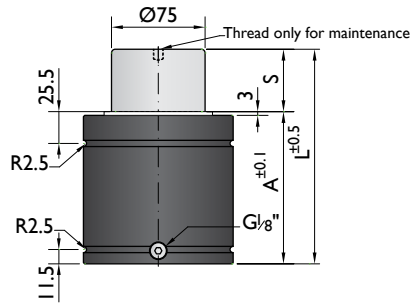

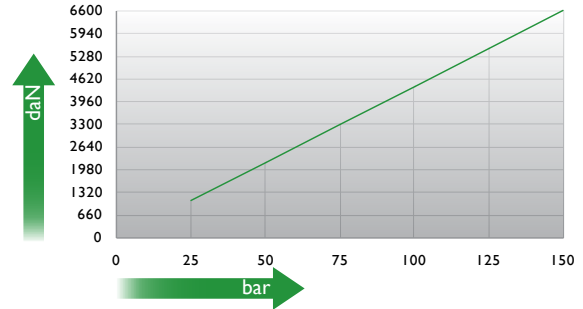

Force / Pressure

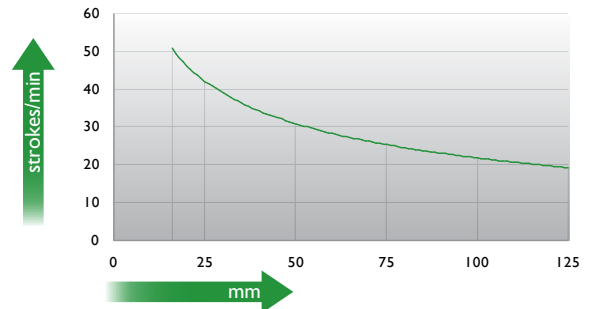

Max. strokes / minutes



Ordering example: 4 x NT-6600-125

Order No.	S <sup>(1)</sup> mm	L mm	A mm	F <sub>0</sub> <sup>(2)</sup> daN (20°C, 150 bar)	F daN	 <sup>(3)</sup>	kg
NT-6600-16	16	104	88	6600	8900	No	5.67
NT-6600-19	19	110	91		9100	No	5.81
NT-6600-25	25	122	97		9300	No	6.08
NT-6600-32	32	136	104		9600	No	6.41
NT-6600-38	38	148	110		9800	No	6.68
NT-6600-50	50	172	122		10000	No	7.21
NT-6600-63	63	198	135		10200	Yes	7.85
NT-6600-75	75	222	147		10300	Yes	7.31
NT-6600-80	80	232	152		10400	Yes	8.63
NT-6600-100	100	272	172		10500	Yes	9.56
NT-6600-125	125	322	197	10600	Yes	10.72	

<sup>(1)</sup> other strokes under request

<sup>(2)</sup> alternative forces upon request

<sup>(3)</sup> ESK available for other strokes



Pressure medium	N <sub>2</sub>	Working temperature	0-80°C	Min. security stroke	10%
Max. Charging pressure	150 bar	Temperature related force increase	+0.34%/°C	Repair Kit	KIT NT-6600
Min. Charging pressure	25 bar	Max. working speed	1.6 m/s	Linkable	G1/8"

## Mounting possibilities

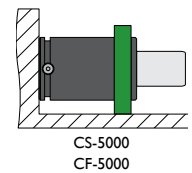
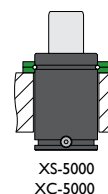
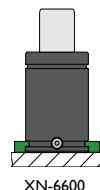
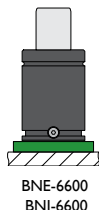
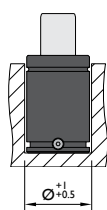
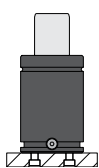

Flange must not support spring's force

## Flanges

**BNE-6600**

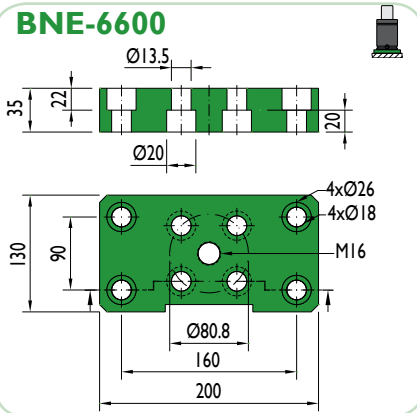

**BNI-6600**

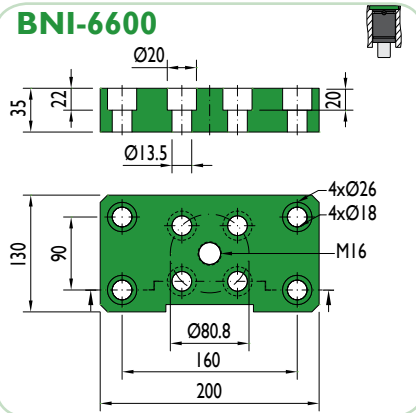

**XN-6600**

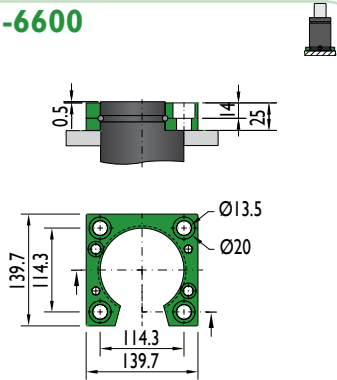

**XS-5000**

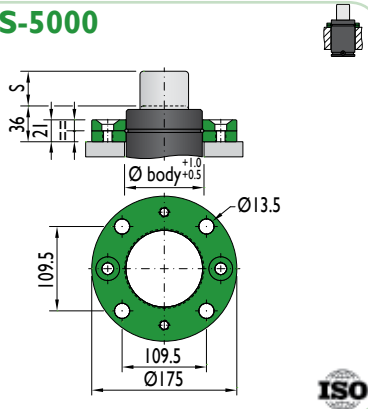

**XC-5000**

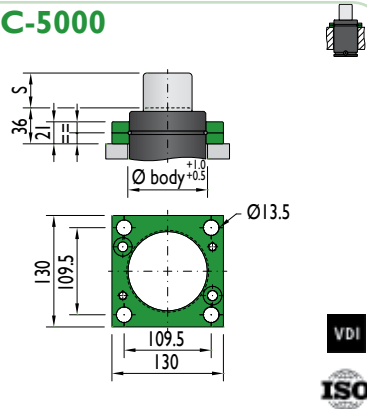

**CS-5000**

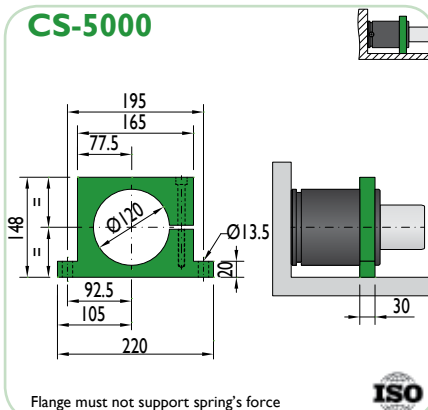

**CF-5000**

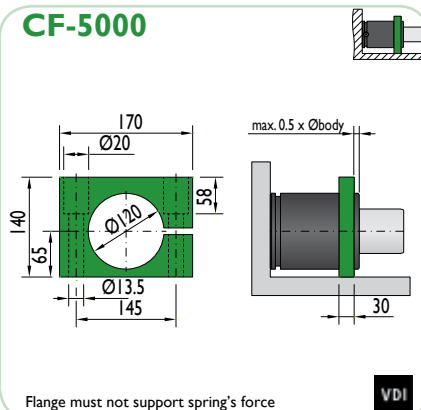



\*The new cylinder will be supplied when the stock runs out.

### NEW MODEL\*

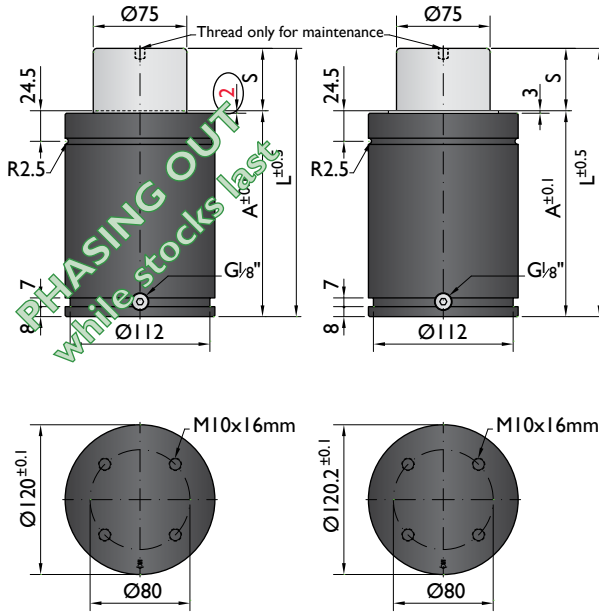

PHASING OUT  
while stocks last

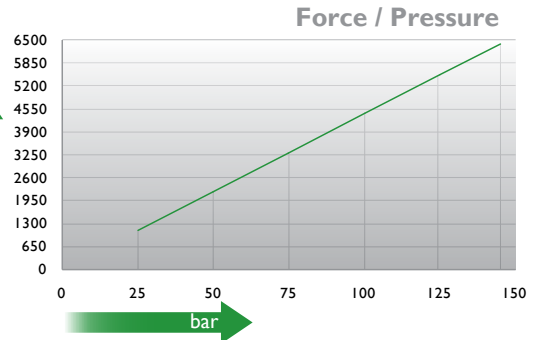

daN

bar

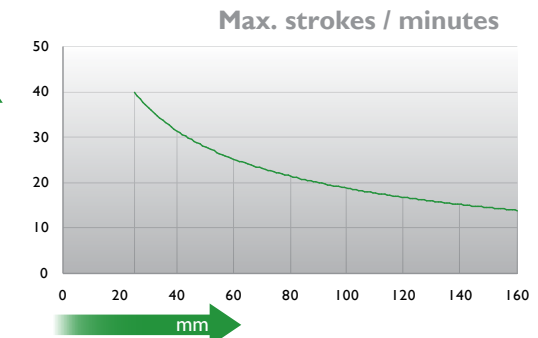

strokes/min

mm

Ordering example: 4 x M-6500-125

Order No.	S <sup>(1)</sup> mm	L mm	A mm	F <sub>0</sub> <sup>(2)</sup> daN (20°C, 145 bar)	F daN	<sup>(3)</sup>	kg
M-6500-25	25	165	140	6400	8900	No	9.18
M-6500-38	38	191	153		9400	No	9.72
M-6500-50	50	215	165		9800	No	10.40
M-6500-63	63	241	178		10000	No	10.36
M-6500-80	80	275	195		10500	No	11.61
M-6500-100	100	315	215		10900	Yes	12.42
M-6500-125	125	375	250		10600	Yes	13.43
M-6500-160	160	450	290		10700	Yes	14.84

other strokes <sup>(1)</sup> under request

alternative forces <sup>(2)</sup> upon request

ESK available for other strokes <sup>(3)</sup>



Pressure medium	N <sub>2</sub>	Working temperature	0-80°C	Min. security stroke	10%
Max. Charging pressure	145 bar	Temperature related force increase	+0.34%/°C	Repair Kit	KIT M-6500
Min. Charging pressure	25 bar	Max. working speed	1.6 m/s	Linkable	G1/8"

### Mounting possibilities

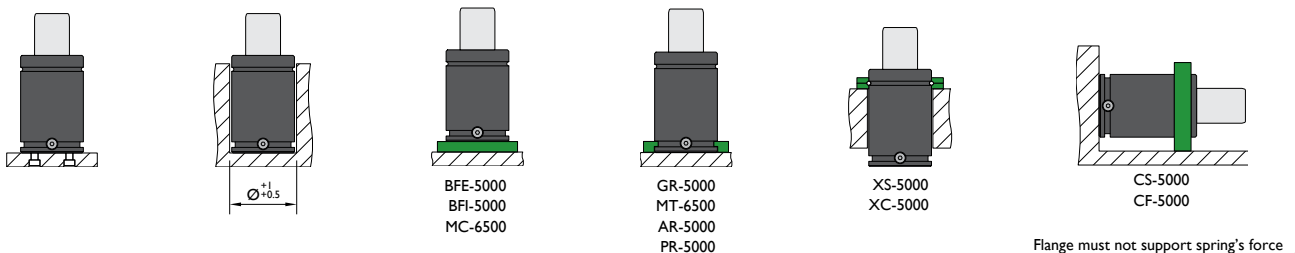

## Flanges

### BFE-5000

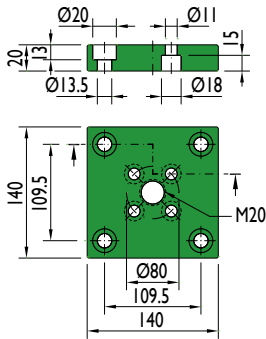

### BFI-5000

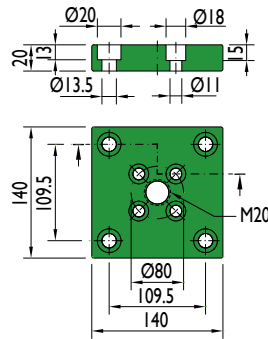

### MC-6500

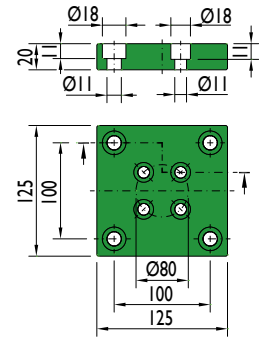

### GR-5000

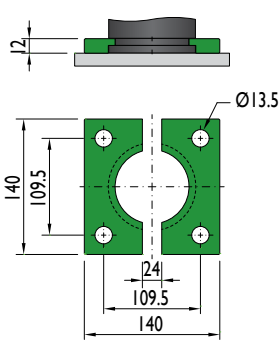

### MT-6500

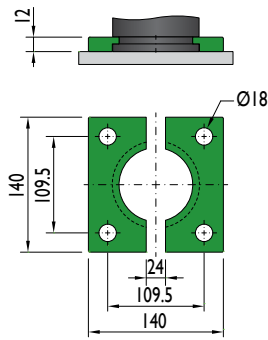

### AR-5000

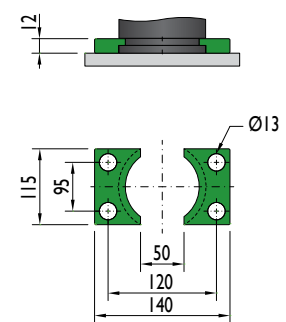

### XS-5000

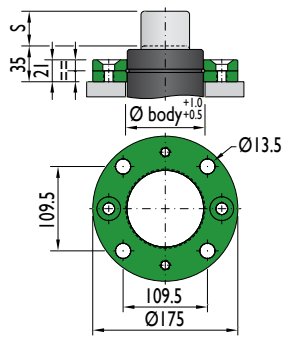

### XC-5000

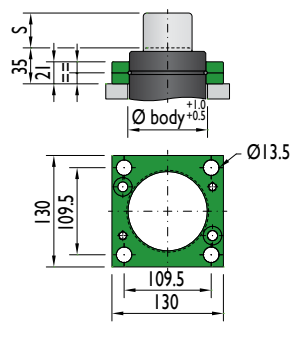

### PR-5000

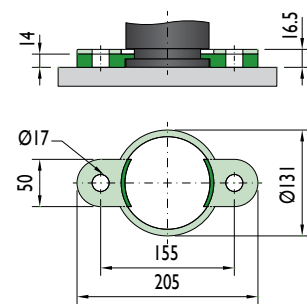

### CS-5000

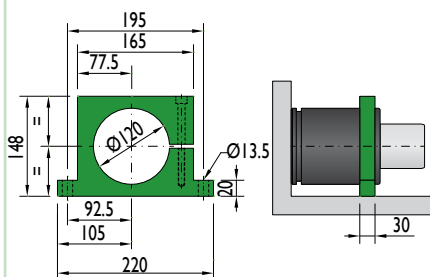

Flange must not support spring's force

### CF-5000

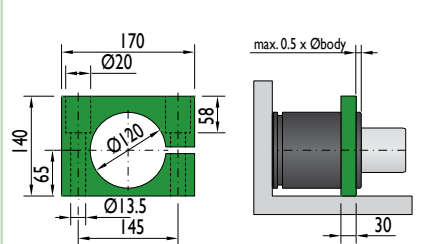

Flange must not support spring's force

Special mounts available on  
[www.nitrogas.com](http://www.nitrogas.com)

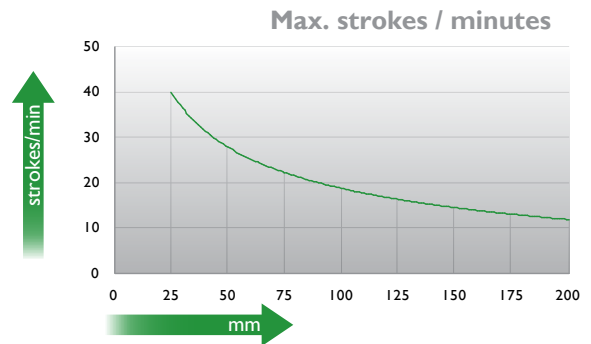
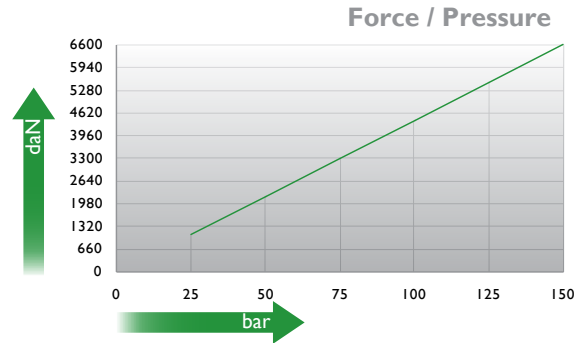
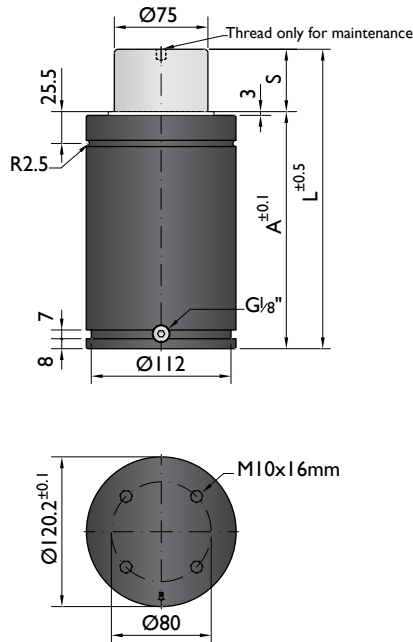

Ordering example: 4 x HD-6600-125

Order No.	S <sup>(1)</sup> mm	L mm	A mm	F <sub>0</sub> <sup>(2)</sup> daN	F daN	 <sup>(3)</sup>	kg
				(20°C, 150 bar)			
HD-6600-25	25	190	165	6600	8100	No	13.35
HD-6600-38	38	216	178		8600	No	14.62
HD-6600-50	50	240	190		9000	No	16.55
HD-6600-63	63	266	203		9300	No	17.85
HD-6600-80	80	300	220		10000	No	18.63
HD-6600-100	100	340	240		10300	Yes	19.32
HD-6600-125	125	390	265		10600	Yes	19.95
HD-6600-160	160	460	300		10900	Yes	20.81
HD-6600-200	200	540	340		11200	Yes	21.55
HD-6600-250	250	640	390		11500	Yes	23.58
HD-6600-300	300	740	440	11800	Yes	25.61	

<sup>(1)</sup> other strokes under request

<sup>(2)</sup> alternative forces upon request

<sup>(3)</sup> ESK available for other strokes



Pressure medium	N <sub>2</sub>	Working temperature	0-80°C	Min. security stroke	10%
Max. Charging pressure	150 bar	Temperature related force increase	+0.34%/°C	Repair Kit	KIT HD-6600
Min. Charging pressure	25 bar	Max. working speed	1.6 m/s	Linkable	G1/8"

### Mounting possibilities

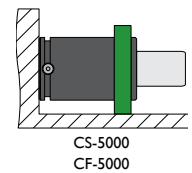
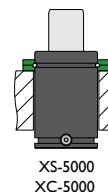
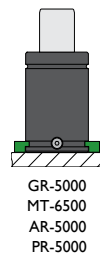
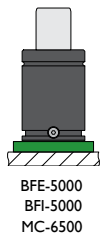
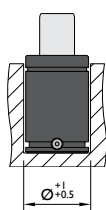
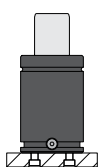

Flange must not support spring's force

## Flanges

**BFE-5000**

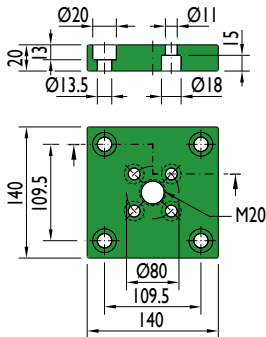

**BFI-5000**

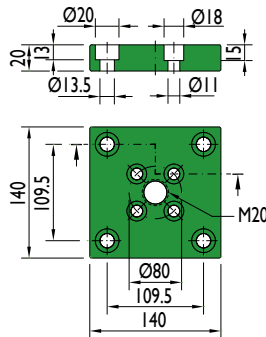

**MC-6500**

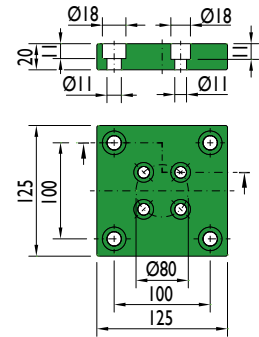

**GR-5000**

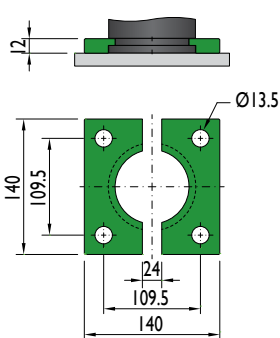

**MT-6500**

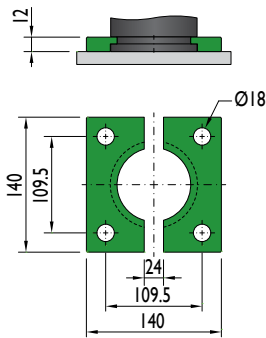

**AR-5000**

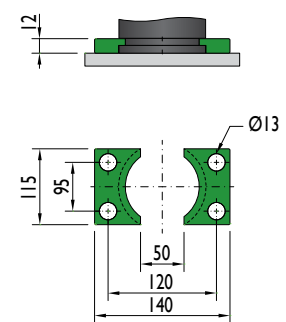

**XS-5000**

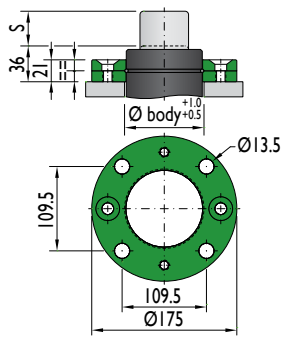

**XC-5000**

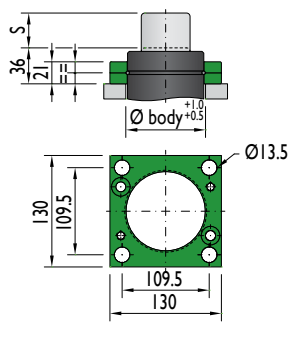

**PR-5000**

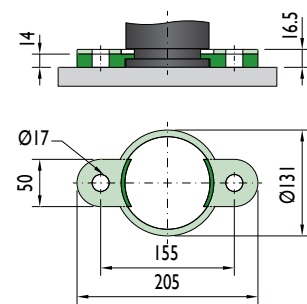

**CS-5000**

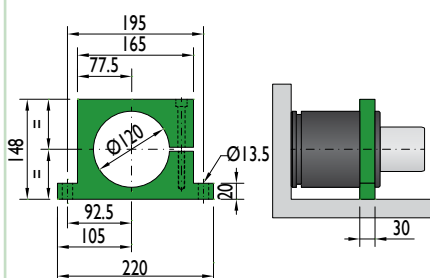

Flange must not support spring's force

**CF-5000**

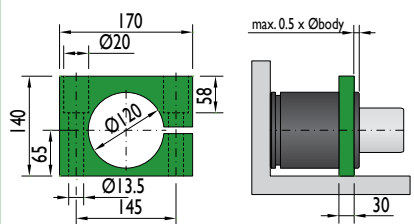

Flange must not support spring's force

## Force 7500 daN

### Piston Rod Sealed gas springs

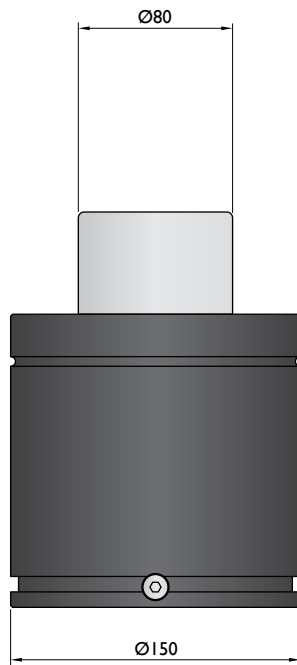
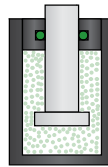

**HG-7500**

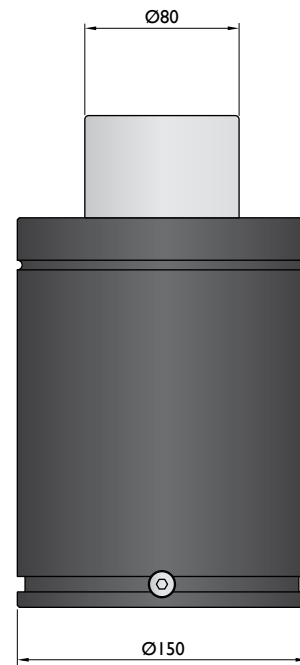

**CN-7500**

**Model**  
**Initial F**  
(daN)  
**L max**  
(mm)  
**Stroke**  
(mm)

7500  
2xStroke+105  
25-200

7500  
2xStroke+155  
25-300

\* other strokes under request

**Standards**

**PED**  
97/23/EC

**ISO**  
11901

**VDI**  
3003

**CNOMO**  
EM24.54.700

**PED**  
97/23/EC

**ISO**  
11901

**VDI**  
3003

**CNOMO**  
EM24.54.700

## Force 7500 daN

Bore Sealed  
gas springs

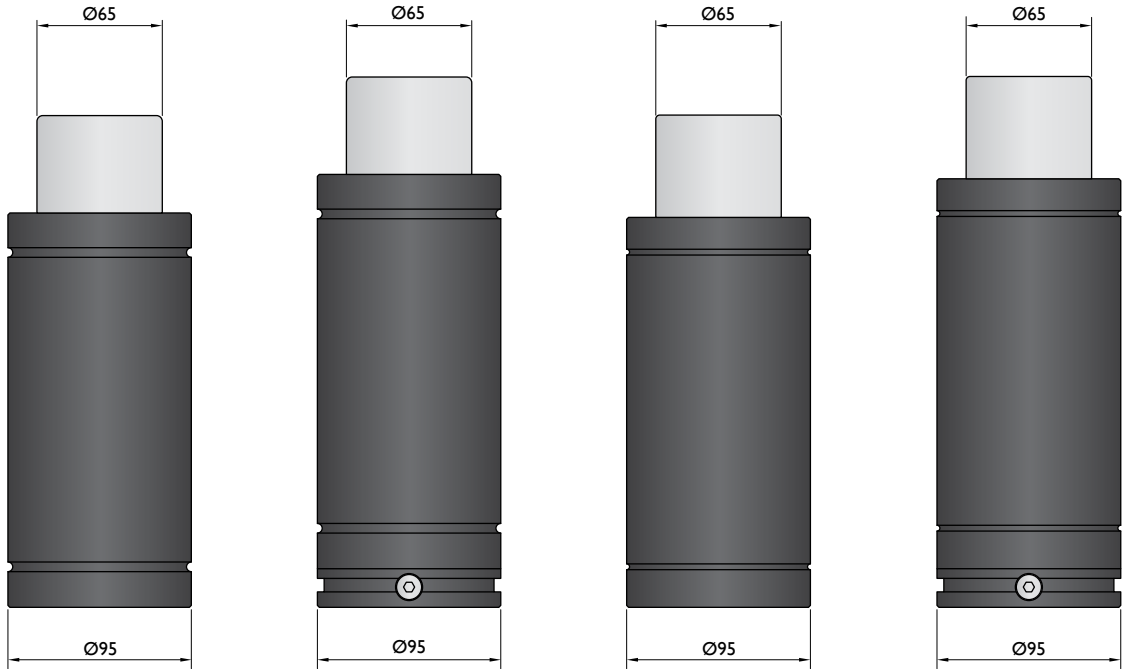
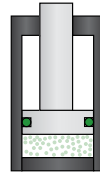

Model	T-7500	TC-7500	TS-7500	TSC-7500
Initial F (daN)	7500	7500	7500	7500
L max (mm)	90-255	110-275	90-279	110-299
Stroke (mm)	10-50	10-50	10-65	10-65

\* other strokes under request

Standards

PED  
97/23/EC

ISO  
11901

VDI  
3003

CNOMO  
EM24.54.700

PED  
97/23/EC

ISO  
11901

VDI  
3003

CNOMO  
EM24.54.700

PED  
97/23/EC

ISO  
11901

VDI  
3003

CNOMO  
EM24.54.700

PED  
97/23/EC

ISO  
11901

VDI  
3003

CNOMO  
EM24.54.700



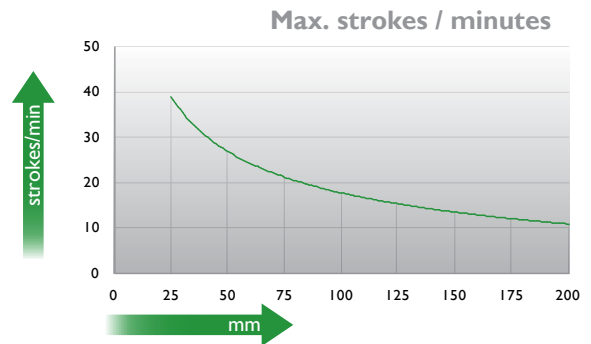
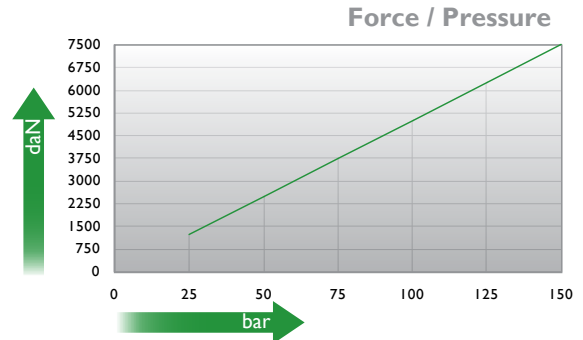
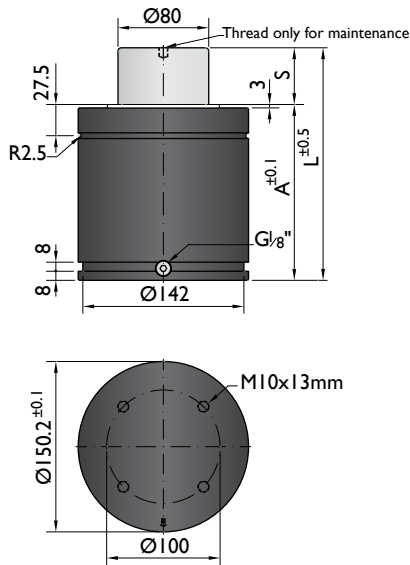

Ordering example: 4 x HG-7500-125

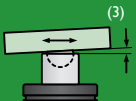
Order No.	S <sup>(1)</sup> mm	L mm	A mm	F <sub>0</sub> <sup>(2)</sup> daN (20°C, 150 bar)	F daN	 <sup>(3)</sup>	kg
HG-7500-25	25	155	130		9900	No	13.6
HG-7500-38	37.5	180	142.5		10400	No	14.5
HG-7500-50	50	205	155		10600	No	15.4
HG-7500-63	62.5	230	167.5		10800	No	16.3
HG-7500-80	80	265	185	7500	11500	No	17.5
HG-7500-100	100	305	205		11200	Yes	18.9
HG-7500-125	125	355	230		11300	Yes	20.7
HG-7500-160	160	425	265		11400	Yes	23.2
HG-7500-200	200	505	305		11500	Yes	26.1

<sup>(1)</sup> other strokes under request

<sup>(2)</sup> alternative forces upon request

<sup>(3)</sup> ESK available for other strokes



Pressure medium	N <sub>2</sub>	Working temperature	0-80°C	Min. security stroke	10%
Max. Charging pressure	150 bar	Temperature related force increase	+0.34%/°C	Repair Kit	KIT HG-7500
Min. Charging pressure	25 bar	Max. working speed	1.6 m/s	Linkable	G1/8"

### Mounting possibilities

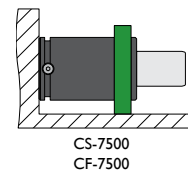
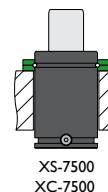
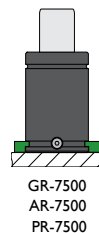
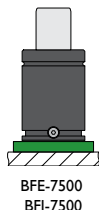
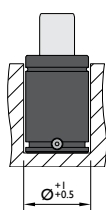
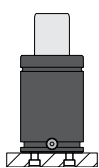

Flange must not support spring's force

## Flanges

**BFE-7500**

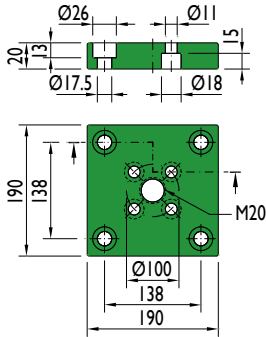

**BFI-7500**

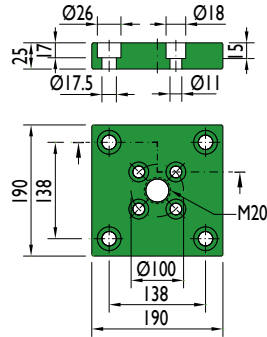

**GR-7500**

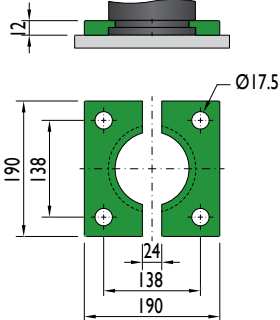

**AR-7500**

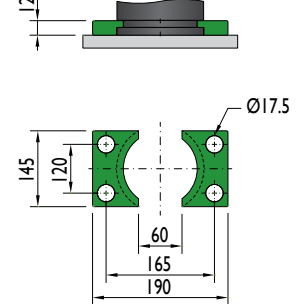

**XS-7500**

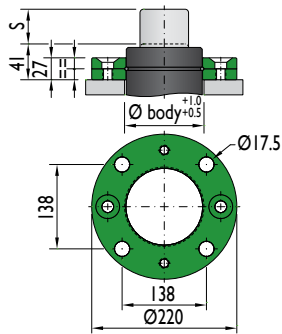

**XC-7500**

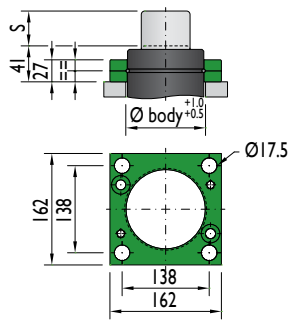

**PR-7500**

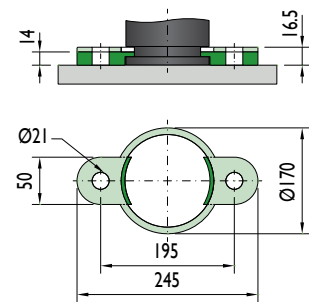

**CS-7500**

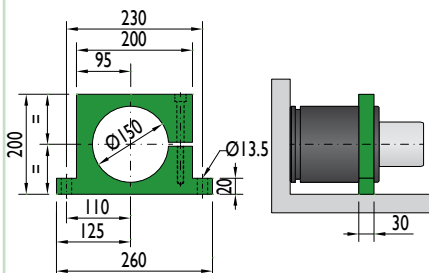

Flange must not support spring's force

**CF-7500**

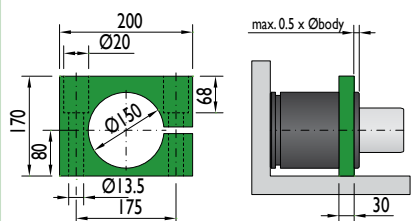

Flange must not support spring's force



CNOMO  
EM24.54.700

PSA  
E24.54.815.G

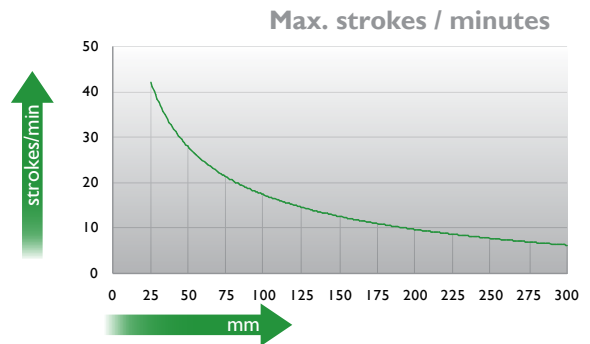
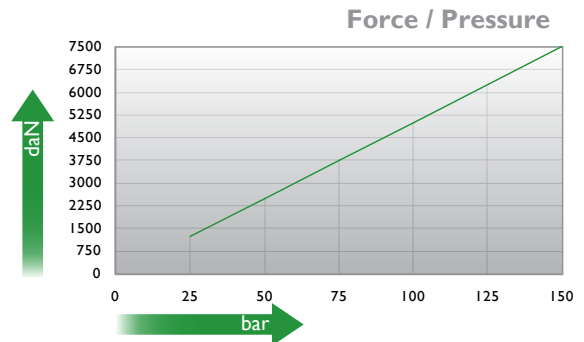
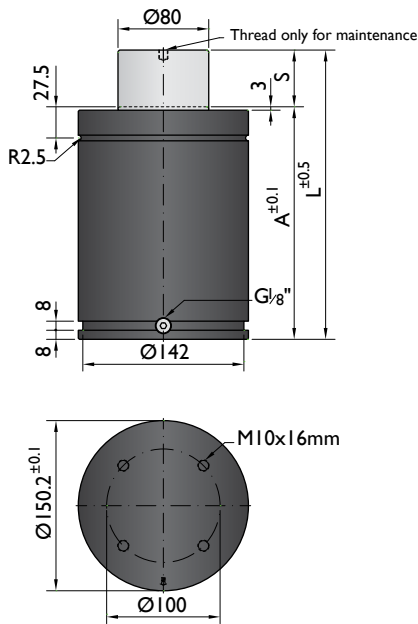

Ordering example: 4 x CN-7500-125

Order No.	S <sup>(1)</sup> mm	L mm	A mm	F <sub>0</sub> <sup>(2)</sup> daN (20°C, 150 bar)	F daN	 <sup>(3)</sup>	kg
CN-7500-25	25	205	180	7500	9000	No	18.06
CN-7500-38	38.1	231.2	193.1		9400	No	18.93
CN-7500-50	50	255	205		9700	No	20.30
CN-7500-63	63.5	282	218.5		9900	No	21.08
CN-7500-80	80	315	235		10100	No	22.21
CN-7500-100	100	355	255		10500	Yes	23.47
CN-7500-125	125	405	280		10700	Yes	24.96
CN-7500-160	160	475	315		10900	Yes	27.01
CN-7500-200	200	555	355		11100	Yes	29.81
CN-7500-250	250	655	405		11200	Yes	33.01
CN-7500-300	300	755	455		11300	Yes	36.11

<sup>(1)</sup> other strokes under request

<sup>(2)</sup> alternative forces upon request

<sup>(3)</sup> ESK available for other strokes



Pressure medium	N <sub>2</sub>	Working temperature	0-80°C	Min. security stroke	10%
Max. Charging pressure	150 bar	Temperature related force increase	+0.34%/°C	Repair Kit	KIT CN-7500
Min. Charging pressure	25 bar	Max. working speed	1.6 m/s	Linkable	G1/8"

## Mounting possibilities

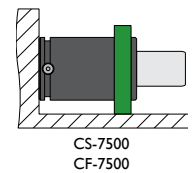
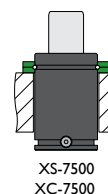
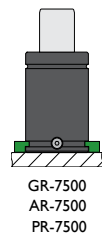
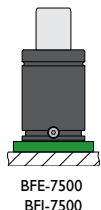
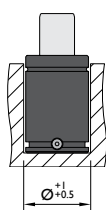
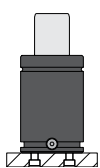

Flange must not support spring's force

## Flanges

**BFE-7500**

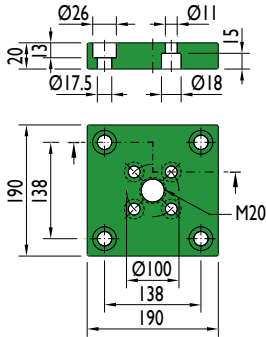

**BFI-7500**

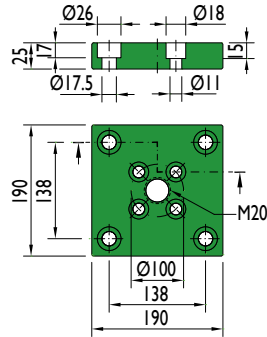

**GR-7500**

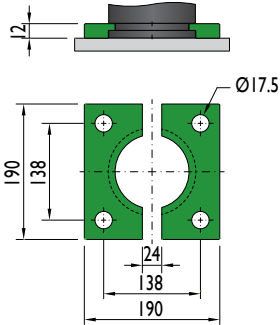

**AR-7500**

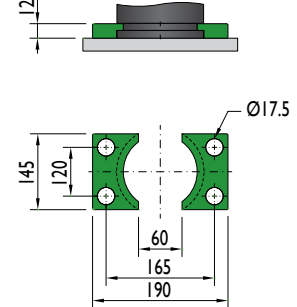

**XS-7500**

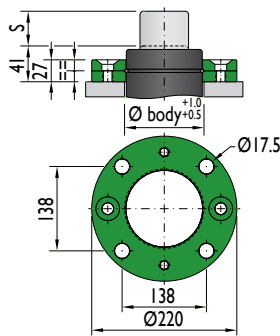

**XC-7500**

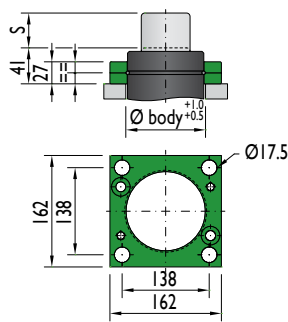

**PR-7500**

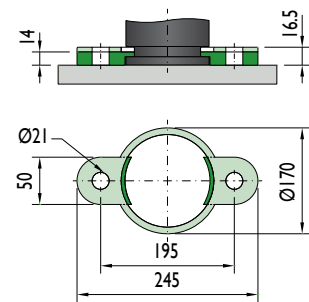

**CS-7500**

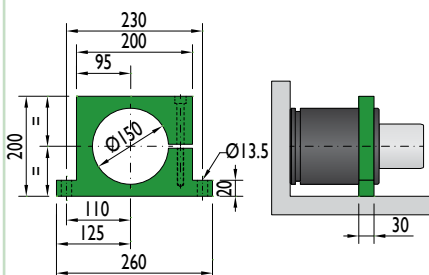

Flange must not support spring's force

**CF-7500**

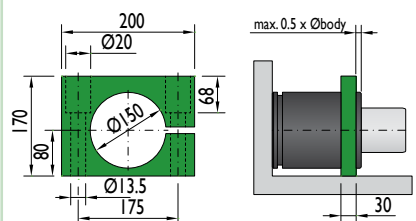

Flange must not support spring's force

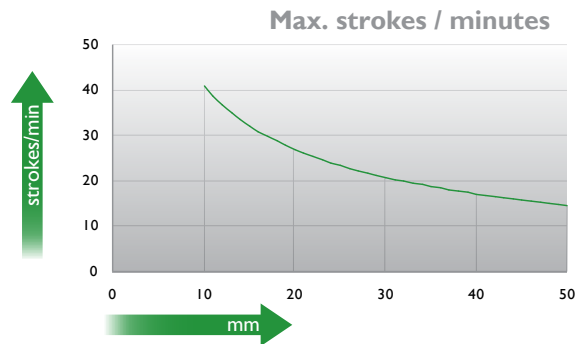
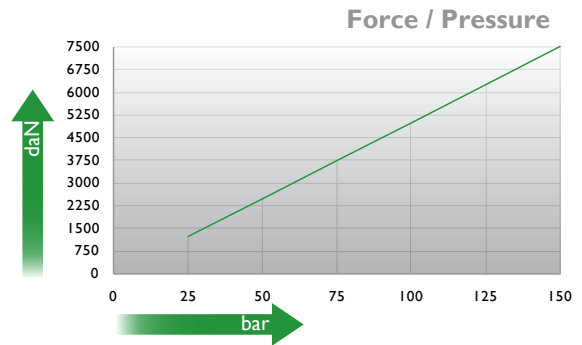
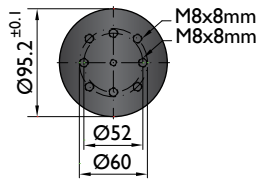
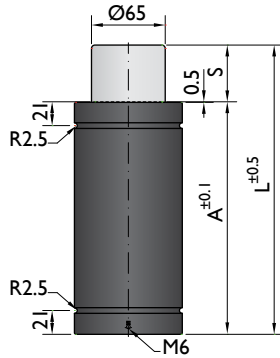

Ordering example: 4 x T-7500-50

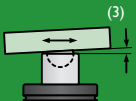
Order No.	S <sup>(1)</sup> mm	L mm	A mm	F <sub>0</sub> <sup>(2)</sup> daN (20°C, 150 bar)	F daN	 <sup>(3)</sup>	kg
T-7500-10	10	90	80	7500	11100	No	2.52
T-7500-16	16	116	100		9900	No	3.03
T-7500-25	25	145	120		10400	No	3.83
T-7500-32	32	182	150		10400	No	3.90
T-7500-40	40	210	170		10400	No	4.03
T-7500-50	50	255	205		10400	No	4.14

<sup>(1)</sup> other strokes under request     
 <sup>(2)</sup> alternative forces upon request     
 <sup>(3)</sup> ESK under request



Pressure medium	N <sub>2</sub>	Working temperature	0-80°C	Min. security stroke	10%
Max. Charging pressure	150 bar	Temperature related force increase	+0.34%/°C	Repair Kit	KIT T-7500
Min. Charging pressure	25 bar	Max. working speed	0.5 m/s	Linkable	No

### Mounting possibilities

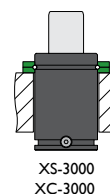
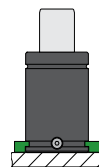
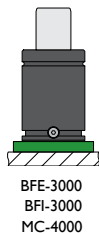
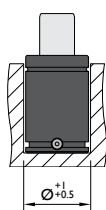
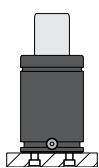

## Flanges

**BFE-3000**

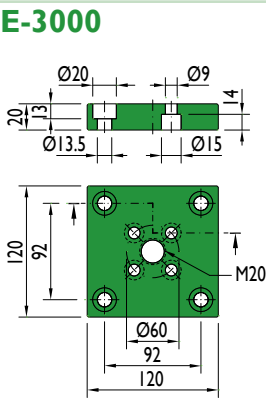

**BFI-3000**

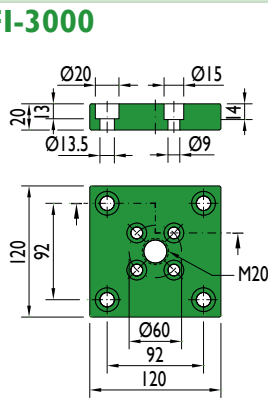

**MC-4000**

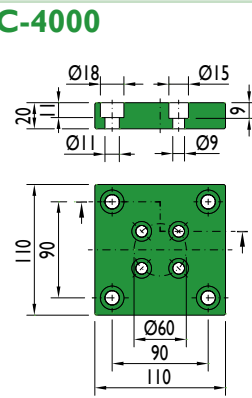

**XT-7500**

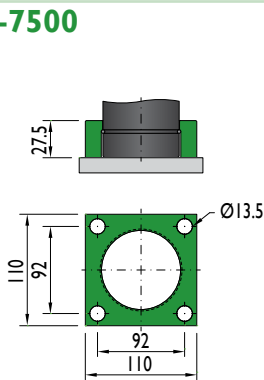

**XS-3000**

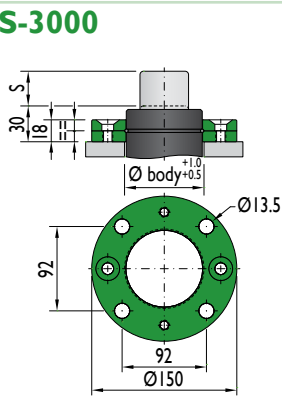

**XC-3000**

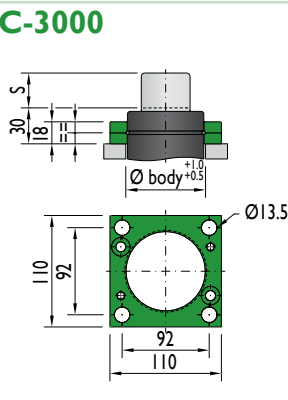

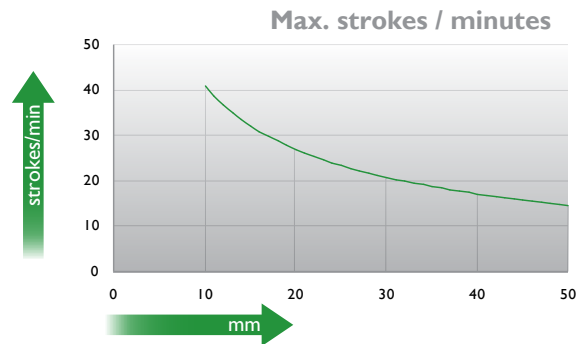
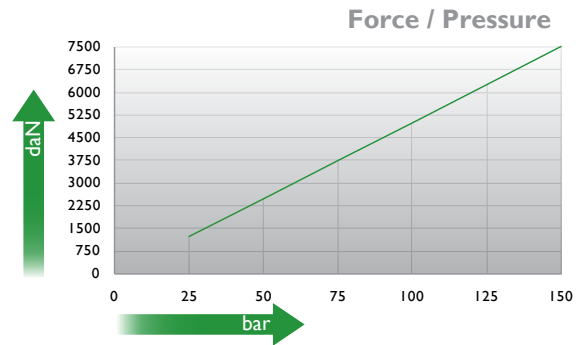
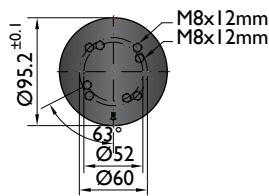
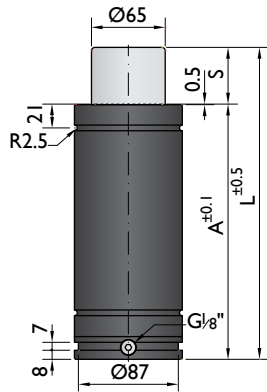

Ordering example: 4 x TC-7500-50

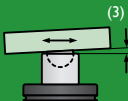
Order No.	S <sup>(1)</sup> mm	L mm	A mm	F <sub>0</sub> <sup>(2)</sup> daN (20°C, 150 bar)	F daN	 <sup>(3)</sup>	kg
TC-7500-10	10	110	100	7500	11100	No	3.47
TC-7500-16	16	136	120		9900	No	3.98
TC-7500-25	25	165	140		10400	No	4.78
TC-7500-32	32	202	170		10400	No	4.85
TC-7500-40	40	230	190		10400	No	4.98
TC-7500-50	50	275	225		10400	No	5.09

(1) other strokes under request      (2) alternative forces upon request      (3) ESK under request



Pressure medium	N <sub>2</sub>	Working temperature	0-80°C	Min. security stroke	10%
Max. Charging pressure	150 bar	Temperature related force increase	+0.34%/°C	Repair Kit	KIT TC-7500
Min. Charging pressure	25 bar	Max. working speed	0.5 m/s	Linkable	G1/8"

### Mounting possibilities

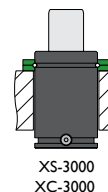
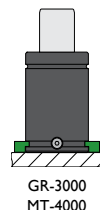
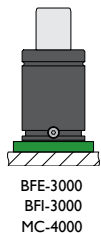
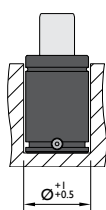
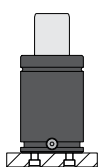

## Flanges

**BFE-3000**

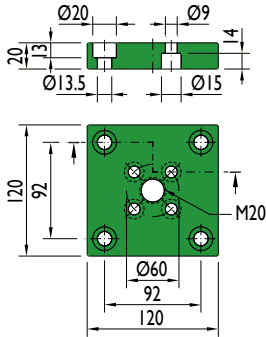

**BFI-3000**

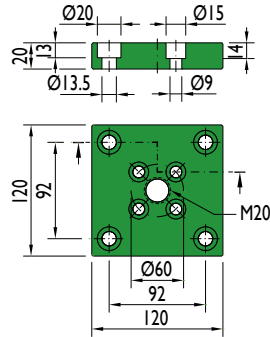

**MC-4000**

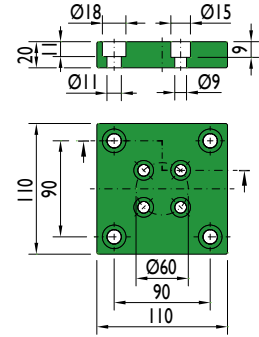

**GR-3000**

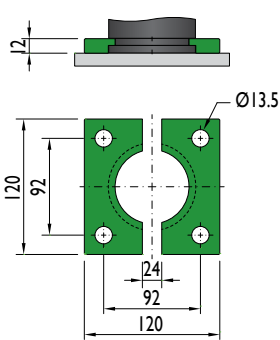

**MT-4000**

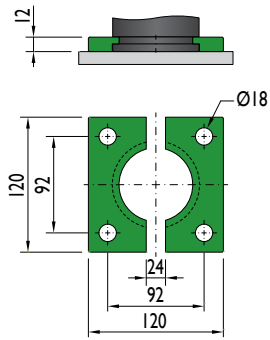

**XS-3000**

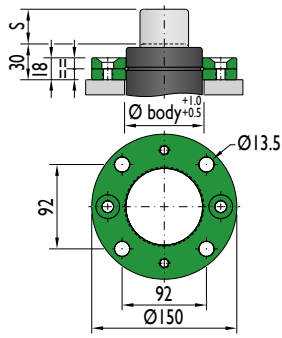

**XC-3000**

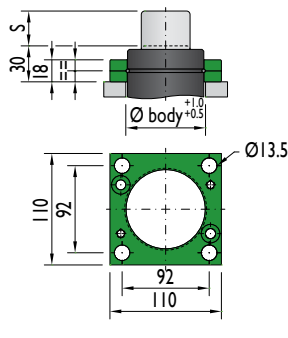





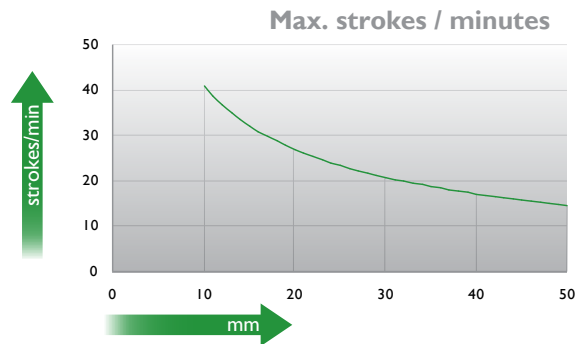
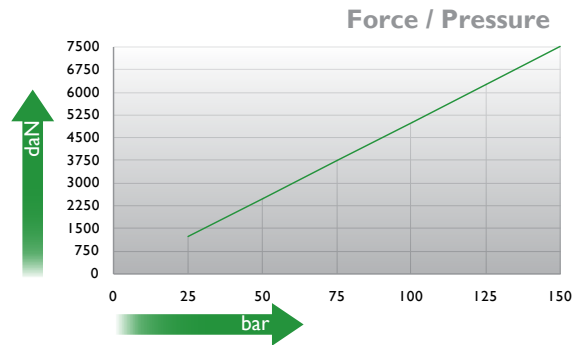
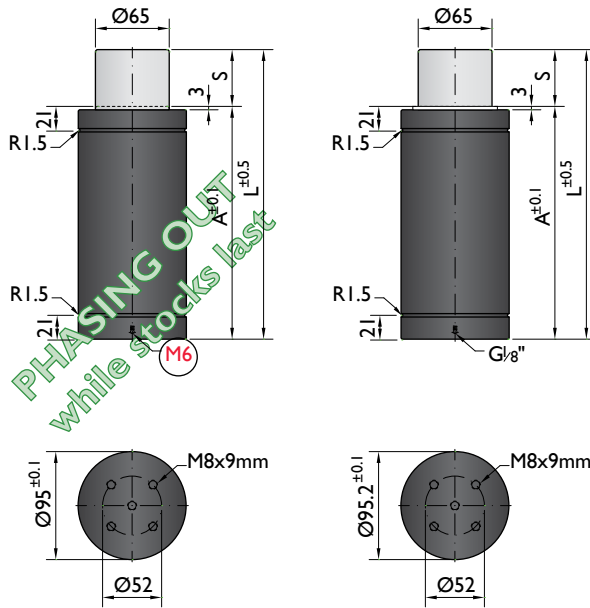

\*The new cylinder will be supplied when the stock runs out.

**NEW MODEL\***



Ordering example: 4 x TS-7500-50

Order No.	S <sup>(1)</sup> mm	L mm	A mm	F <sub>0</sub> <sup>(2)</sup> daN (20°C, 150 bar)	F daN		kg
TS-7500-10	10	90	80	7500	11100	No	2.52
TS-7500-16	16	116	100		9900	No	3.03
TS-7500-25	25	145	120		10400	No	3.83
TS-7500-32	32	182	150		10400	No	3.90
TS-7500-40	40	210	170		10400	No	4.03
TS-7500-50	50	255	205		10400	No	4.14
TS-7500-65	65	279	214		11000	No	4.33

other strokes <sup>(1)</sup> under request

alternative forces <sup>(2)</sup> upon request

ESK <sup>(3)</sup> under request



Pressure medium	N <sub>2</sub>	Working temperature	0-80°C	Min. security stroke	10%
Max. Charging pressure	150 bar	Temperature related force increase	+0.34%/°C	Repair Kit	KIT TS-7500
Min. Charging pressure	25 bar	Max. working speed	0.5 m/s	Linkable	No

**Mounting possibilities**

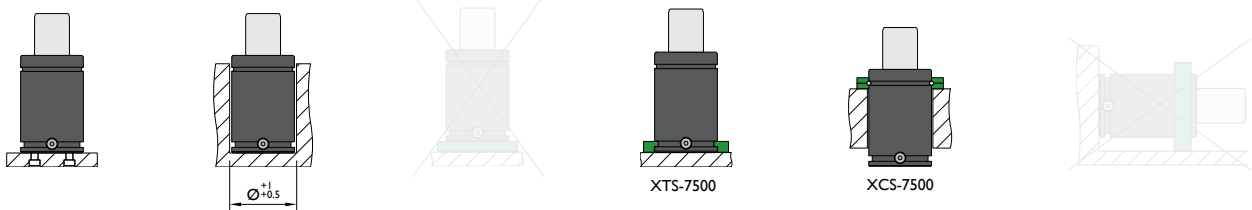

## Flanges

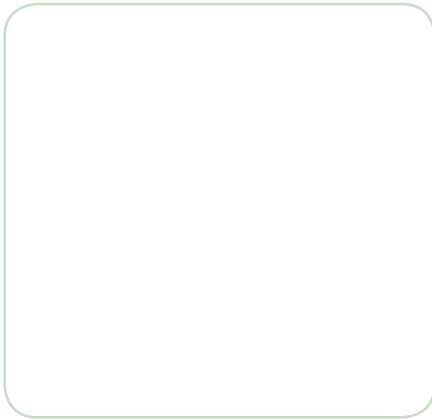
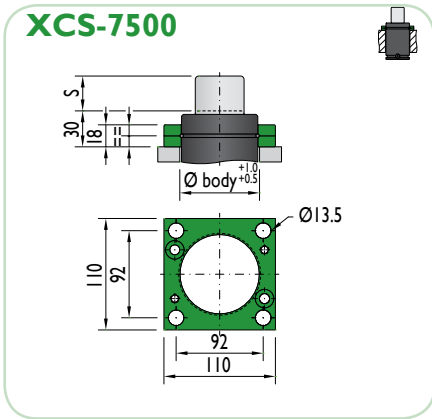
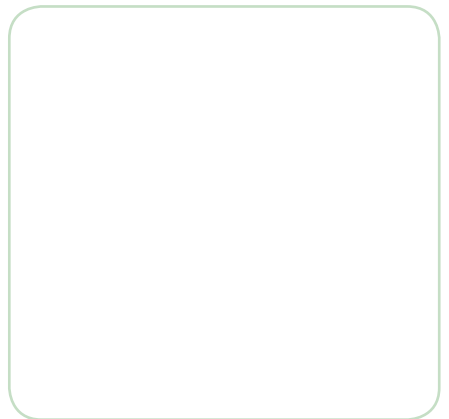
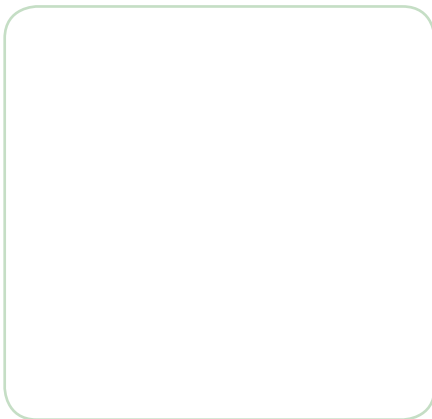
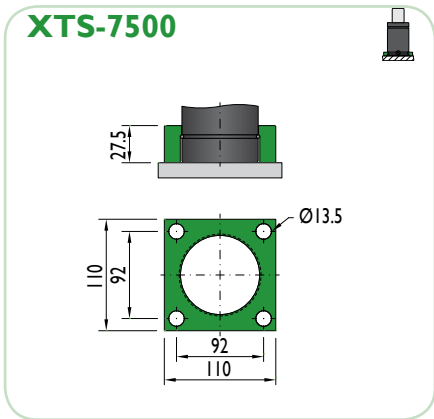

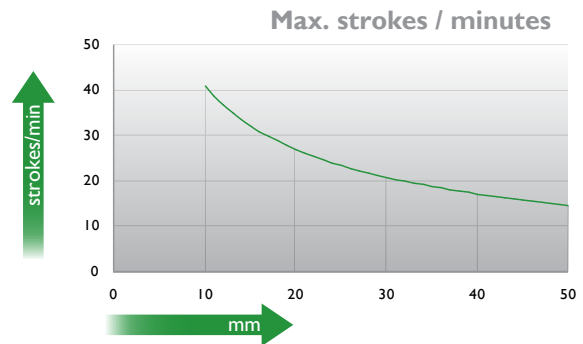
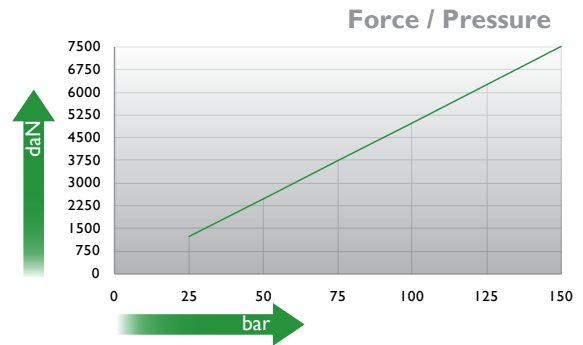
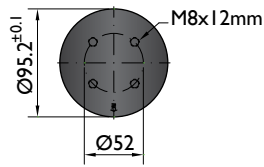
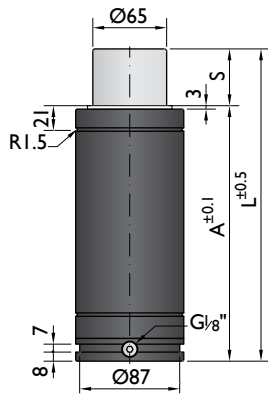

Ordering example: 4 x TSC-7500-50

Order No.	S <sup>(1)</sup> mm	L mm	A mm	F <sub>0</sub> <sup>(2)</sup> daN	F daN	(3)	kg
TSC-7500-10	10	110	100	7500 (20°C, 150 bar)	11100	No	3.47
TSC-7500-16	16	136	120		9900	No	3.98
TSC-7500-25	25	165	140		10400	No	4.78
TSC-7500-32	32	202	170		10400	No	4.85
TSC-7500-40	40	230	190		10400	No	4.98
TSC-7500-50	50	275	225		10400	No	5.09
TSC-7500-65	65	299	234		11000	No	5.28

other strokes <sup>(1)</sup> under request

alternative forces <sup>(2)</sup> upon request

ESK <sup>(3)</sup> under request



Pressure medium	N <sub>2</sub>	Working temperature	0-80°C	Min. security stroke	10%
Max. Charging pressure	150 bar	Temperature related force increase	+0.34%/°C	Repair Kit	KIT TSC-7500
Min. Charging pressure	25 bar	Max. working speed	0.5 m/s	Linkable	G1/8"

### Mounting possibilities

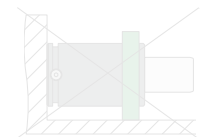
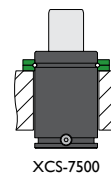
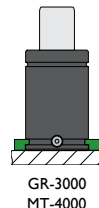
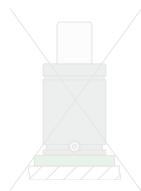
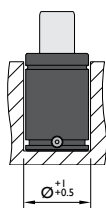
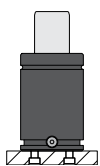

## Flanges

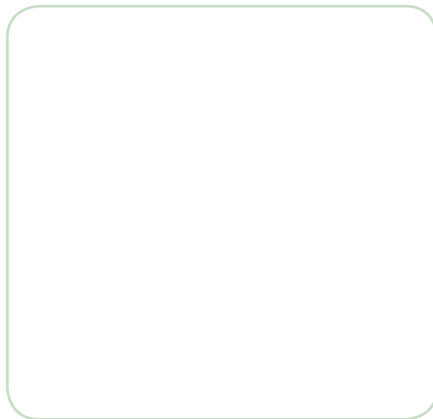
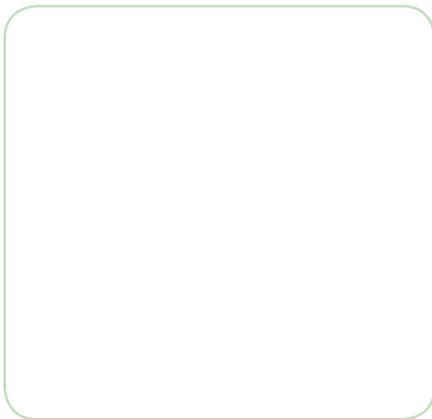
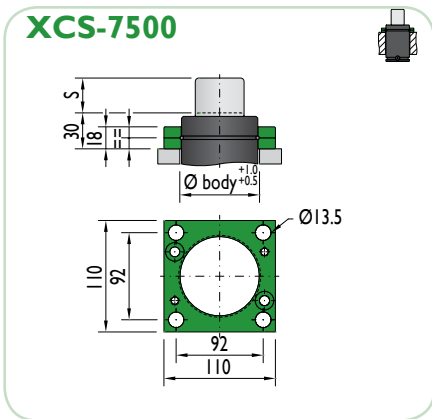
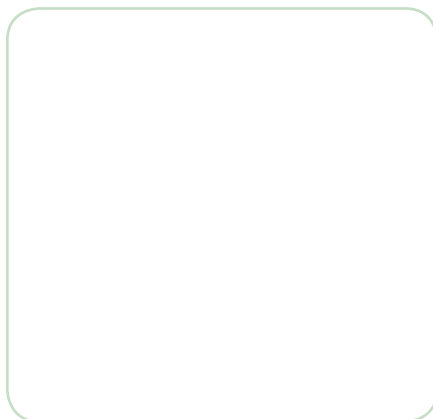
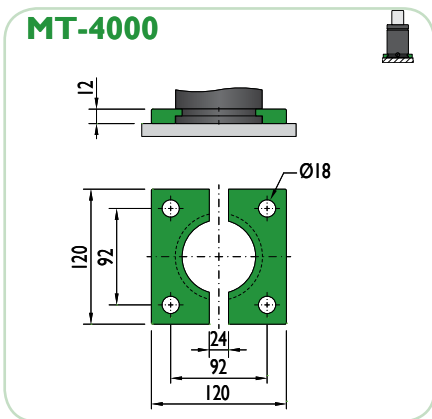
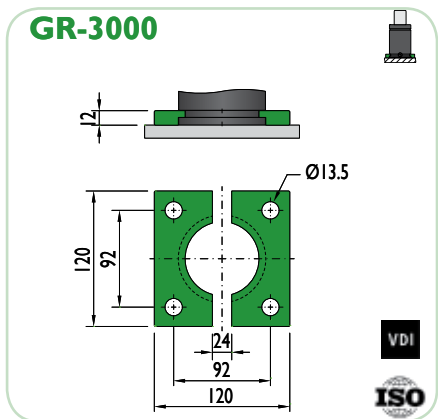
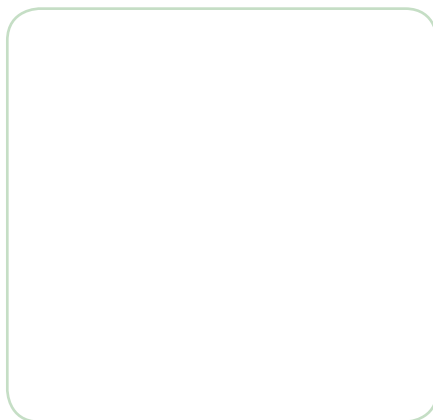
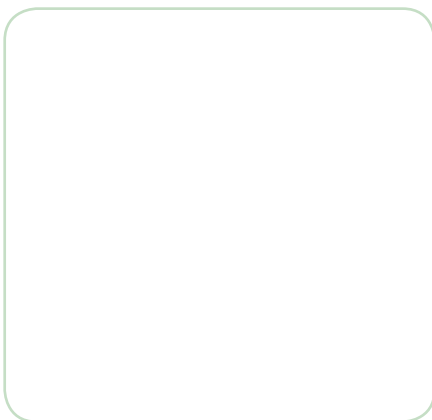
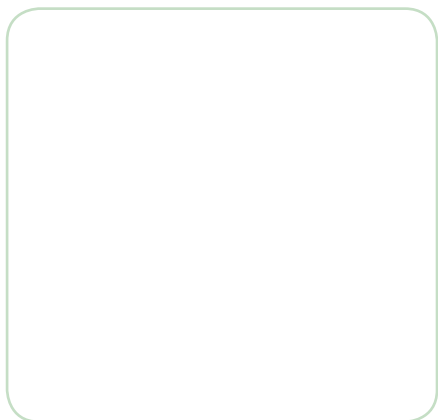

## Force 10000 daN

### Piston Rod Sealed gas springs

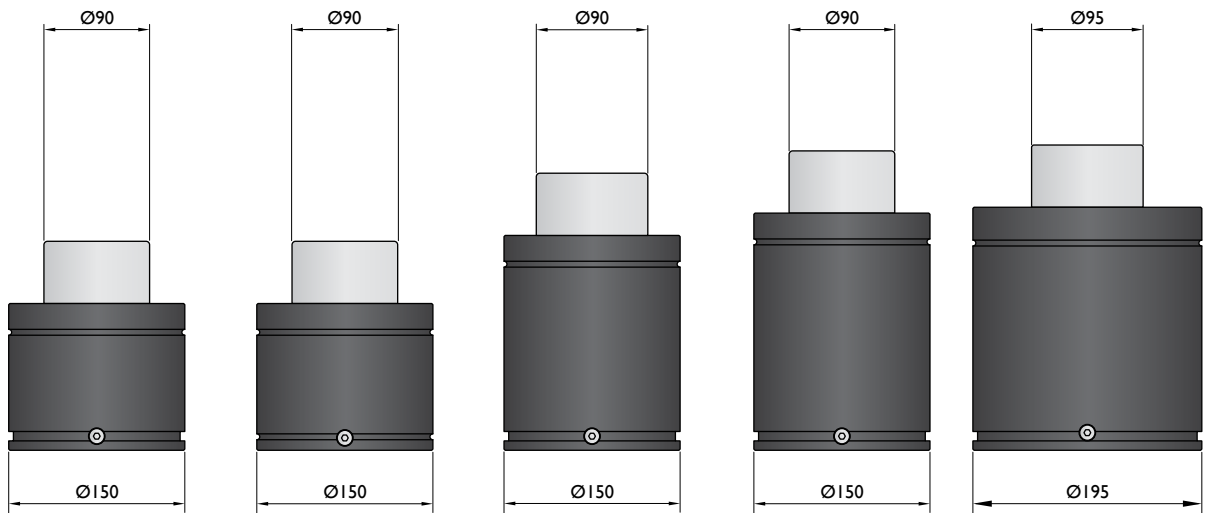
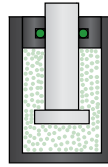

<b>Model</b>	<b>KP-9500</b>	<b>NT-9500</b>	<b>G-10000</b>	<b>HD-9500</b>	<b>CN-10000</b>
<b>Initial F (daN)</b>	9500	9500	9500	9500	10600
<b>L max (mm)</b>	2xStroke+78	2xStroke+78	2xStroke+136	2xStroke+155	2xStroke+160
<b>Stroke (mm)</b>	19-125	25-125	25-160	25-300	25-300

\* other strokes under request

### Standards

<b>PED</b> 97/23/EC	<b>PED</b> 97/23/EC	<b>PED</b> 97/23/EC	<b>PED</b> 97/23/EC	<b>PED</b> 97/23/EC
<b>ISO</b> 11901	<b>ISO</b> 11901	<b>ISO</b> 11901	<b>ISO</b> 11901	<b>ISO</b> 11901
<b>VDI</b> 3003	<b>VDI</b> 3003	<b>VDI</b> 3003	<b>VDI</b> 3003	<b>VDI</b> 3003
<b>CNOMO</b> EM24.54.700	<b>CNOMO</b> EM24.54.700	<b>CNOMO</b> EM24.54.700	<b>CNOMO</b> EM24.54.700	<b>CNOMO</b> EM24.54.700



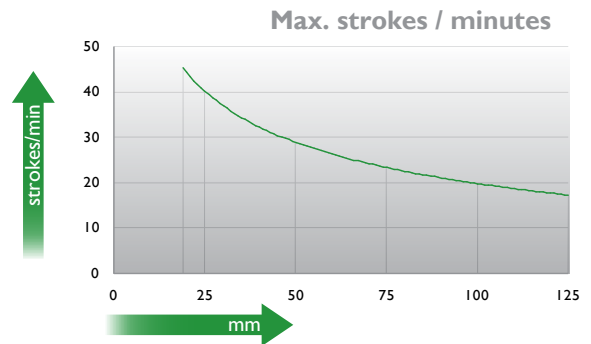
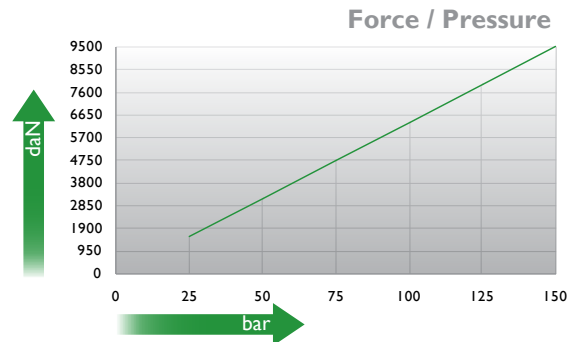
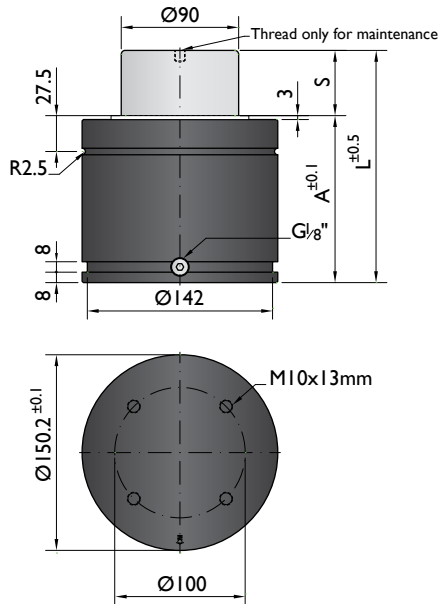

Ordering example: 4 x KP-9500-125

Order No.	S <sup>(1)</sup> mm	L mm	A mm	F <sub>0</sub> <sup>(2)</sup> daN (20°C, 150 bar)	F daN		kg
KP-9500-19	19	116	97	9500	12800	No	9.90
KP-9500-25	25	128	103		13200	No	10.25
KP-9500-32	32	142	110		13600	No	11.03
KP-9500-38	38	154	116		13800	No	12.16
KP-9500-50	50	178	128		14200	No	13.77
KP-9500-63	63	204	141		17400	Yes	14.73
KP-9500-75	75	228	153		17300	Yes	15.63
KP-9500-80	80	238	158		17300	Yes	15.97
KP-9500-100	100	278	178		17200	Yes	16.53
KP-9500-125	125	328	203		17100	Yes	17.15

<sup>(1)</sup> other strokes under request

<sup>(2)</sup> alternative forces upon request

<sup>(3)</sup> ESK available for other strokes



Pressure medium	N <sub>2</sub>	Working temperature	0-80°C	Min. security stroke	10%
Max. Charging pressure	150 bar	Temperature related force increase	+0.34%/°C	Repair Kit	KIT KP-9500
Min. Charging pressure	25 bar	Max. working speed	1.6 m/s	Linkable	G1/8"

## Mounting possibilities

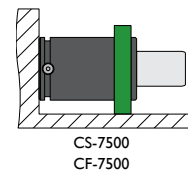
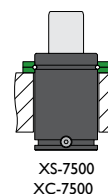
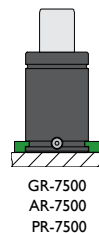
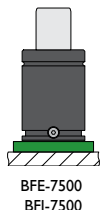
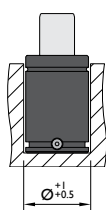
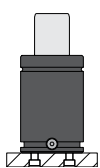

Flange must not support spring's force

## Flanges

**BFE-7500**

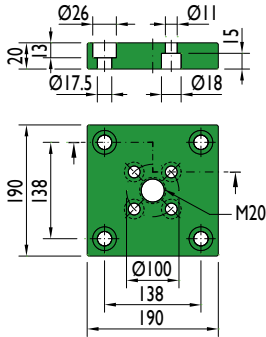

**BFI-7500**

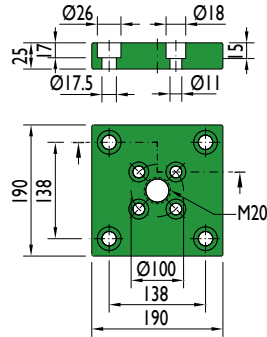

**GR-7500**

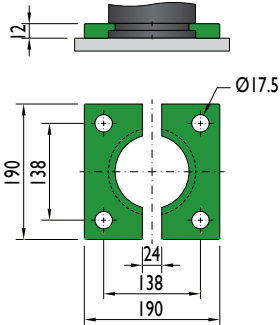

**AR-7500**

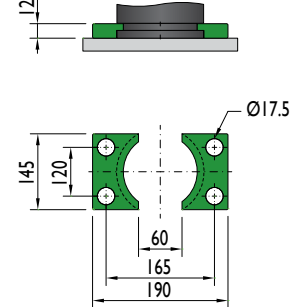

**XS-7500**

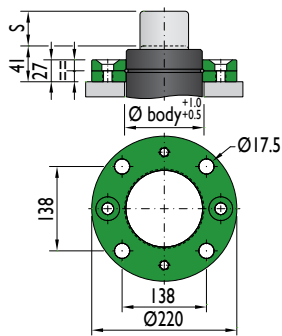

**XC-7500**

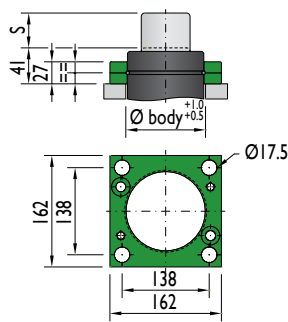

**PR-7500**

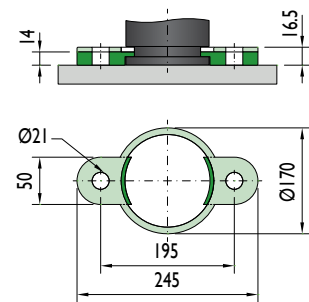

**CS-7500**

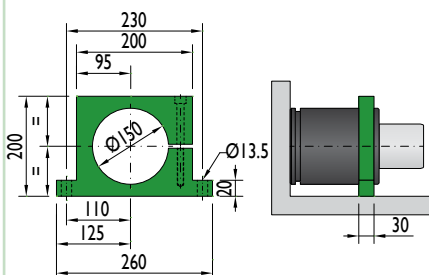

Flange must not support spring's force

**CF-7500**

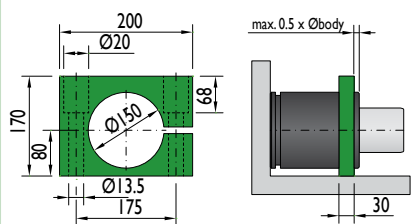

Flange must not support spring's force



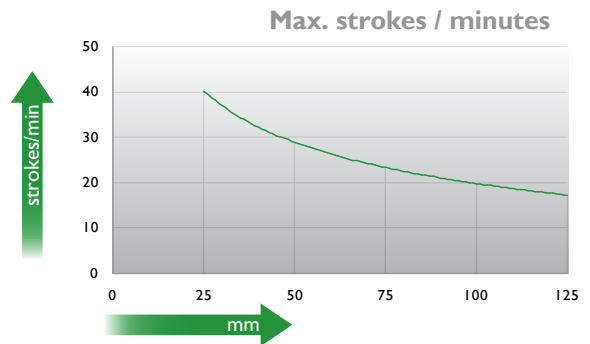
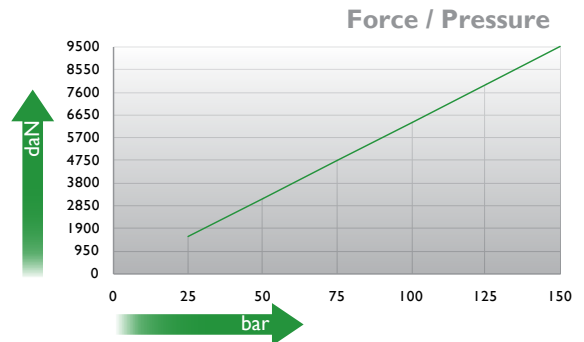
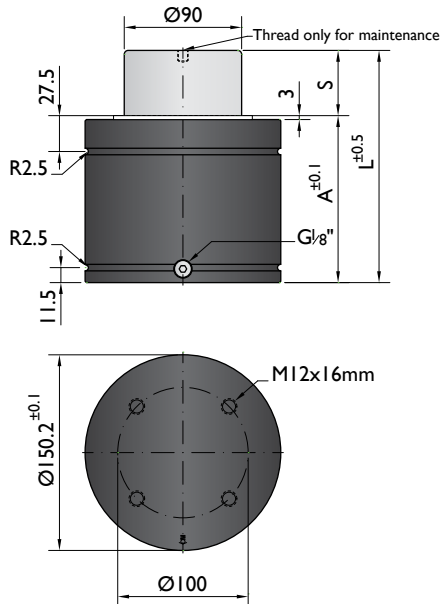

Ordering example: 4 x NT-9500-125

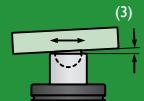
Order No.	S <sup>(1)</sup> mm	L mm	A mm	F <sub>0</sub> <sup>(2)</sup> daN (20°C, 150 bar)	F daN	 <sup>(3)</sup>	kg
NT-9500-25	25	128	103		13200	No	11.60
NT-9500-32	32	142	110		13600	No	12.18
NT-9500-38	38	154	116		13800	No	12.67
NT-9500-50	50	178	128		14200	No	13.66
NT-9500-63	63	204	141	9500	17400	Yes	14.73
NT-9500-75	75	228	153		17300	Yes	15.72
NT-9500-80	80	238	158		17300	Yes	14.14
NT-9500-100	100	278	178		17200	Yes	17.78
NT-9500-125	125	328	203		17100	Yes	19.85

<sup>(1)</sup> other strokes under request

<sup>(2)</sup> alternative forces upon request

<sup>(3)</sup> ESK available for other strokes



Pressure medium	N <sub>2</sub>	Working temperature	0-80°C	Min. security stroke	10%
Max. Charging pressure	150 bar	Temperature related force increase	+0.34%/°C	Repair Kit	KIT NT-9500
Min. Charging pressure	25 bar	Max. working speed	1.6 m/s	Linkable	G1/8"

## Mounting possibilities

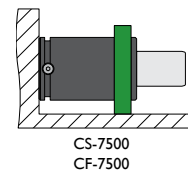
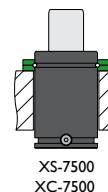
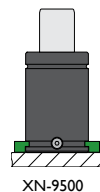
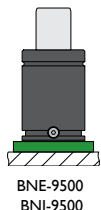
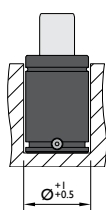
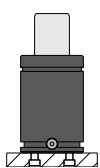

Flange must not support spring's force

## Flanges

### BNE-9500

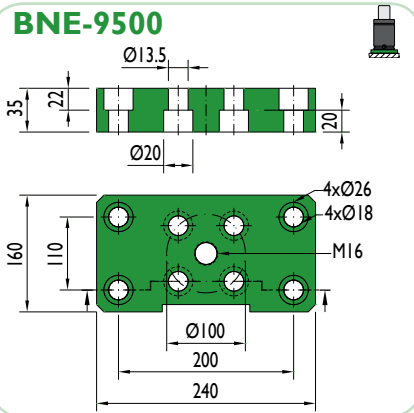

### BNI-9500

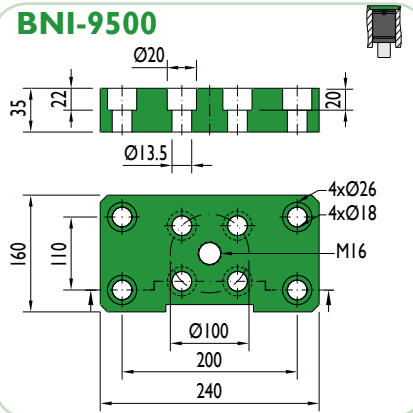

### XN-9500

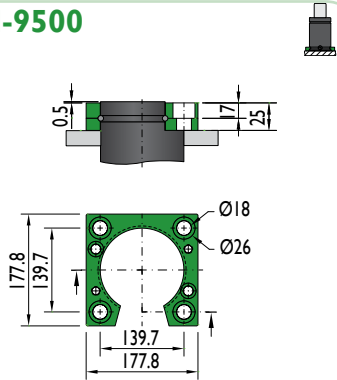

### XS-7500

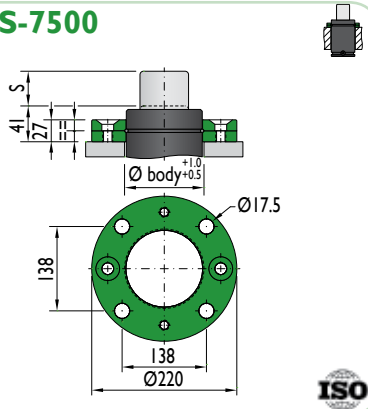

### XC-7500

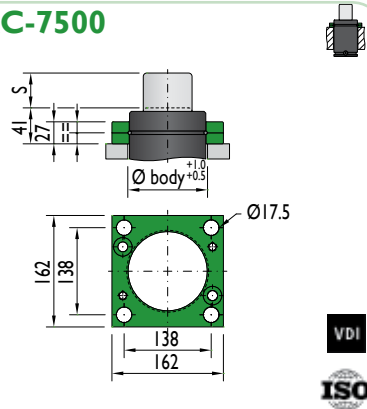

### CS-7500

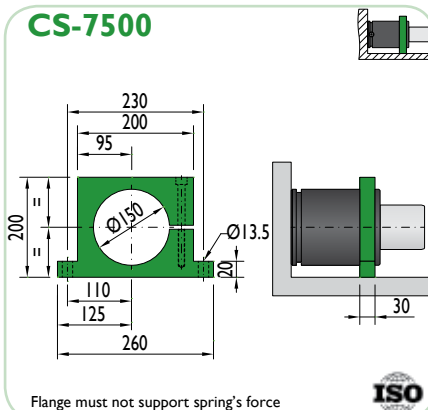

### CF-7500

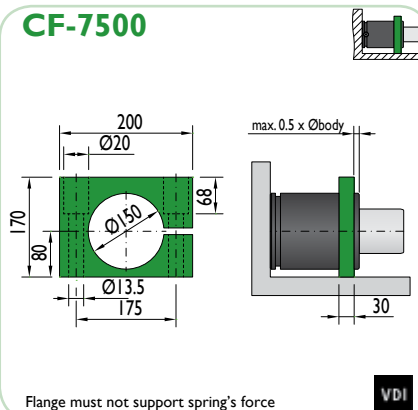



\*The new cylinder will be supplied when the stock runs out.

**NEW MODEL\***

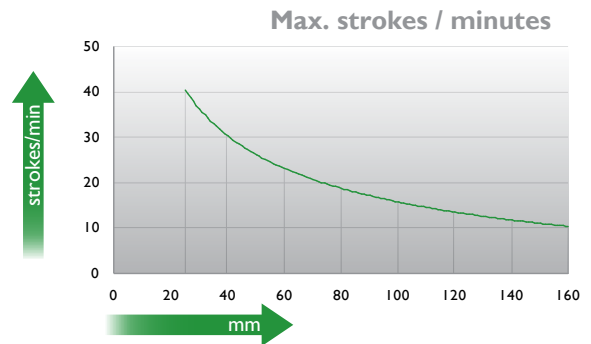
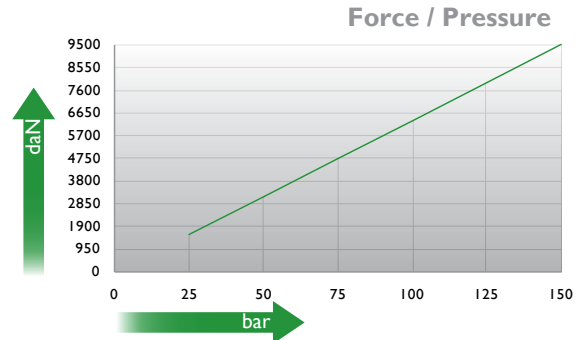
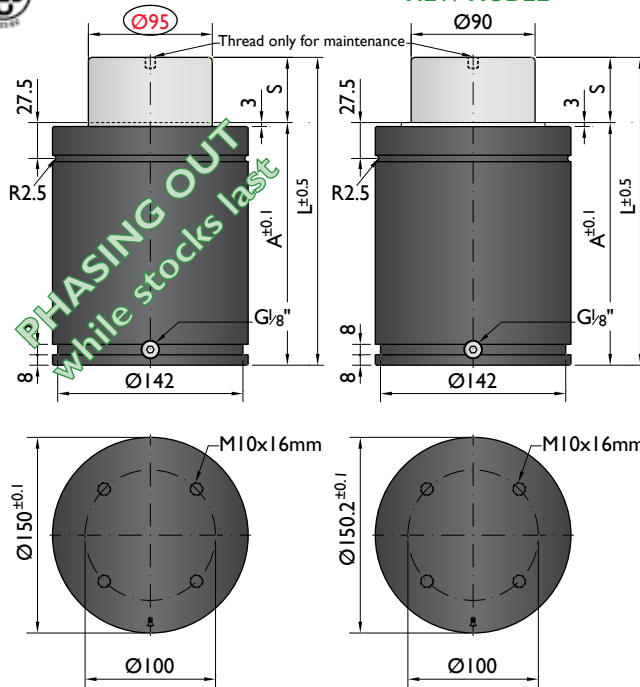

Ordering example: 4 x G-10000-125

Order No.	S <sup>(1)</sup> mm	L mm	A mm	F <sub>0</sub> <sup>(2)</sup> daN (20°C, 150 bar)	F daN		kg
G-10000-25	25	186	161	9500	12400	No	16.63
G-10000-38	38	212	174		13100	No	17.48
G-10000-50	50	236	186		13550	No	18.28
G-10000-63	63	262	199		14000	No	19.15
G-10000-80	80	296	216		14230	No	20.28
G-10000-100	100	336	236		15200	Yes	22.55
G-10000-125	125	386	261		15400	Yes	24.22
G-10000-160	160	456	296		15500	Yes	26.55

other strokes <sup>(1)</sup> under request

alternative forces <sup>(2)</sup> upon request

ESK available <sup>(3)</sup> for other strokes



Pressure medium	N <sub>2</sub>	Working temperature	0-80°C	Min. security stroke	10%
Max. Charging pressure	150 bar	Temperature related force increase	+0.34%/°C	Repair Kit	KIT G-10000
Min. Charging pressure	25 bar	Max. working speed	1.6 m/s	Linkable	G1/8"

### Mounting possibilities

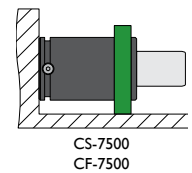
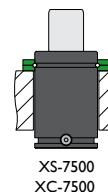
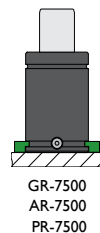
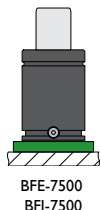
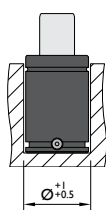
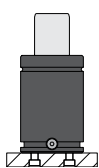

Flange must not support spring's force

## Flanges

**BFE-7500**

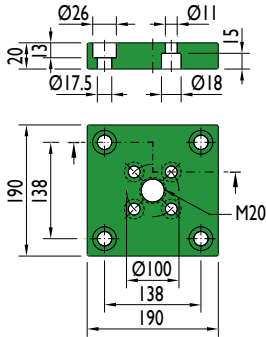

**BFI-7500**

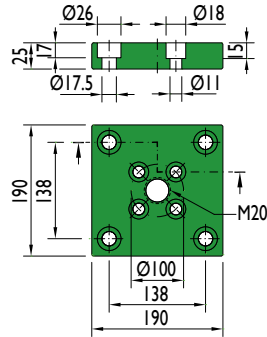

**GR-7500**

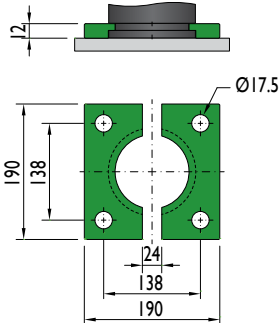

**AR-7500**

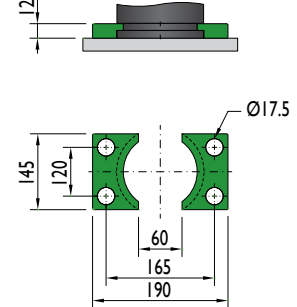

**XS-7500**

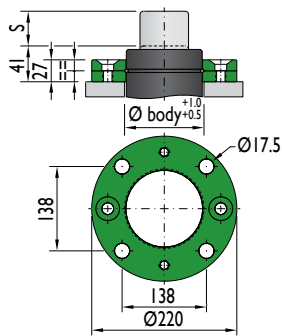

**XC-7500**

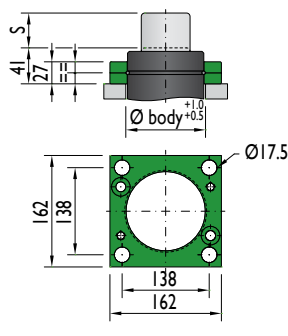

**PR-7500**

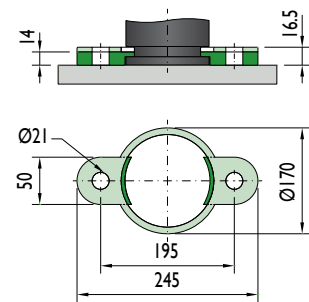

**CS-7500**

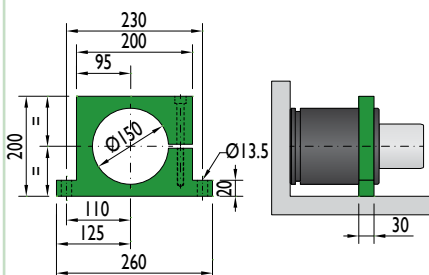

Flange must not support spring's force

**CF-7500**

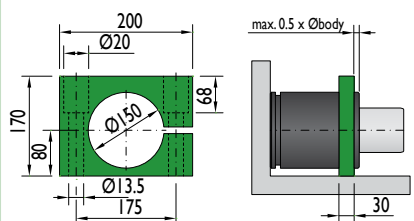

Flange must not support spring's force

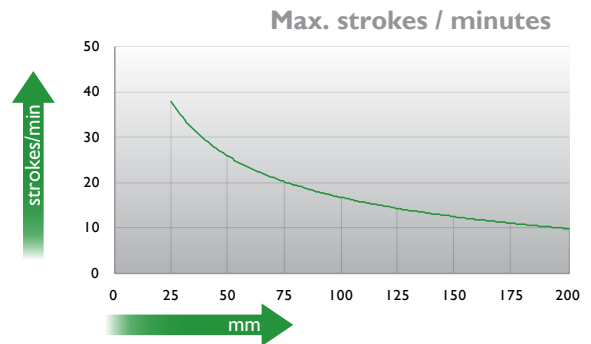
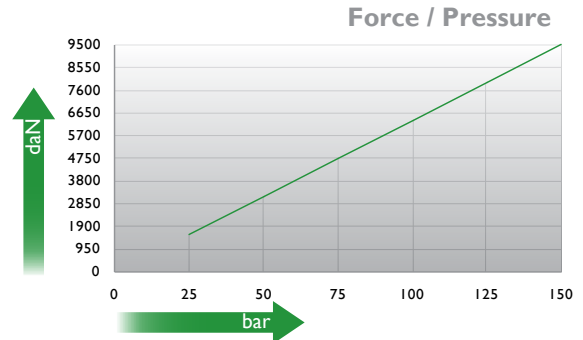
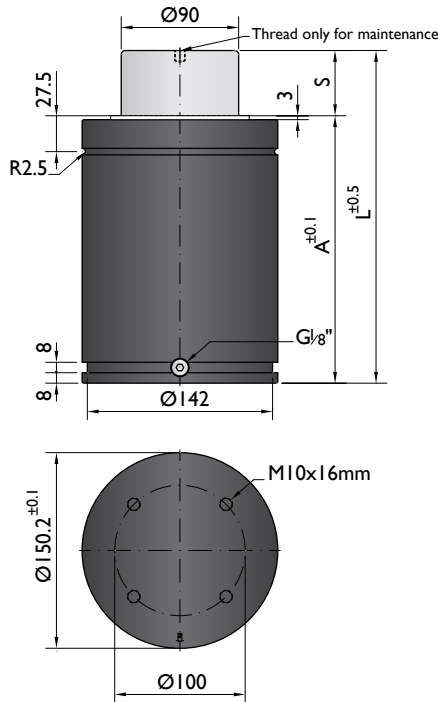

Ordering example: 4 x HD-9500-200

Order No.	S <sup>(1)</sup> mm	L mm	A mm	F <sub>0</sub> <sup>(2)</sup> daN (20°C, 150 bar)	F daN		kg
HD-9500-25	25	205	180	9500	11700	No	17.96
HD-9500-38	38	231	193		12400	No	18.95
HD-9500-50	50	255	205		12900	No	20.62
HD-9500-63	63	281	218		13300	No	21.60
HD-9500-80	80	315	235		13800	No	22.88
HD-9500-100	100	355	255		15100	Yes	24.84
HD-9500-125	125	405	280		15400	Yes	26.74
HD-9500-160	160	475	315		15800	Yes	29.37
HD-9500-200	200	555	355		16000	Yes	32.38
HD-9500-250	250	655	405		16300	Yes	35.63
HD-9500-300	300	755	455	16500	Yes	38.87	

<sup>(1)</sup> other strokes under request

<sup>(2)</sup> alternative forces upon request

<sup>(3)</sup> ESK available for other strokes



Pressure medium	N <sub>2</sub>	Working temperature	0-80°C	Min. security stroke	10%
Max. Charging pressure	150 bar	Temperature related force increase	+0.34%/°C	Repair Kit	KIT HD-9500
Min. Charging pressure	25 bar	Max. working speed	1.6 m/s	Linkable	G1/8"

### Mounting possibilities

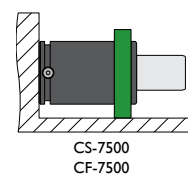
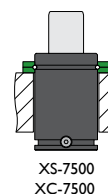
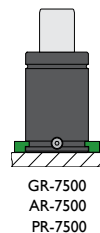
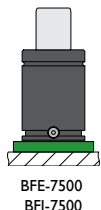
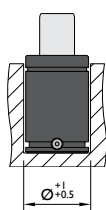
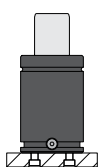

Flange must not support spring's force

## Flanges

**BFE-7500**

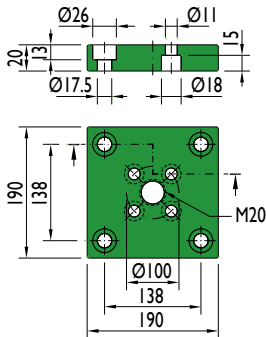

**BFI-7500**

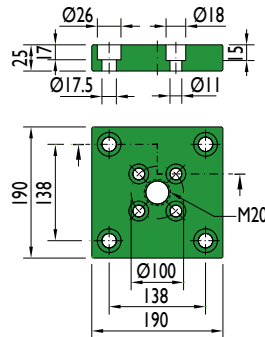

**GR-7500**

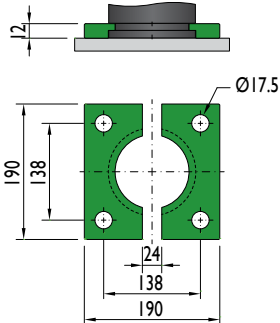

**AR-7500**

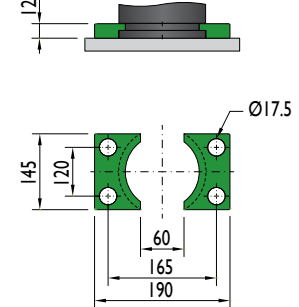

**XS-7500**

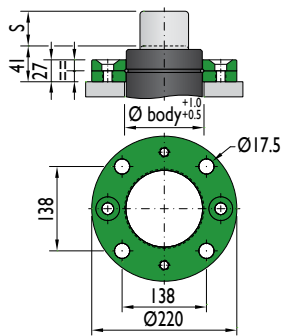

**XC-7500**

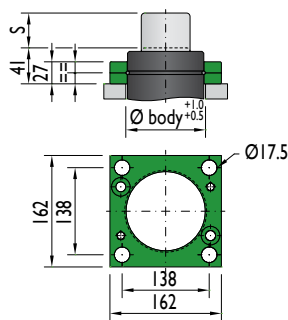

**PR-7500**

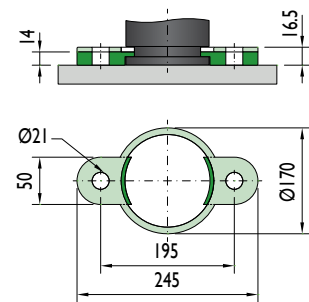

**CS-7500**

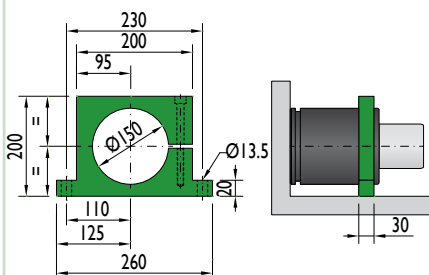

Flange must not support spring's force

**CF-7500**

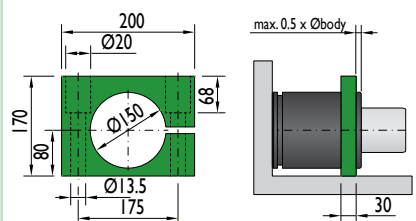

Flange must not support spring's force



CNOMO  
EM24.54.700

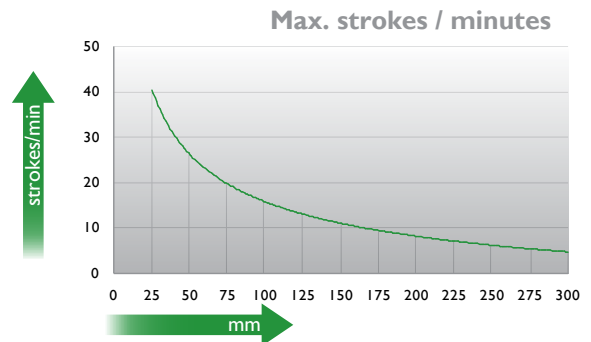
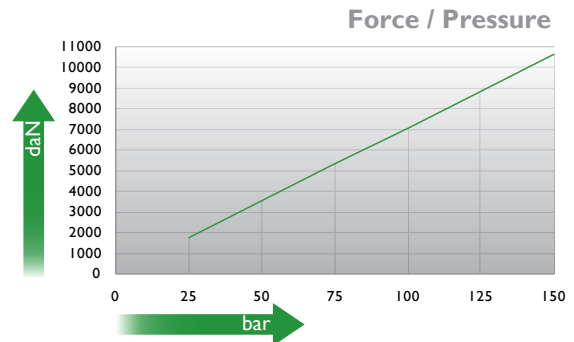
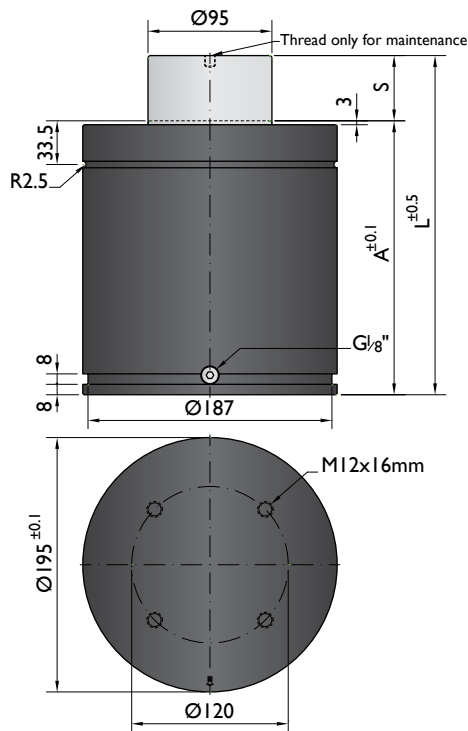

Ordering example: 4 x CN-10000-200

Order No.	S <sup>(1)</sup> mm	L mm	A mm	F <sub>0</sub> <sup>(2)</sup> daN (20°C, 150 bar)	F daN		kg
CN-10000-25	25	210	185		13000	No	32.40
CN-10000-38	38.1	236.2	198.1		13500	No	34.30
CN-10000-50	50	260	210		13800	No	36.20
CN-10000-63	63.5	287	223.5		14000	No	38.10
CN-10000-80	80	320	240		14200	No	40.70
CN-10000-100	100	360	260	10600	14400	No	43.80
CN-10000-125	125	410	285		14800	Yes	47.60
CN-10000-160	160	480	320		14900	Yes	52.90
CN-10000-200	200	560	360		15200	Yes	59.10
CN-10000-250	250	660	410		15200	Yes	66.60
CN-10000-300	300	760	460		15200	Yes	74.20

<sup>(1)</sup> other strokes under request

<sup>(2)</sup> alternative forces upon request

<sup>(3)</sup> ESK available for other strokes



Pressure medium	N <sub>2</sub>	Working temperature	0-80°C	Min. security stroke	10%
Max. Charging pressure	150 bar	Temperature related force increase	+0.34%/°C	Repair Kit	KIT CN-10000
Min. Charging pressure	25 bar	Max. working speed	1.6 m/s	Linkable	G1/8"

## Mounting possibilities

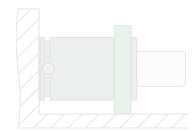
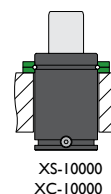
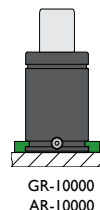
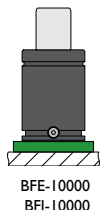
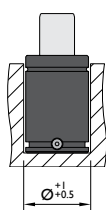
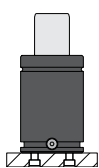

## Flanges

**BFE-10000**

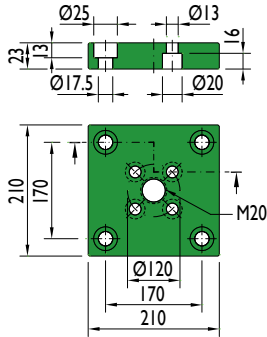

**BFI-10000**

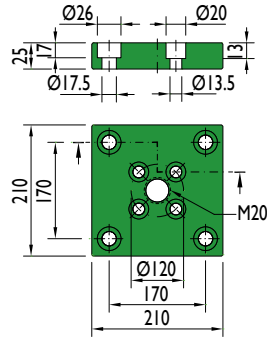

**GR-10000**

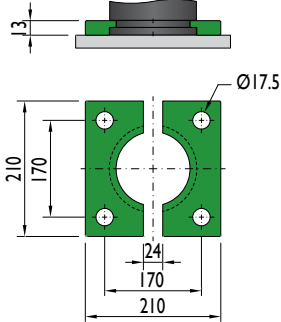

**AR-10000**

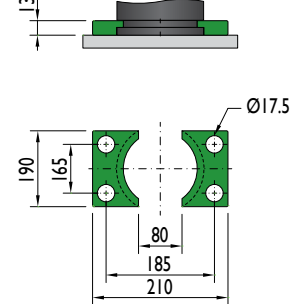

**XS-10000**

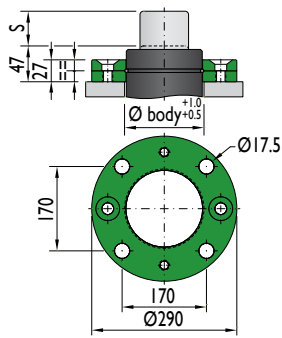

**XC-10000**

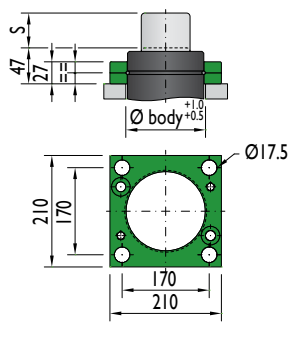





## Force 12000 daN

Bore Sealed  
gas springs

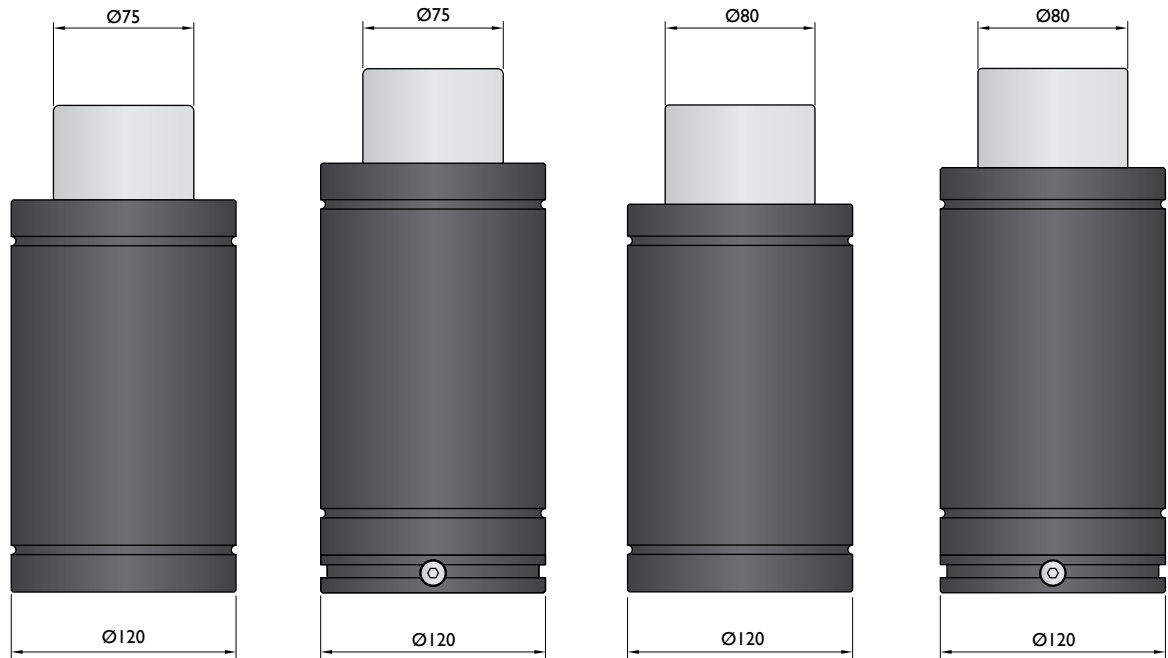
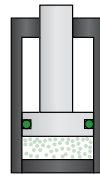

Model	T-II1800	TC-II1800	TS-II1800	TSC-II1800
Initial F (daN)	11800	11800	11800	11800
L max (mm)	100-260	120-280	100-320	120-340
Stroke (mm)	10-50	10-50	10-65	10-65

\* other strokes under request

Standards

PED  
97/23/EC

ISO  
11901

VDI  
3003

CNOMO  
EM24.54.700

PED  
97/23/EC

ISO  
11901

VDI  
3003

CNOMO  
EM24.54.700

PED  
97/23/EC

ISO  
11901

VDI  
3003

CNOMO  
EM24.54.700

PED  
97/23/EC

ISO  
11901

VDI  
3003

CNOMO  
EM24.54.700



## Flanges

**BFE-5000**

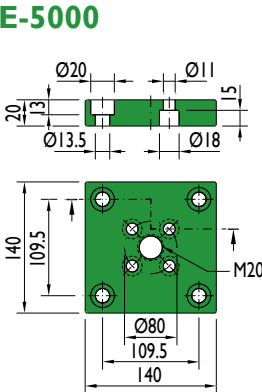

**BFI-5000**

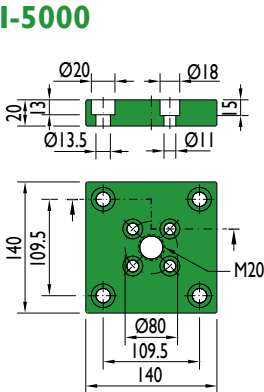

**MC-6500**

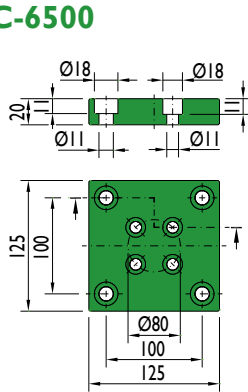

**XT-11800**

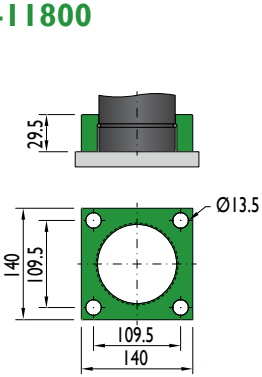

**XS-5000**

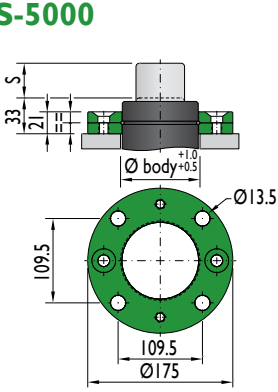

**XC-5000**

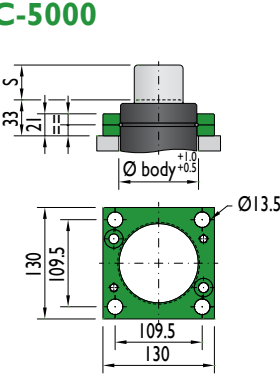

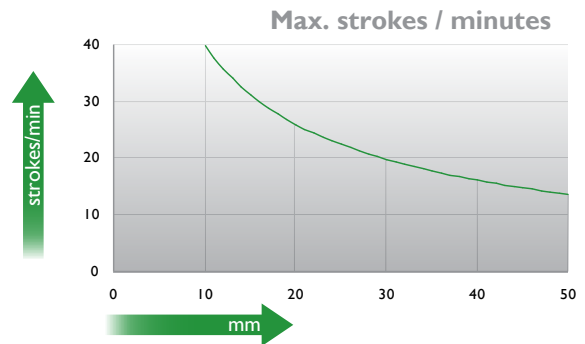
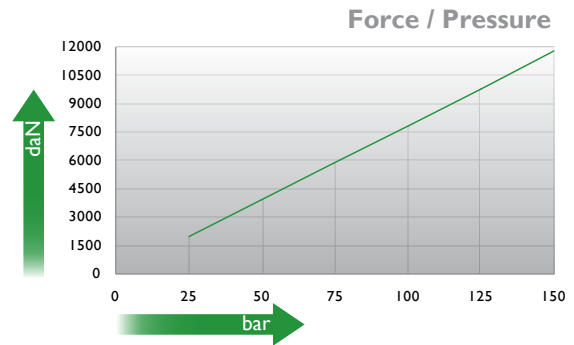
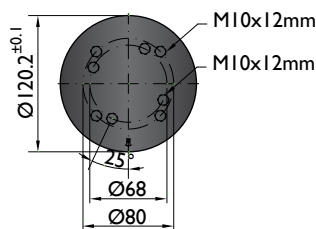
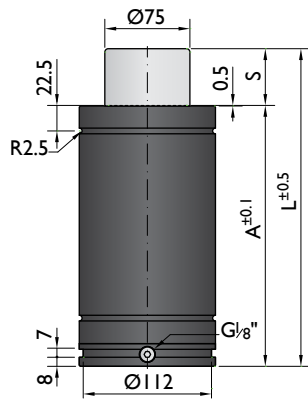

Ordering example: 4 x TC-11800-50

Order No.	S <sup>(1)</sup> mm	L mm	A mm	F <sub>0</sub> <sup>(2)</sup> daN	F daN	(3)	kg
				(20°C, 150 bar)			
TC-11800-10	10	120	110	11800	15500	No	6.16
TC-11800-16	16	146	130		15700	No	7.30
TC-11800-25	25	175	150		16600	No	8.04
TC-11800-32	32	207	175		16600	No	8.80
TC-11800-40	40	240	200		16600	No	9.70
TC-11800-50	50	280	230		16600	No	10.72

(1) other strokes under request      (2) alternative forces upon request      (3) ESK under request



Pressure medium	N <sub>2</sub>	Working temperature	0-80°C	Min. security stroke	10%
Max. Charging pressure	150 bar	Temperature related force increase	+0.34%/°C	Repair Kit	KIT TC-11800
Min. Charging pressure	25 bar	Max. working speed	0.5 m/s	Linkable	G1/8"

### Mounting possibilities

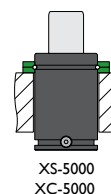
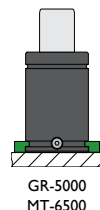
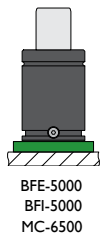
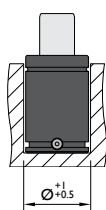
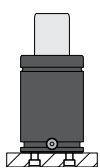

## Flanges

**BFE-5000**

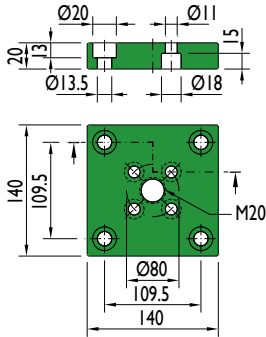

**BFI-5000**

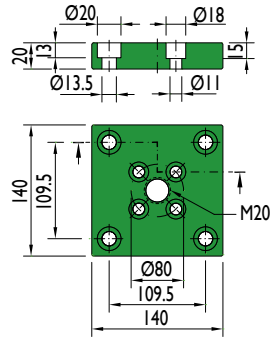

**MC-6500**

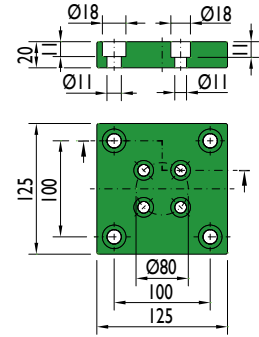

**GR-5000**

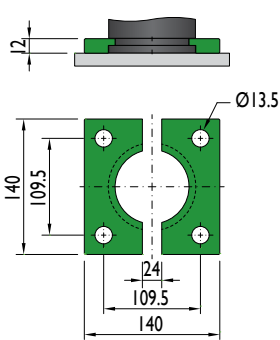

**MT-6500**

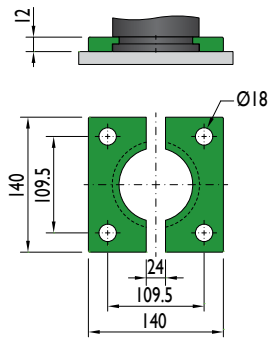

**XS-5000**

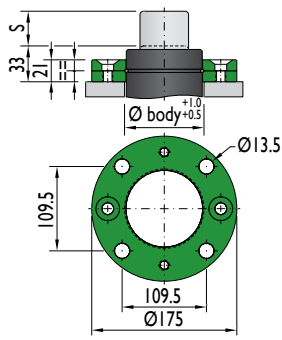

**XC-5000**

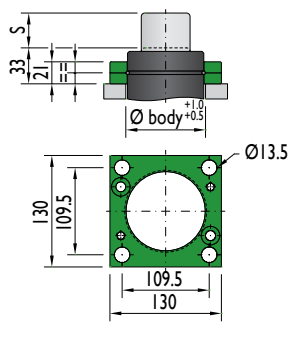

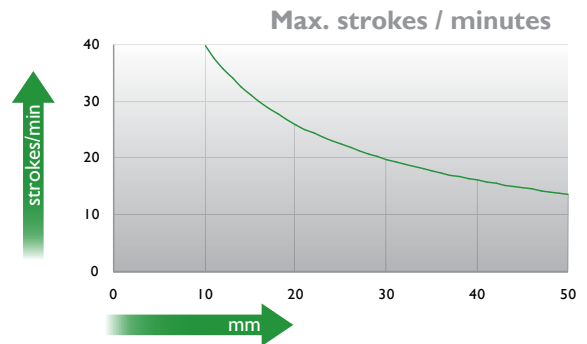
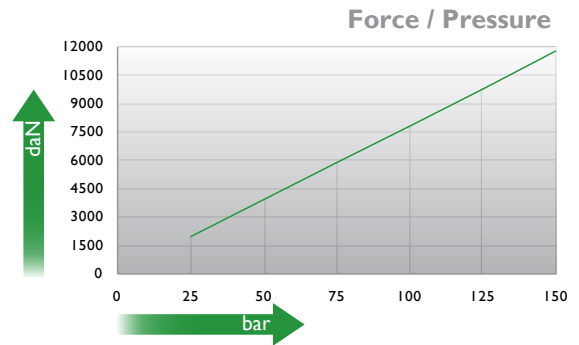
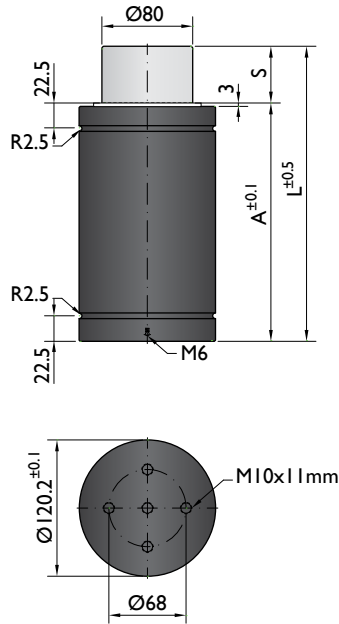

Ordering example: 4 x TS-11800-50

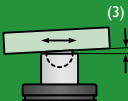
Order No.	S <sup>(1)</sup> mm	L mm	A mm	F <sub>0</sub> <sup>(2)</sup> daN (20°C, 150 bar)	F daN		kg
TS-11800-10	10	100	90	11800	15500	No	4.60
TS-11800-16	16	126	110		15700	No	5.74
TS-11800-25	25	155	130		16600	No	6.48
TS-11800-32	32	187	155		16600	No	7.30
TS-11800-40	40	220	180		16600	No	8.14
TS-11800-50	50	260	210		16600	No	9.16
TS-11800-65	65	320	255		16600	No	10.14

other strokes <sup>(1)</sup> under request

alternative forces <sup>(2)</sup> upon request

ESK <sup>(3)</sup> under request



Pressure medium	N <sub>2</sub>	Working temperature	0-80°C	Min. security stroke	10%
Max. Charging pressure	150 bar	Temperature related force increase	+0.34%/°C	Repair Kit	KIT TS-11800
Min. Charging pressure	25 bar	Max. working speed	0.5 m/s	Linkable	No

### Mounting possibilities

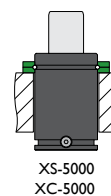
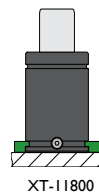
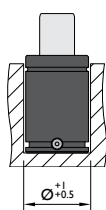
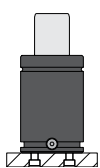

## Flanges



**XT-11800**

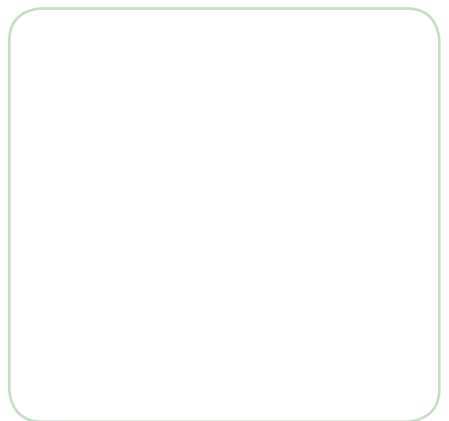
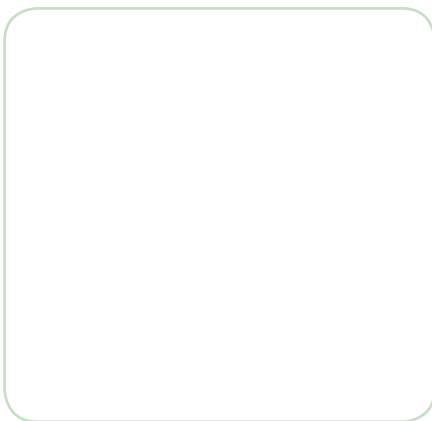

**XS-5000**

**XC-5000**





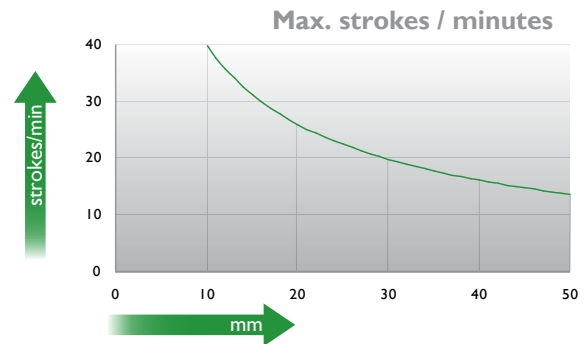
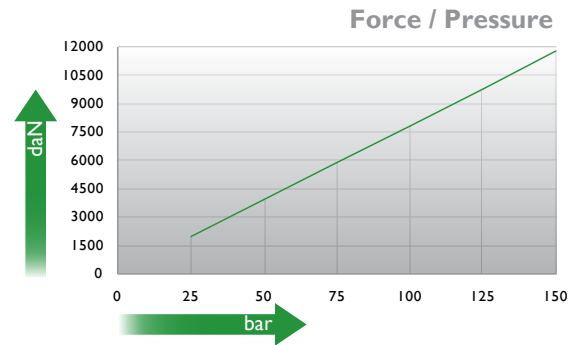
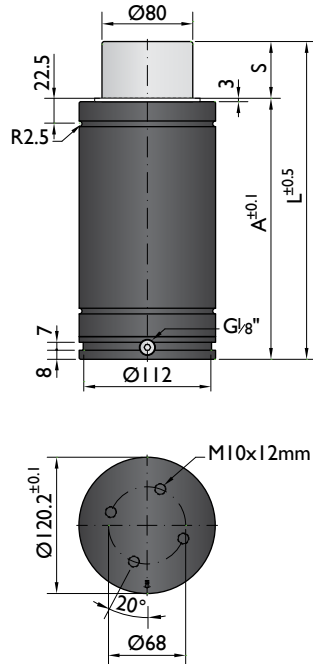

Ordering example: 4 x TSC-I 1800-50

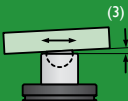
Order No.	S <sup>(1)</sup> mm	L mm	A mm	F <sub>0</sub> <sup>(2)</sup> daN (20°C, 150 bar)	F daN	 <sup>(3)</sup>	kg
TSC-I 1800-10	10	120	110	11800	15500	No	6.16
TSC-I 1800-16	16	146	130		15700	No	7.30
TSC-I 1800-25	25	175	150		16600	No	8.04
TSC-I 1800-32	32	207	175		16600	No	8.80
TSC-I 1800-40	40	240	200		16600	No	9.70
TSC-I 1800-50	50	280	230		16600	No	10.72
TSC-I 1800-65	65	340	275		16600	No	11.70

other strokes <sup>(1)</sup> under request

alternative forces <sup>(2)</sup> upon request

ESK <sup>(3)</sup> under request



Pressure medium	N <sub>2</sub>	Working temperature	0-80°C	Min. security stroke	10%
Max. Charging pressure	150 bar	Temperature related force increase	+0.34%/°C	Repair Kit	KIT TSC-I 1800
Min. Charging pressure	25 bar	Max. working speed	0.5 m/s	Linkable	G1/8"

### Mounting possibilities

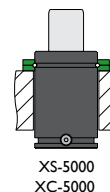
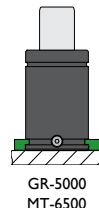
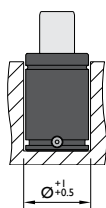
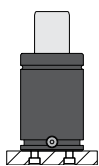

## Flanges



**GR-5000**

ISO

**MT-6500**

ISO

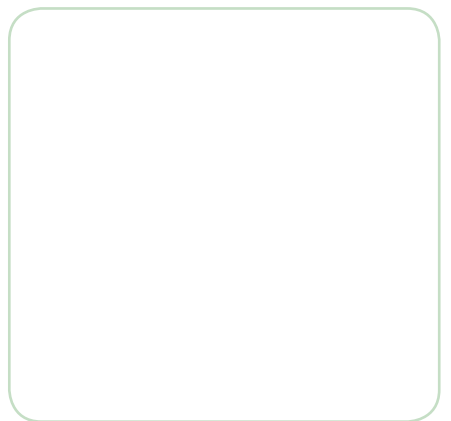

**XS-5000**

ISO

**XC-5000**

VDI  
ISO



## Force 20000 daN

### Piston Rod Sealed gas springs

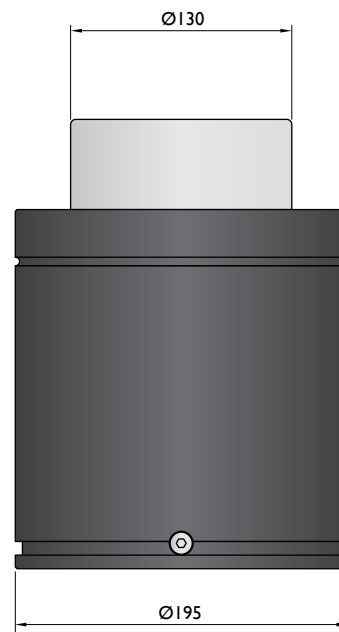
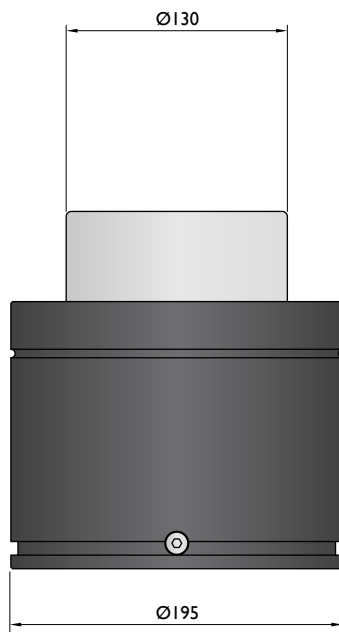
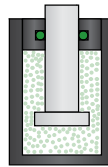

<b>Model</b>	<b>KP-20000</b>	<b>HD-20000</b>
<b>Initial F (daN)</b>	20000	20000
<b>L max (mm)</b>	2xStroke+110	2xStroke+160
<b>Stroke (mm)</b>	19-125	25-300

\* other strokes under request

### Standards

**PED**  
97/23/EC

**ISO**  
11901

**VDI**  
3003

**CNOMO**  
EM24.54.700

**PED**  
97/23/EC

**ISO**  
11901

**VDI**  
3003

**CNOMO**  
EM24.54.700

## Force 2000 daN

Bore Sealed  
gas springs

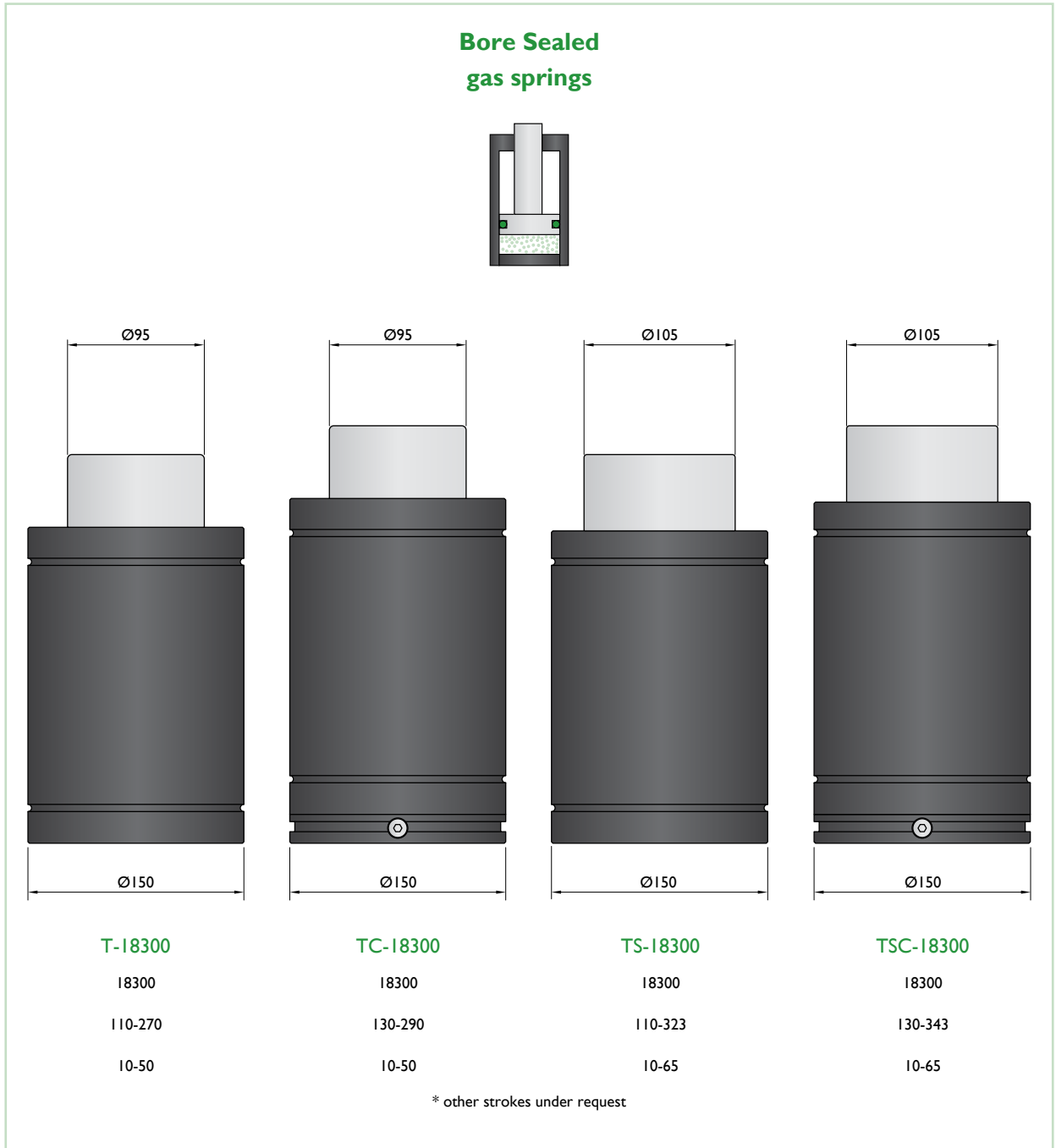
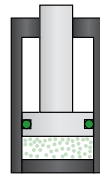

Standards

PED 97/23/EC	PED 97/23/EC	PED 97/23/EC	PED 97/23/EC
ISO 11901	ISO 11901	ISO 11901	ISO 11901
VDI 3003	VDI 3003	VDI 3003	VDI 3003
CNOMO EM24.54.700	CNOMO EM24.54.700	CNOMO EM24.54.700	CNOMO EM24.54.700

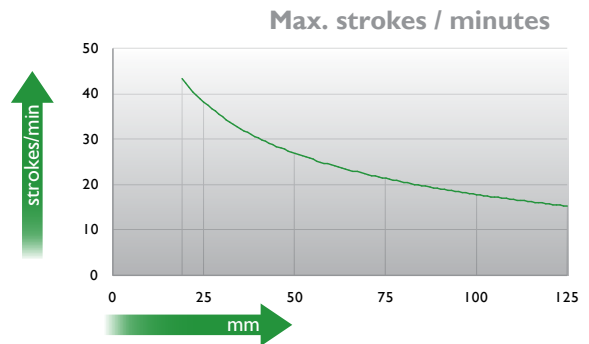
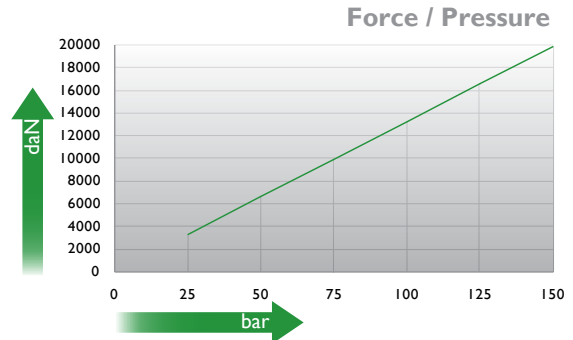
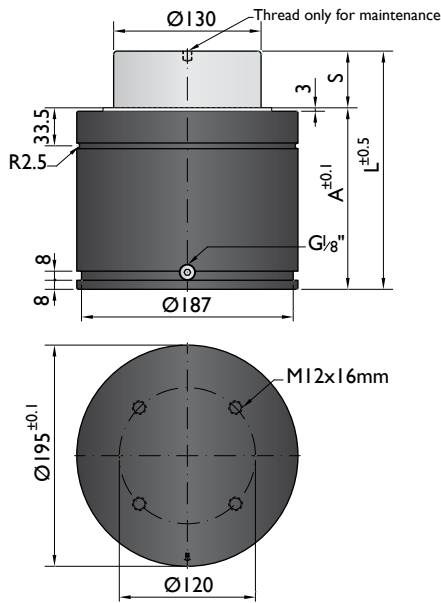

Ordering example: 4 x KP-20000-125

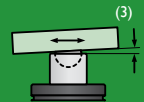
Order No.	S <sup>(1)</sup> mm	L mm	A mm	F <sub>0</sub> <sup>(2)</sup> daN (20°C, 150 bar)	F daN	 <sup>(3)</sup>	kg
KP-20000-19	19	148	129	20000	28200	No	22.63
KP-20000-25	25	160	135		29500	No	23.16
KP-20000-32	32	174	142		30700	No	23.76
KP-20000-38	38	186	148		31500	No	25.66
KP-20000-50	50	210	160		32700	No	27.31
KP-20000-63	63	236	173		39200	No	28.02
KP-20000-75	75	260	185		39200	No	29.53
KP-20000-80	80	270	190		39200	No	31.45
KP-20000-100	100	310	210		39200	No	32.70
KP-20000-125	125	360	235		39200	No	35.30

<sup>(1)</sup> other strokes under request

<sup>(2)</sup> alternative forces upon request



Pressure medium	N <sub>2</sub>	Working temperature	0-80°C	Min. security stroke	10%
Max. Charging pressure	150 bar	Temperature related force increase	+0.34%/°C	Repair Kit	KIT KP-20000
Min. Charging pressure	25 bar	Max. working speed	1.6 m/s	Linkable	G1/8"

## Mounting possibilities

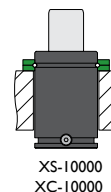
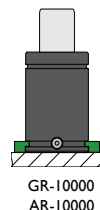
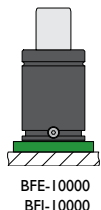
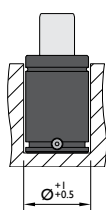
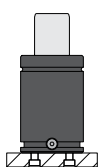

## Flanges

**BFE-10000**

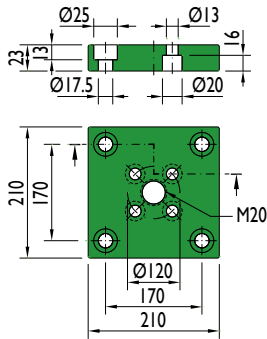

**BFI-10000**

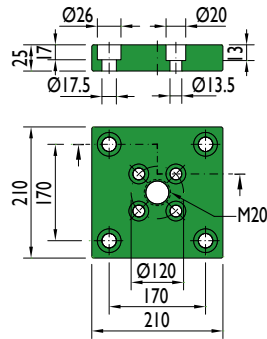

**GR-10000**

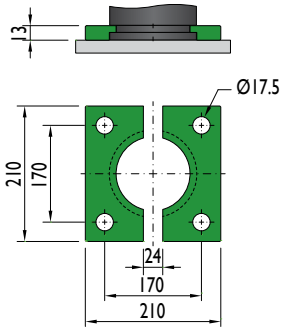

**AR-10000**

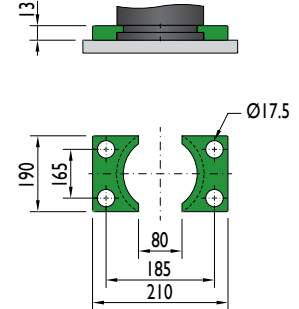

**XS-10000**

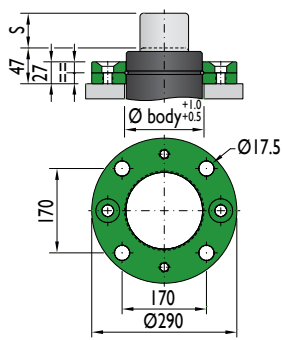

**XC-10000**

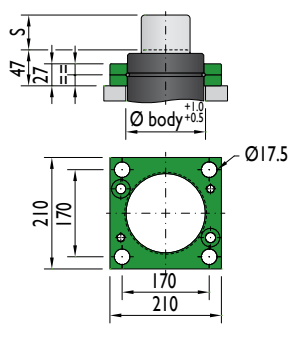

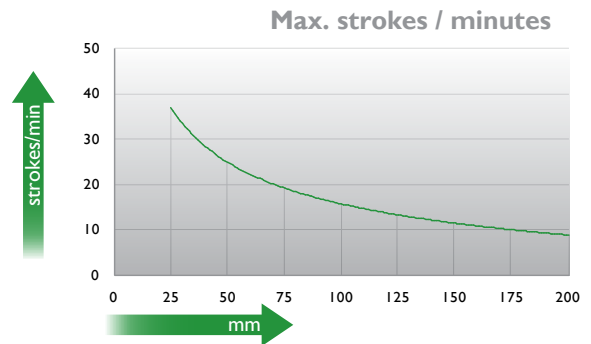
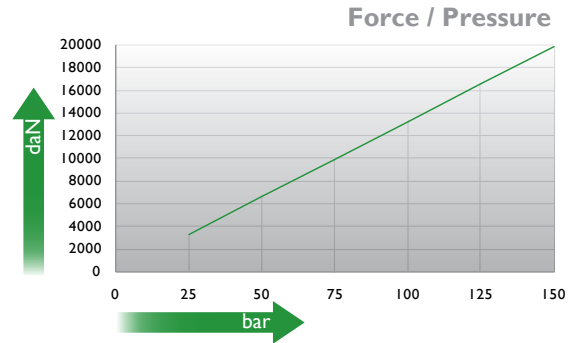
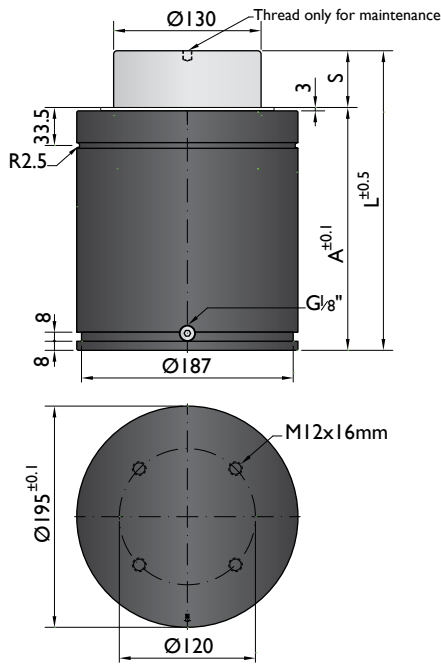

Ordering example: 4 x HD-20000-125

Order No.	S <sup>(1)</sup> mm	L mm	A mm	F <sub>0</sub> <sup>(2)</sup> daN (20°C, 150 bar)	F daN		kg
HD-20000-25	25	210	185	20000	26000	No	28.75
HD-20000-38	38	236	198		27600	No	31.68
HD-20000-50	50	260	210		29000	No	33.47
HD-20000-63	63	286	223		29700	No	35.02
HD-20000-80	80	320	240		30700	No	39.6
HD-20000-100	100	360	260		31500	No	40.34
HD-20000-125	125	410	285		32200	No	43.5
HD-20000-160	160	480	320		33000	No	46.58
HD-20000-200	200	560	360		33500	No	51.23
HD-20000-250	250	660	410		34200	No	70.2
HD-20000-300	300	760	460	35000	No	76.62	

<sup>(1)</sup> other strokes under request

<sup>(2)</sup> alternative forces upon request



Pressure medium	N <sub>2</sub>	Working temperature	0-80°C	Min. security stroke	10%
Max. Charging pressure	150 bar	Temperature related force increase	+0.34%/°C	Repair Kit	KIT HD-20000
Min. Charging pressure	25 bar	Max. working speed	1.6 m/s	Linkable	G1/8"

### Mounting possibilities

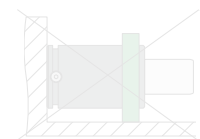
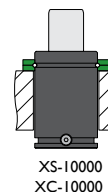
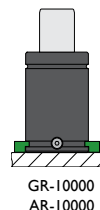
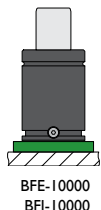
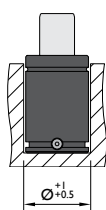
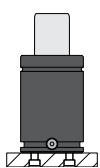

## Flanges

**BFE-10000**

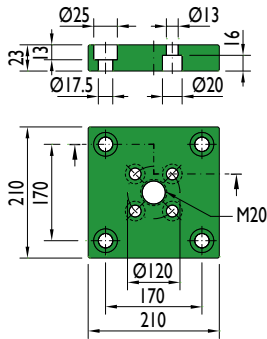

**BFI-10000**

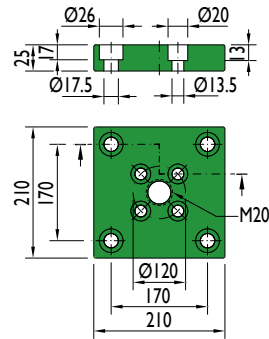

**GR-10000**

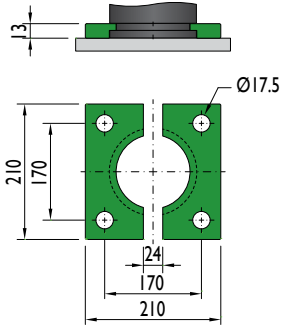

**AR-10000**

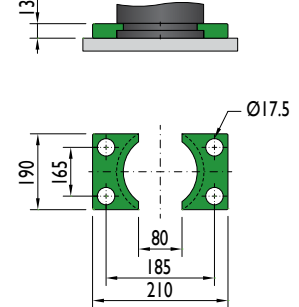

**XS-10000**

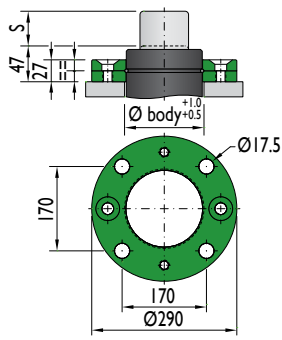

**XC-10000**

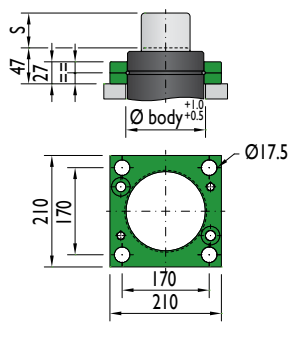



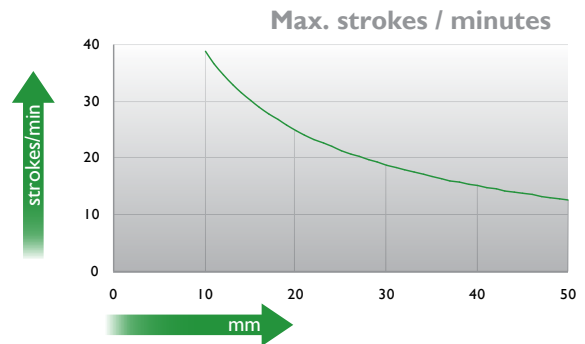
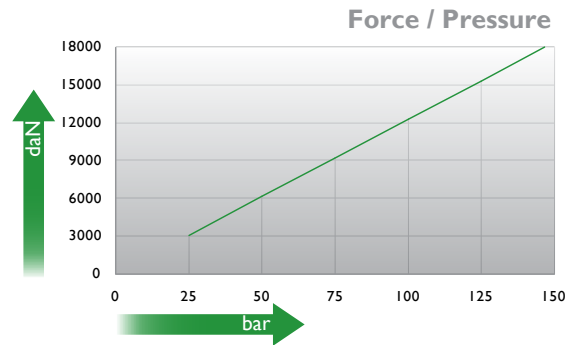
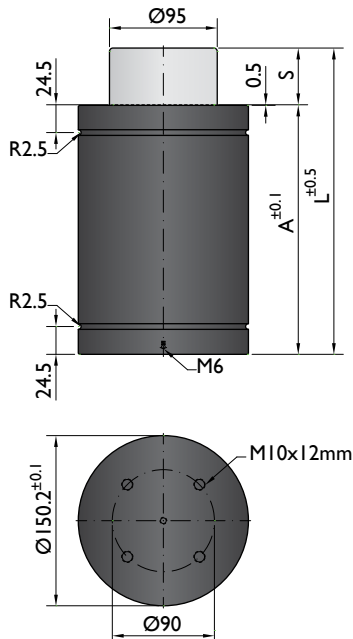

Ordering example: 4 x T-18300-50

Order No.	S <sup>(1)</sup> mm	L mm	A mm	F <sub>0</sub> <sup>(2)</sup> daN	F daN	(3)	kg
T-18300-10	10	110	100	18300 (20°C, 150 bar)	23200	No	8.66
T-18300-16	16	136	120		23800	No	9.13
T-18300-25	25	165	140		25200	No	10.69
T-18300-32	32	197	165		25100	No	12.41
T-18300-40	40	235	195		24900	No	14.46
T-18300-50	50	270	220		25400	No	16.34

(1) other strokes under request      (2) alternative forces upon request      (3) ESK under request



Pressure medium	N <sub>2</sub>	Working temperature	0-80°C	Min. security stroke	10%
Max. Charging pressure	150 bar	Temperature related force increase	+0.34%/°C	Repair Kit	KIT T-18300
Min. Charging pressure	25 bar	Max. working speed	0.5 m/s	Linkable	No

### Mounting possibilities

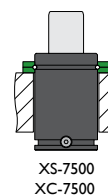
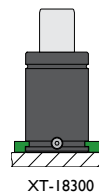
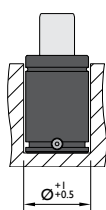
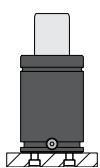

## Flanges



**XT-18300**

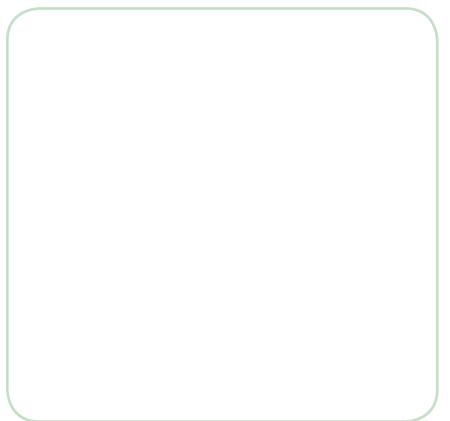
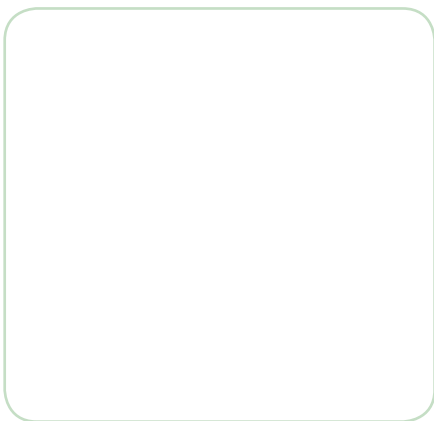

**XS-7500**

**XC-7500**

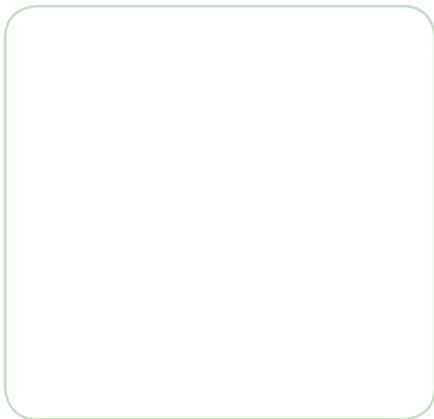

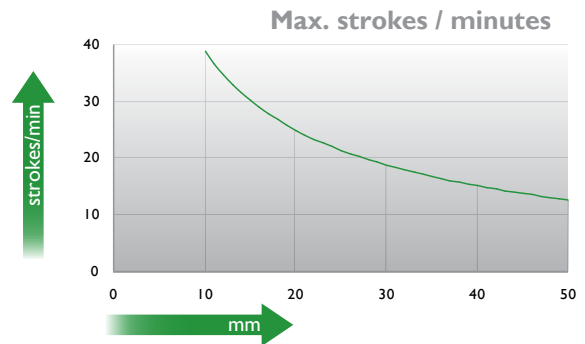
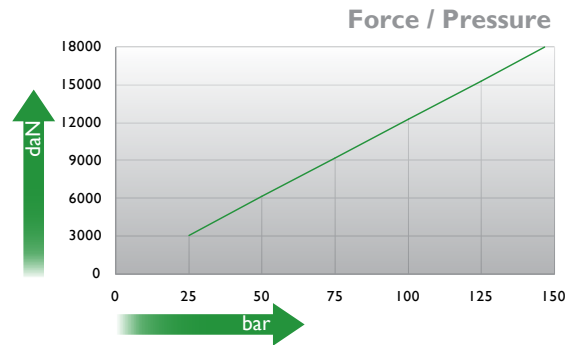
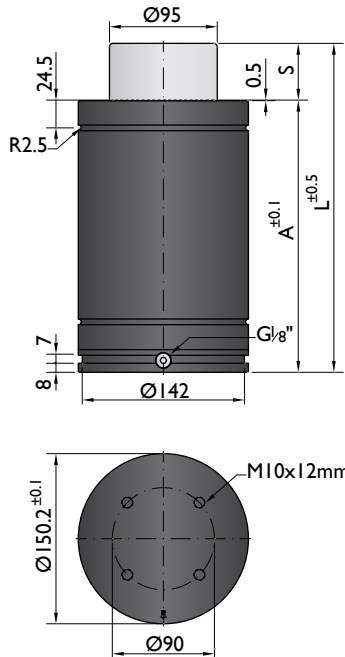

Ordering example: 4 x TC-18300-50

Order No.	S <sup>(1)</sup> mm	L mm	A mm	F <sub>0</sub> <sup>(2)</sup> daN (20°C, 150 bar)	F daN	 <sup>(3)</sup>	kg
TC-18300-10	10	130	120	18300	23200	No	11.36
TC-18300-16	16	156	140		23800	No	11.83
TC-18300-25	25	185	160		25200	No	13.39
TC-18300-32	32	217	185		25100	No	15.11
TC-18300-40	40	255	215		24900	No	17.16
TC-18300-50	50	290	240		25400	No	19.04

(1) other strokes under request      (2) alternative forces upon request      (3) ESK under request



Pressure medium	N <sub>2</sub>	Working temperature	0-80°C	Min. security stroke	10%
Max. Charging pressure	150 bar	Temperature related force increase	+0.34%/°C	Repair Kit	KIT TC-18300
Min. Charging pressure	25 bar	Max. working speed	0.5m/s	Linkable	G1/8"

### Mounting possibilities

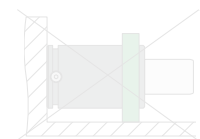
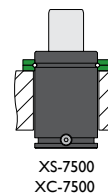
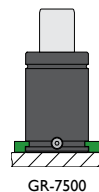
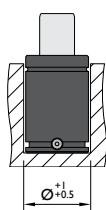
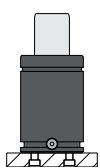

## Flanges



**GR-7500**

ISO

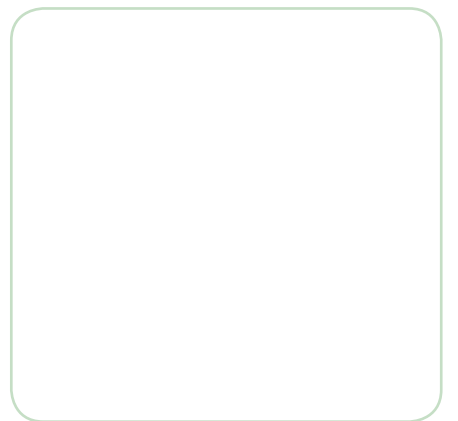
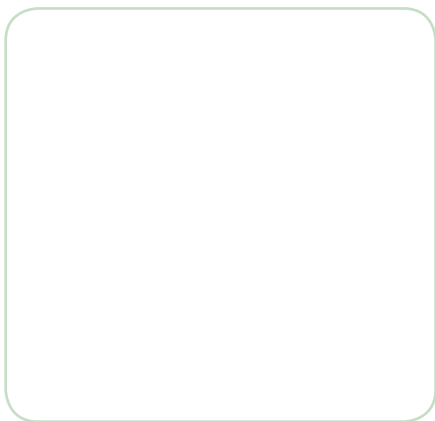

**XS-7500**

ISO

**XC-7500**

VDI  
ISO

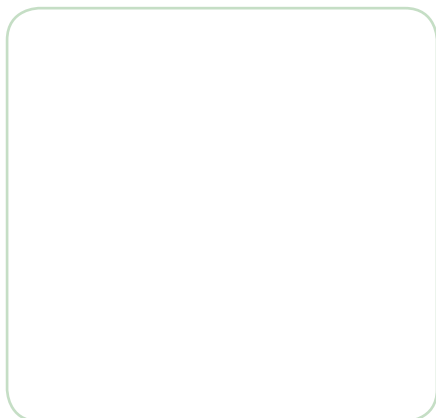

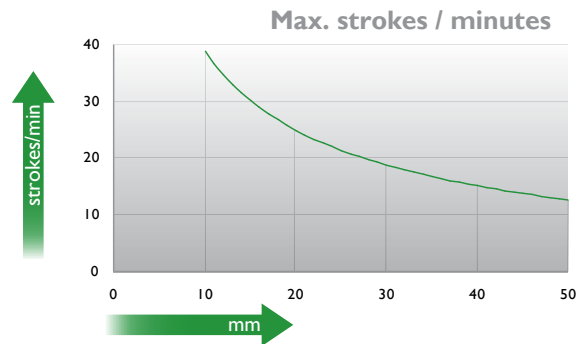
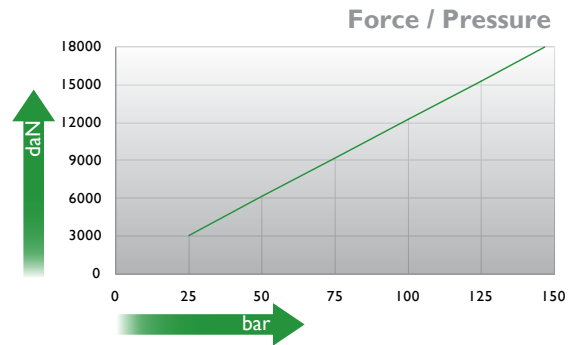
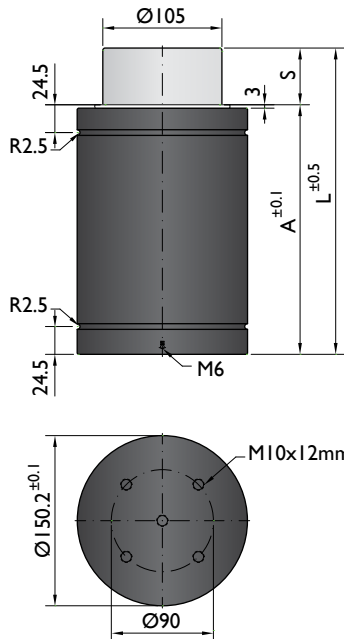

Ordering example: 4 x TS-18300-50

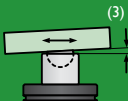
Order No.	S <sup>(1)</sup> mm	L mm	A mm	F <sub>0</sub> <sup>(2)</sup> daN (20°C, 150 bar)	F daN		kg
TS-18300-10	10	110	100	18300	23200	No	8.66
TS-18300-16	16	136	120		23800	No	9.13
TS-18300-25	25	165	140		25200	No	10.69
TS-18300-32	32	197	165		25100	No	12.41
TS-18300-40	40	235	195		24900	No	14.46
TS-18300-50	50	270	220		25400	No	16.34
TS-18300-65	65	323	258		25900	No	18.22

other strokes <sup>(1)</sup> under request

alternative forces <sup>(2)</sup> upon request

ESK <sup>(3)</sup> under request



Pressure medium	N <sub>2</sub>	Working temperature	0-80°C	Min. security stroke	10%
Max. Charging pressure	150 bar	Temperature related force increase	+0.34%/°C	Repair Kit	KIT TS-18300
Min. Charging pressure	25 bar	Max. working speed	0.5 m/s	Linkable	No

## Mounting possibilities

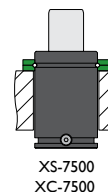
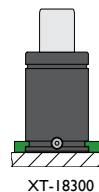
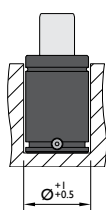
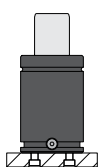

## Flanges



**XT-18300**

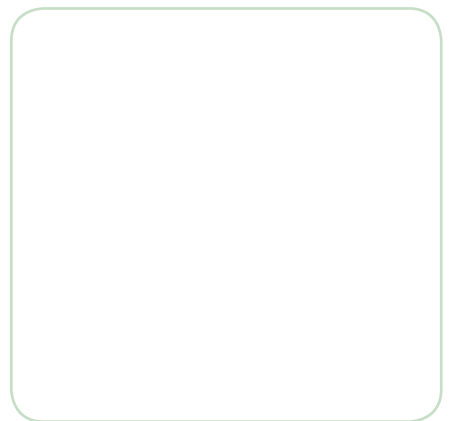
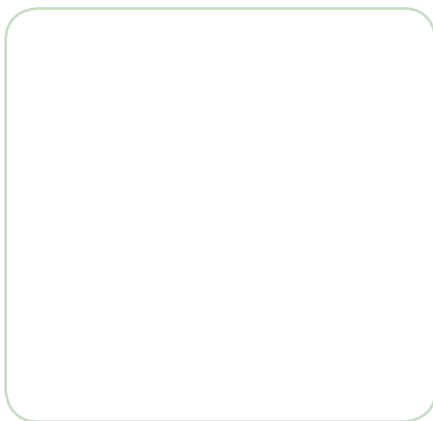

**XS-7500**

**XC-7500**



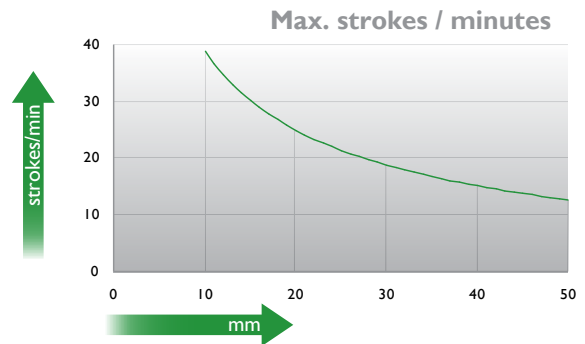
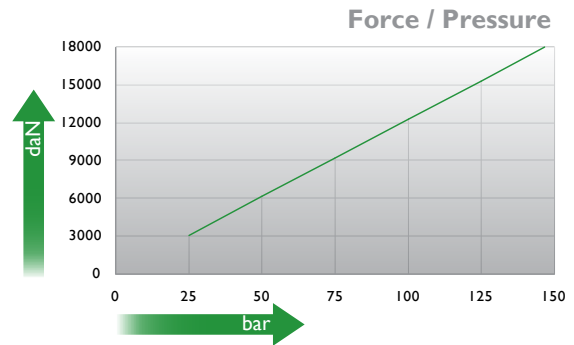
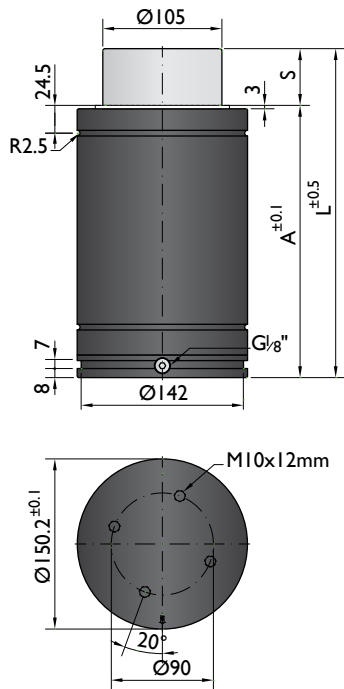

Ordering example: 4 x TSC-18300-50

Order No.	S <sup>(1)</sup> mm	L mm	A mm	F <sub>0</sub> <sup>(2)</sup> daN	F daN	ESK <sup>(3)</sup>	kg
TSC-18300-10	10	130	120	18300	23200	No	11.36
TSC-18300-16	16	156	140		23800	No	11.83
TSC-18300-25	25	185	160		25200	No	13.39
TSC-18300-32	32	217	185		25100	No	15.11
TSC-18300-40	40	255	215		24900	No	17.16
TSC-18300-50	50	290	240		25400	No	19.04
TSC-18300-65	65	343	278		25900	No	20.92

other strokes under request<sup>(1)</sup>

alternative forces upon request<sup>(2)</sup>

ESK under request<sup>(3)</sup>



Pressure medium	N <sub>2</sub>	Working temperature	0-80°C	Min. security stroke	10%
Max. Charging pressure	150 bar	Temperature related force increase	+0.34%/°C	Repair Kit	KIT TSC-18300
Min. Charging pressure	25 bar	Max. working speed	0.5 m/s	Linkable	G1/8"

### Mounting possibilities

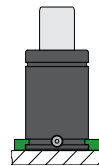
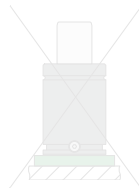
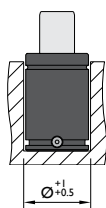
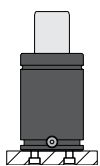

GR-7500

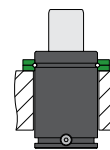

XS-7500  
XC-7500



## Flanges

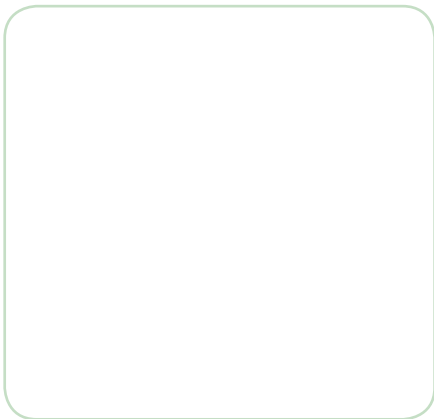
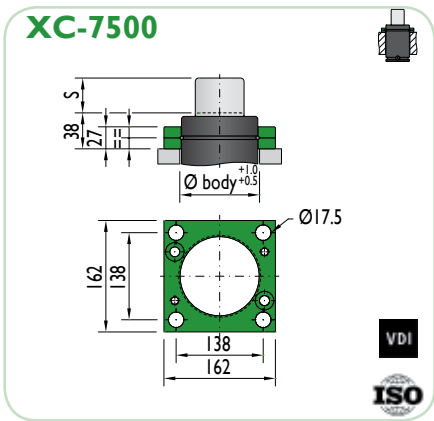
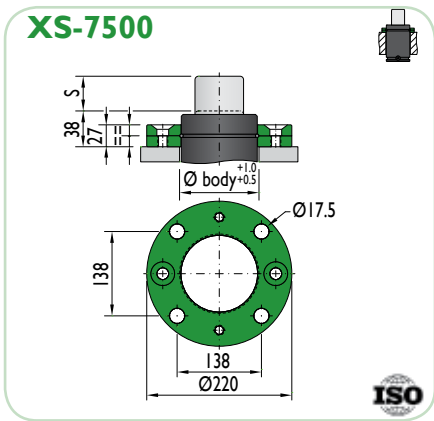
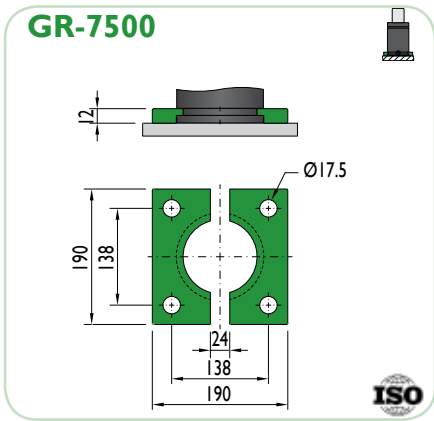



## Ejector Pin Units



**Standards**

<b>PED</b> 97/23/EC	<b>PED</b> 97/23/EC	<b>PED</b> 97/23/EC
ISO 11901	ISO 11901	ISO 11901
<b>VDI</b> 3004	<b>VDI</b> 3004	<b>VDI</b> 3004
CNOMO EM24.54.700	CNOMO EM24.54.700	CNOMO EM24.54.700

## Ejector Pin Units

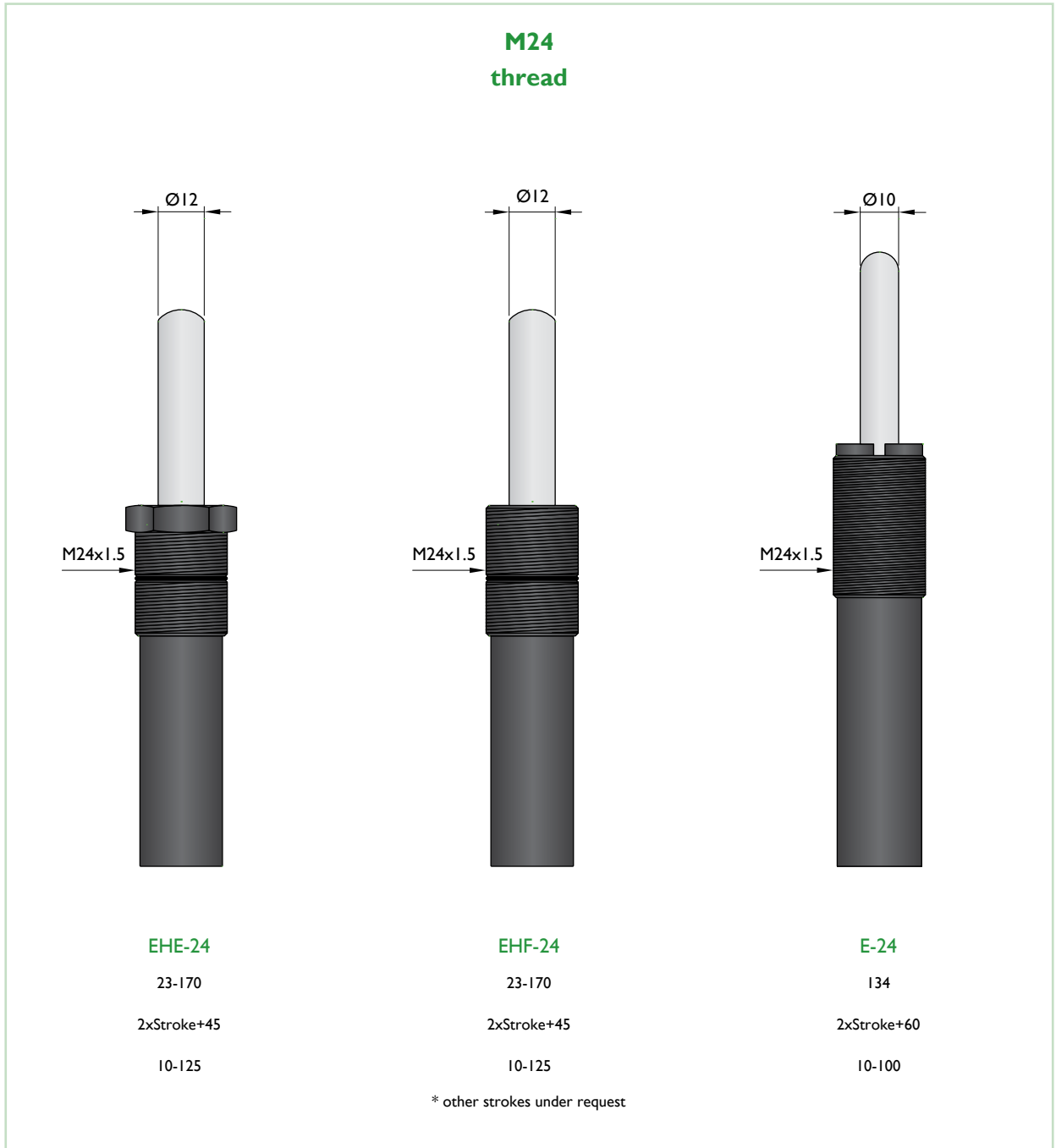

### Standards

<b>PED</b> 97/23/EC	<b>PED</b> 97/23/EC	<b>PED</b> 97/23/EC
<b>ISO</b> 11901	<b>ISO</b> 11901	<b>ISO</b> 11901
<b>VDI</b> 3004	<b>VDI</b> 3004	<b>VDI</b> 3004
<b>CNOMO</b> EM24.54.700	<b>CNOMO</b> EM24.54.700	<b>CNOMO</b> EM24.54.700

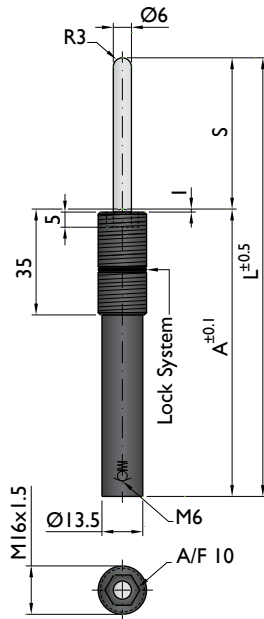

### Force / Pressure

		daN	bar (20°C)
V	GREEN	6	20
Z	BLUE	11	40
R	RED	21	75
A	YELLOW	42	150

\* maximum force if not specified

### Max. strokes / minutes

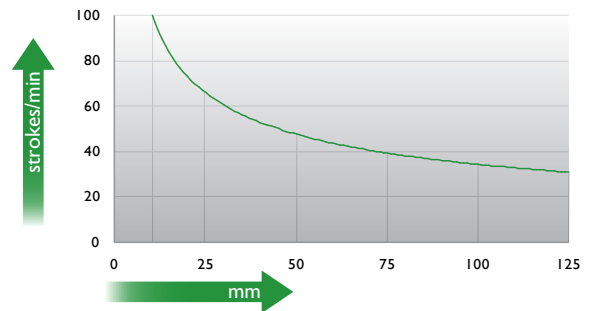

Ordering example: 4 x EHF-16-50 A

Order No.	S <sup>(1)</sup> mm	L mm	A mm	F <sub>0</sub> <sup>(2)</sup> daN (20°C, 150 bar)	
					F daN
EHF-16-10	10	65	55		73
EHF-16-20	20	85	65		66
EHF-16-30	30	105	75		64
EHF-16-40	40	125	85		64
EHF-16-50	50	145	95	42	67
EHF-16-60	60	165	105		66
EHF-16-70	70	185	115		65
EHF-16-80	80	205	125		65
EHF-16-100	100	245	145		64
EHF-16-125	125	295	170		64

<sup>(1)</sup> other strokes under request

<sup>(2)</sup> alternative forces upon request



Pressure medium	N <sub>2</sub>	Working temperature	0-80°C	Min. security stroke	10%
Max. Charging pressure	150 bar	Temperatura related force increase	+0.34%/°C	Repair Kit	Non-repairable
Min. Charging pressure	20 bar	Max. working speed	1.6 m/s	Linkable	No

### Mounting possibilities

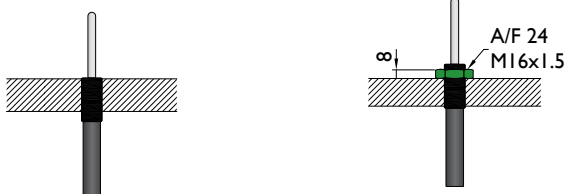

### Key

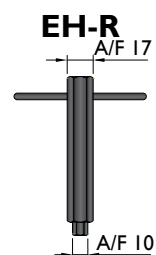

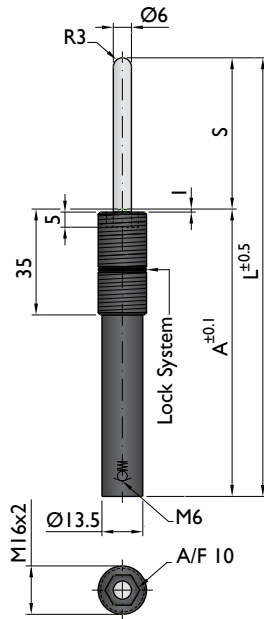

### Force / Pressure

		daN	bar (20°C)
V	GREEN	6	20
Z	BLUE	11	40
R	RED	21	75
A	YELLOW	42	150

\* maximum force if not specified

### Max. strokes / minutes

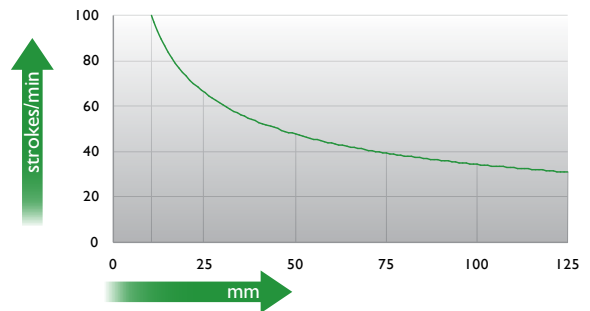

Ordering example: 4 x EHN-16-50 Z

Order No.	S <sup>(1)</sup> mm	L mm	A mm	F <sub>0</sub> <sup>(2)</sup> (20°C, 150 bar)	
				F <sub>0</sub> daN	F daN
EHN-16-10	10	65	55		73
EHN-16-20	20	85	65		66
EHN-16-30	30	105	75		64
EHN-16-40	40	125	85		64
EHN-16-50	50	145	95	42	67
EHN-16-60	60	165	105		66
EHN-16-70	70	185	115		65
EHN-16-80	80	205	125		65
EHN-16-100	100	245	145		64
EHN-16-125	125	295	170		64

<sup>(1)</sup> other strokes under request

<sup>(2)</sup> alternative forces upon request



Pressure medium	N <sub>2</sub>	Working temperature	0-80°C	Min. security stroke	10%
Max. Charging pressure	150 bar	Temperatura related force increase	+0.34%/°C	Repair Kit	Non-repairable
Min. Charging pressure	20 bar	Max. working speed	1.6 m/s	Linkable	No

### Mounting possibilities

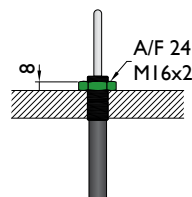
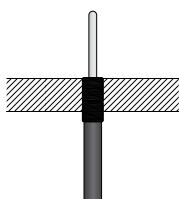

### Key

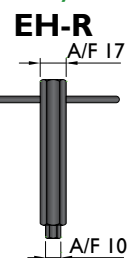

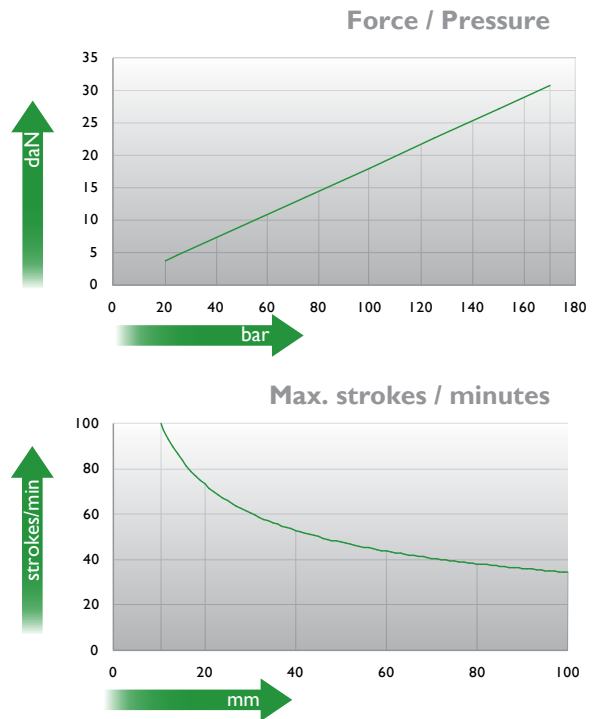
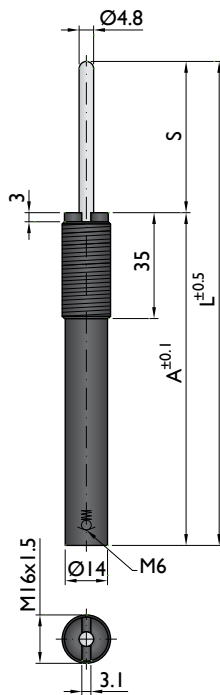

Ordering example: 4 x E-16-50

Order No.	S <sup>(1)</sup> mm	L mm	A mm	F <sub>0</sub> <sup>(2)</sup> daN (20°C, 170 bar)	
					F daN
E-16-10	10	80	70		34
E-16-20	20	100	80		35
E-16-30	30	120	90		36
E-16-40	40	140	100		36
E-16-50	50	160	110	31	36
E-16-60	60	180	120		37
E-16-70	70	200	130		37
E-16-80	80	220	140		37
E-16-100	100	260	160		38

<sup>(1)</sup> other strokes under request

<sup>(2)</sup> alternative forces upon request



Pressure medium	N <sub>2</sub>	Working temperature	0-80°C	Min. security stroke	10%
Max. Charging pressure	170 bar	Temperatura related force increase	+0.34%/°C	Repair Kit	Non-repairable
Min. Charging pressure	20 bar	Max. working speed	1.6 m/s	Linkable	No

### Mounting possibilities

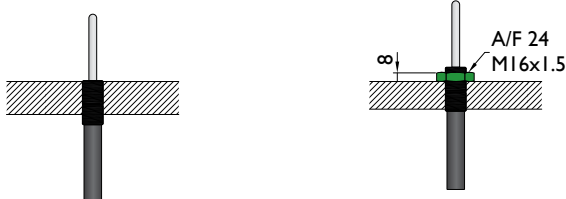

### Key

**E-16-R**

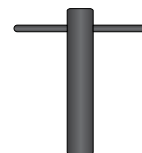

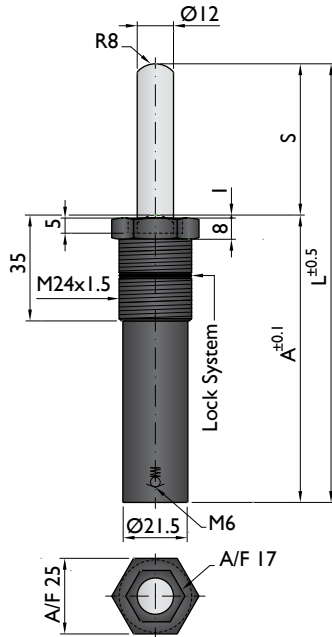

### Force / Pressure

		daN	bar (20°C)
V	GREEN	23	20
Z	BLUE	45	40
R	RED	85	75
A	YELLOW	170	150

\* maximum force if not specified

### Max. strokes / minutes

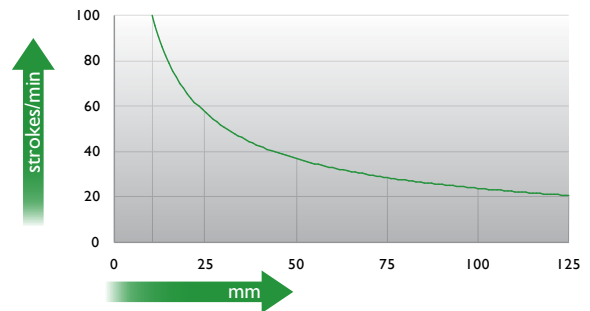

Ordering example: 4 x EHE-24-50 R

Order No.	S <sup>(1)</sup> mm	L mm	A mm	F <sub>0</sub> <sup>(2)</sup> (20°C, 150 bar)	
				daN	F daN
EHE-24-10	10	65	55		243
EHE-24-16	16	77	61		275
EHE-24-20	20	85	65		269
EHE-24-25	25	95	70		292
EHE-24-30	30	105	75		281
EHE-24-38	38	121	83		305
EHE-24-40	40	125	85	170	289
EHE-24-50	50	145	95		313
EHE-24-60	60	165	105		314
EHE-24-70	70	185	115		315
EHE-24-80	80	205	125		315
EHE-24-100	100	245	145		316
EHE-24-125	125	295	170		317

<sup>(1)</sup> other strokes under request

<sup>(2)</sup> alternative forces upon request



Pressure medium	N <sub>2</sub>	Working temperature	0-80°C	Min. security stroke	10%
Max. Charging pressure	150 bar	Temperatura related force increase	+0.34%/°C	Repair Kit	Non-repairable
Min. Charging pressure	20 bar	Max. working speed	1.6 m/s	Linkable	No

### Mounting possibilities

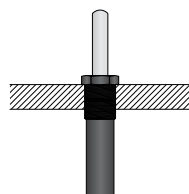

### Key

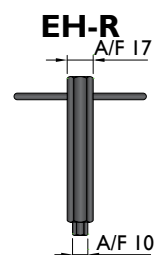

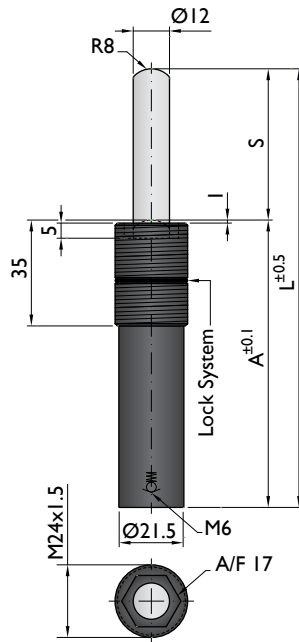

### Force / Pressure

		daN	bar (20°C)
V	GREEN	23	20
Z	BLUE	45	40
R	RED	85	75
A	YELLOW	170	150

\* maximum force if not specified

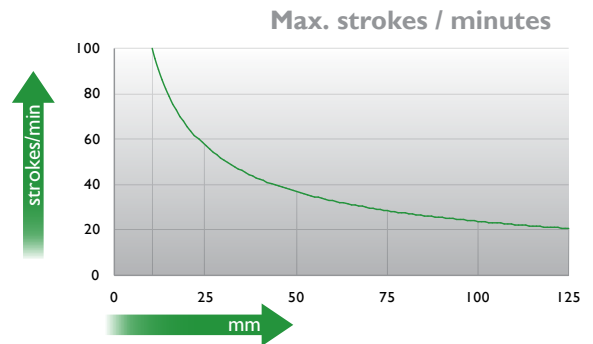

Ordering example: 4 x EHF-24-50 V

Order No.	S <sup>(1)</sup> mm	L mm	A mm	F <sub>0</sub> <sup>(2)</sup> daN (20°C, 150 bar)	
					F daN
EHF-24-10	10	65	55		245
EHF-24-20	20	85	65		269
EHF-24-30	30	105	75		282
EHF-24-40	40	125	85		291
EHF-24-50	50	145	95	170	314
EHF-24-60	60	165	105		314
EHF-24-70	70	185	115		316
EHF-24-80	80	205	125		316
EHF-24-100	100	245	145		318
EHF-24-125	125	295	170		318

<sup>(1)</sup> other strokes under request

<sup>(2)</sup> alternative forces upon request



Pressure medium	N <sub>2</sub>	Working temperature	0-80°C	Min. security stroke	10%
Max. Charging pressure	150 bar	Temperatura related force increase	+0.34%/°C	Repair Kit	Non-repairable
Min. Charging pressure	20 bar	Max. working speed	1.6 m/s	Linkable	No

### Mounting possibilities

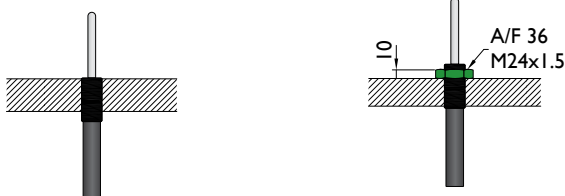

### Key

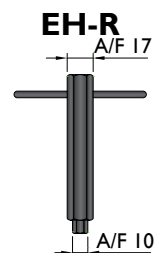

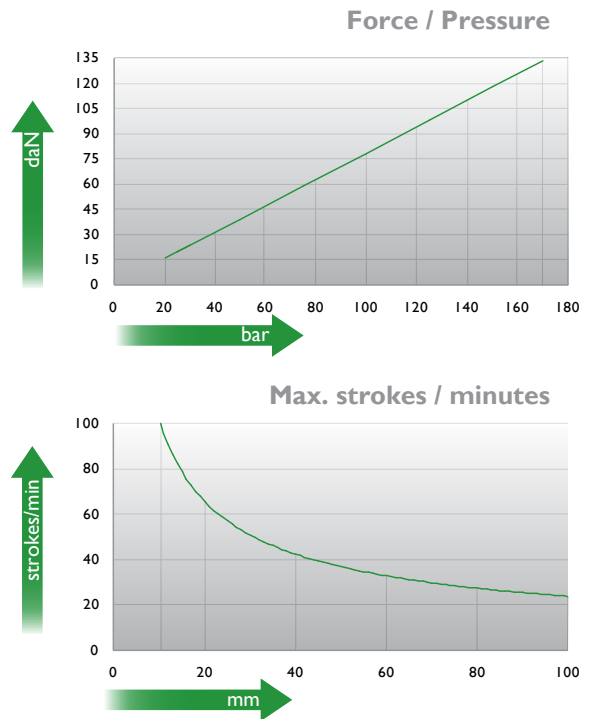
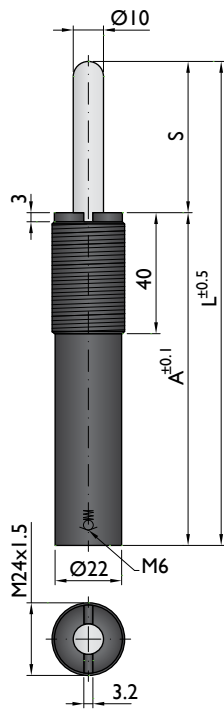

Ordering example: 4 x E-24-50

Order No.	S <sup>(1)</sup> mm	L mm	A mm	F <sub>0</sub> <sup>(2)</sup> daN	
				(20°C, 170 bar)	F daN
E-24-10	10	80	70		152
E-24-20	20	100	80		161
E-24-30	30	120	90		168
E-24-40	40	140	100		172
E-24-50	50	160	110	134	175
E-24-60	60	180	120		177
E-24-70	70	200	130		179
E-24-80	80	220	140		180
E-24-100	100	260	160		182

<sup>(1)</sup> other strokes under request

<sup>(2)</sup> alternative forces upon request



Pressure medium	N <sub>2</sub>	Working temperature	0-80°C	Min. security stroke	10%
Max. Charging pressure	170 bar	Temperatura related force increase	+0.34%/°C	Repair Kit	Non-repairable
Min. Charging pressure	20 bar	Max. working speed	1.6 m/s	Linkable	No

### Mounting possibilities

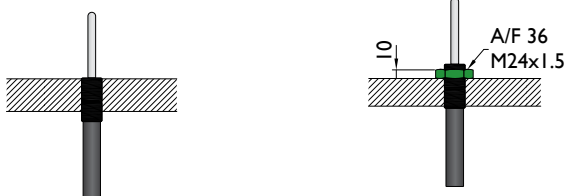

### Key

**E-24-R**

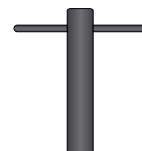







## Spring Plunger Selection Guide

THREADED

Model	Description	Ø	S mm	Page
E-201	 With ball and slot	M2 - M24	0.3 - 5.5	288
E-202	 With internal hexagon	M3 - M24	1 - 10	289
E-205	 With ball and internal hexagon	M3 - M24	0.4 - 5.5	292
E-206	 Plastic	M6 - M10	0.9 - 1.9	293
E-207	 With pin and internal hexagon	M4 - M24	1.5 - 8	294
E-208	 With pin and slot	M4 - M24	1.5 - 8	295
E-209	 With internal hexagon and seal	M8 - M16	3 - 5	296

SMOOTH

E-203	 Smooth	Ø6 - Ø12	3.5 - 6.5	290
E-204	 Smooth with collar and ball	Ø3 - Ø12	0.55 - 4	291
E-210	 Smooth without collar	Ø2 - Ø6	0.3 - 1.5	297

## Spring Plunger with ball and slot

FINISH

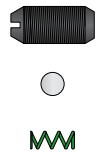

FI	F2	F3	F4
Free cutting steel, blackened	Free cutting steel, blackened	Stainless steel 1.4305	Stainless steel 1.4305
Ball-bearing steel, hardened	Ball-bearing steel, hardened	Stainless steel, hardened	Stainless steel, hardened
Stainless steel, standard spring load	Stainless steel, heavy spring load	Stainless steel, standard spring load	Stainless steel, heavy spring load

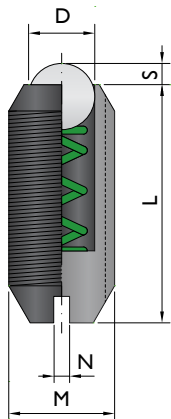

Order No.	M	S mm	D mm	L mm	N mm	F S=0 N	F Smax N
E-201-03	M 3	0.4	1.5	7	0.40	3	4.5
E-201-04	M 4	0.8	2.5	9	0.6	8.5	14
E-201-05	M 5	0.9	3	12	0.8	8	14
E-201-06	M 6	1	3.5	14	1	11	18
E-201-08	M 8	1.5	4.5	16	1.2	18	31
E-201-10	M10	2	6	19	1.5	24	45
E-201-12	M12	2.5	8	22	2	26	49
E-201-16	M16	3.5	10	24	2	41	86
E-201-20	M20	4.5	12	30	2.5	56	111
E-201-24	M24	5.5	15	34	3	81	151
E-201-05	M 5	0.9	3	12	0.8	15	22
E-201-06	M 6	1	3.5	14	1	19	28
E-201-08	M 8	1.5	4.5	16	1.2	36	62
E-201-10	M10	2	6	19	1.5	57	104
E-201-12	M12	2.5	8	22	2	61	110
E-201-16	M16	3.5	10	24	2	68	142
E-201-20	M20	4.5	12	30	2.5	84	166
E-201-24	M24	5.5	15	34	3	127	237
E-201-02	M 2	0.3	1	4	0.25	0.8	1.5
E-201-03	M 3	0.4	1.5	7	0.4	3	4.5
E-201-04	M 4	0.8	2.5	9	0.6	8.5	14
E-201-05	M 5	0.9	3	12	0.8	8	14
E-201-06	M 6	1	3.5	14	1	11	18
E-201-08	M 8	1.5	4.5	16	1.2	18	31
E-201-10	M10	2	6	19	1.5	24	45
E-201-12	M12	2.5	8	22	2	26	49
E-201-16	M16	3.5	10	24	2	41	86
E-201-20	M20	4.5	12	30	2.5	56	111
E-201-24	M24	5.5	15	34	3	81	151
E-201-05	M 5	0.9	3	12	0.8	15	22
E-201-06	M 6	1	3.5	14	1	19	28
E-201-08	M 8	1.5	4.5	16	1.2	36	62
E-201-10	M10	2	6	19	1.5	57	104
E-201-12	M12	2.5	8	22	2	61	110
E-201-16	M16	3.5	10	24	2	68	142
E-201-20	M20	4.5	12	30	2.5	84	166
E-201-24	M24	5.5	15	34	3	127	237

Ordering example: 4 x E-201-05-F3

## Spring Plunger with internal hexagon

FINISH

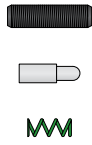

F1	F2	F3	F4	F5
Free cutting steel, blackened	Free cutting steel, blackened	Free cutting steel, blackened	Stainless steel 1.4305	Stainless steel 1.4305
Free cutting steel, hardened, blackened	Free cutting steel, hardened, blackened	Thermoplastic POM, white	Thermoplastic POM, white	Stainless steel 1.4305
Stainless steel, standard spring load	Stainless steel, heavy spring load	Stainless steel, standard spring load	Stainless steel, standard spring load	Stainless steel, standard spring load

Order No.	M	S mm	D mm	L mm	A/F	N mm	T mm	F S=0 N	F Smax N
E-202-03	M 3	1	1	12	0.7	0.4	0.5	2	4
E-202-04	M 4	1.5	1.5	15	1.3	0.6	0.6	4.5	16
E-202-05	M 5	2.3	2.4	18	1.5	1.2	0.8	6	19
E-202-06	M 6	2.5	2.7	20	2	1.3	0.9	6	19
E-202-08	M 8	3	3.5	22	2.5	1.5	1.4	10	39
E-202-10	M10	3	4	22	3	1.5	1.4	10	39
E-202-12	M12	4	6	28	4	2.7	2	12	53
E-202-16	M16	5	7.5	32	5	3.2	2.5	45	100
E-202-20	M20	7	10	40	6	3.7	3	52	125
E-202-24	M24	10	12	52	8	3.7	3	70	170
E-202-05	M 5	2.3	2.4	18	1.5	1.2	0.8	11	40
E-202-06	M 6	2.5	2.7	20	2	1.3	0.9	15	43
E-202-08	M 8	3	3.5	22	2.5	1.5	1.4	20	75
E-202-10	M10	3	4	22	3	1.5	1.4	20	75
E-202-12	M12	4	6	28	4	2.7	2	45	120
E-202-16	M16	5	7.5	32	5	3.2	2.5	64	160
E-202-20	M20	7	10	40	6	3.7	3	75	195
E-202-24	M24	10	12	52	8	3.7	3	75	245
E-202-04	M 4	1.5	1.5	15	1.3	0.6	0.6	4.5	16
E-202-05	M 5	2.3	2.4	18	1.5	1.2	0.8	6	19
E-202-06	M 6	2.5	2.7	20	2	1.3	0.9	6	19
E-202-08	M 8	3	3.5	22	2.5	1.5	1.4	10	39
E-202-10	M10	3	4	22	3	1.5	1.4	10	39
E-202-12	M12	4	6	28	4	2.7	2	12	53
E-202-16	M16	5	7.5	32	5	3.2	2.5	45	100
E-202-04	M 4	1.5	1.5	15	1.3	0.6	0.6	4.5	16
E-202-05	M 5	2.3	2.4	18	1.5	1.2	0.8	6	19
E-202-06	M 6	2.5	2.7	20	2	1.3	0.9	6	19
E-202-08	M 8	3	3.5	22	2.5	1.5	1.4	10	39
E-202-10	M10	3	4	22	3	1.5	1.4	10	39
E-202-12	M12	4	6	28	4	2.7	2	12	53
E-202-16	M16	5	7.5	32	5	3.2	2.5	45	100
E-202-04	M 4	1.5	1.5	15	1.3	0.6	0.6	4.5	16
E-202-05	M 5	2.3	2.4	18	1.5	1.2	0.8	6	19
E-202-06	M 6	2.5	2.7	20	2	1.3	0.9	6	19
E-202-08	M 8	3	3.5	22	2.5	1.5	1.4	10	39
E-202-10	M10	3	4	22	3	1.5	1.4	10	39
E-202-12	M12	4	6	28	4	2.7	2	12	53
E-202-16	M16	5	7.5	32	5	3.2	2.5	45	100
E-202-04	M 4	1.5	1.5	15	1.3	0.6	0.6	4.5	16
E-202-05	M 5	2.3	2.4	18	1.5	1.2	0.8	6	19
E-202-06	M 6	2.5	2.7	20	2	1.3	0.9	6	19
E-202-08	M 8	3	3.5	22	2.5	1.5	1.4	10	39
E-202-10	M10	3	4	22	3	1.5	1.4	10	39
E-202-12	M12	4	6	28	4	2.7	2	12	53
E-202-16	M16	5	7.5	32	5	3.2	2.5	45	100
E-202-20	M20	7	10	40	6	3.7	3	52	125

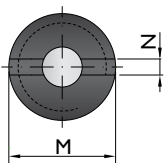
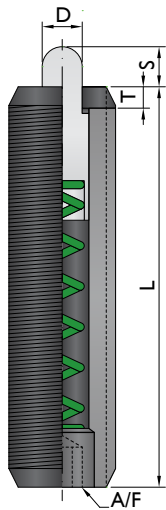



See keys on page 316.

Ordering example: 4 x E-202-05-F3

## Smooth Spring plunger

FINISH



FI	
	Free cutting steel, blackened
	Steel, case-hardened, blackened
	Stainless steel

Order No.		D <sub>1</sub> mm	S mm	D <sub>2</sub> mm	D <sub>3</sub> mm	L <sub>1</sub> mm	L <sub>2</sub> mm	L <sub>3</sub> mm	F S=0 N	F Smax N
E-203-06	FI	6	3.5	2.7	8	20	3.2	6	10	22
E-203-08		8	4.5	3.9	10	24	3.2	8	30	88
E-203-10		10	5.5	5.9	13	30	4	10	42	110
E-203-12		12	6.5	7.9	16	36	5	12	50	130

Ordering example: 4 x E-203-06-FI

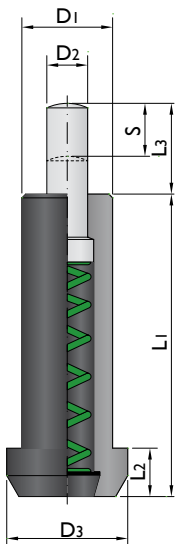

## Smooth Spring Plunger with collar and ball

FINISH

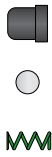

	F1	F2	F3	F4
	Thermoplastic POM, blue	Thermoplastic POM, blue	Brass	Stainless steel I.4303
	Thermoplastic POM, white	Stainless steel, hardened	Stainless steel, hardened	Stainless steel, hardened
	Stainless steel	Stainless steel	Stainless steel	Stainless steel

Order No.	D <sub>1</sub> mm	S mm	D <sub>2</sub> mm	D <sub>3</sub> mm	L <sub>1</sub> mm	L <sub>2</sub> mm	F S=0 N	F Smax N
E-204-04	4	0.8	3	4.6	5	1	3	6.5
E-204-05	5	1	4	5.6	6	1	6	9.4
E-204-06	6	1.6	5	6.5	7	1	6.2	12.6
E-204-08	8	1.9	6.5	8.5	9	1	10	20.4
E-204-10	10	2.4	8	11	13.5	1.5	11.9	22.3
E-204-12	12	3.3	10	13	16	1.5	14	25
E-204-03	3	0.55	2	3.6	4	0.6	1.7	3.5
E-204-04	4	0.8	3	4.6	5	1	3	6.5
E-204-05	5	1	4	5.6	6	1	6	9.4
E-204-06	6	1.6	5	6.5	7	1	6.2	12.6
E-204-08	8	1.9	6.5	8.5	9	1	10	20.4
E-204-10	10	2.4	8	11	13.5	1.5	11.9	22.3
E-204-12	12	3.3	10	13	16	1.5	14	25
E-204-03	3	0.6	2.38	3.6	4	0.6	1.8	3.5
E-204-04	4	0.8	3	4.5	5	1	3	6
E-204-05	5	1	4	5.5	6	1	4	6.5
E-204-06	6	1.6	5	6.5	7	1	6	11.5
E-204-08	8	1.9	6.5	8.5	9	1	8	12.5
E-204-03	3	0.7	2.38	3.5	4	0.75	1.8	3.5
E-204-04	4	1	3	4.6	5	0.9	2.5	6
E-204-05	5	1.4	4	5.6	6	0.9	3	6.5
E-204-06	6	1.8	5	6.5	7	1	5.5	11.5
E-204-08	8	2.4	6.5	8.5	9	1.1	7	12.5
E-204-10	10	3.3	8.5	11	13	1.5	8.5	18.5
E-204-12	12	4	10	13	16	2.3	12	26.5

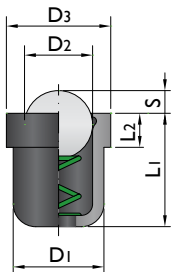

Ordering example: 4 x E-204-04-F2



## Spring Plunger with ball and internal hexagon

FINISH



F1	F2	F3	F4
Free cutting steel, blackened	Free cutting steel, blackened	Stainless steel 1.4305	Stainless steel 1.4305
Ball-bearing steel, hardened	Ball-bearing steel, hardened	Stainless steel, hardened	Stainless steel, hardened
Stainless steel, standard spring load	Stainless steel, heavy spring load	Stainless steel, standard spring load	Stainless steel, heavy spring load

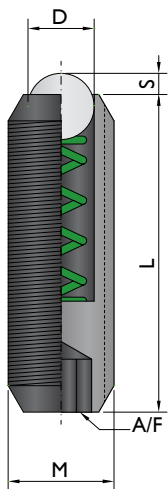

Order No.	M	S mm	D mm	L mm	A/F	F S=0 N	F Smax N
E-205-03	M 3	0.4	1.5	8	1.5	3	4.5
E-205-04	M 4	0.8	2.5	12	2	8.5	14
E-205-05	M 5	0.9	3	14	2.5	8	14
E-205-06	M 6	1	3.5	15	3	11	18
E-205-08	M 8	1.5	4.5	18	4	18	31
E-205-10	M10	2	6	23	5	24	45
E-205-12	M12	2.5	8	26	6	26	49
E-205-16	M16	3.5	10	33	8	41	86
E-205-20	M20	4.5	12	43	10	56	111
E-205-24	M24	5.5	15	48	12	81	151
E-205-05	M 5	0.9	3	14	2.5	15	22
E-205-06	M 6	1	3.5	15	3	19	28
E-205-08	M 8	1.5	4.5	18	4	36	62
E-205-10	M10	2	6	23	5	57	104
E-205-12	M12	2.5	8	26	6	61	110
E-205-16	M16	3.5	10	33	8	68	142
E-205-20	M20	4.5	12	43	10	84	166
E-205-24	M24	5.5	15	48	12	127	237
E-205-03	M 3	0.4	1.5	8	1.5	3	4.5
E-205-04	M 4	0.8	2.5	12	2	8.5	14
E-205-05	M 5	0.9	3	14	2.5	8	14
E-205-06	M 6	1	3.5	15	3	11	18
E-205-08	M 8	1.5	4.5	18	4	18	31
E-205-10	M10	2	6	23	5	24	45
E-205-12	M12	2.5	8	26	6	26	49
E-205-16	M16	3.5	10	33	8	41	86
E-205-20	M20	4.5	12	43	10	56	111
E-205-24	M24	5.5	15	48	12	81	151
E-205-05	M 5	0.9	3	14	2.5	15	22
E-205-06	M 6	1	3.5	15	3	19	28
E-205-08	M 8	1.5	4.5	18	4	36	62
E-205-10	M10	2	6	23	5	57	104
E-205-12	M12	2.5	8	26	6	61	110
E-205-16	M16	3.5	10	33	8	68	142
E-205-20	M20	4.5	12	43	10	84	166
E-205-24	M24	5.5	15	48	12	127	237

Ordering example: 4 x E-205-03-F3

## Plastic Spring Plunger

FINISH

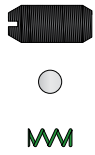

	F1	F2
	Thermoplastic POM, blue	Thermoplastic POM, blue
	Thermoplastic POM, white	Stainless steel, hardened
	Stainless steel	Stainless steel

Order No.		M	S mm	D mm	L mm	N mm	F S=0 N	F Smax N
E-206-06		M 6	0.9	3.5	14	1	12	17
E-206-08	F1	M 8	1.5	5	16	1.2	20	35
E-206-10		M10	1.9	6	19	1.5	25	45
E-206-06		M 6	0.9	3.5	14	1	12	17
E-206-08	F2	M 8	1.5	5	16	1.2	20	35
E-206-10		M10	1.9	6	19	1.5	25	45

Ordering example: 4 x E-206-06-F1

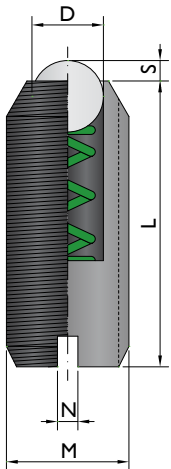



## Spring Plunger with pin and internal hexagon

FINISH



FI	F2	F3	F4
Free cutting steel, blackened	Free cutting steel, blackened	Stainless steel I.4305	Stainless steel I.4305
Free cutting steel, hardened, blackened	Free cutting steel, hardened, blackened	Stainless steel I.4305	Stainless steel I.4305
Stainless steel, standard spring load	Stainless steel, heavy spring load	Stainless steel, standard spring load	Stainless steel, heavy spring load

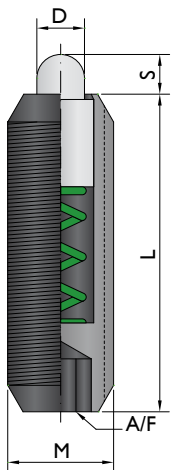

Order No.	M	S mm	D mm	L mm	A/F	F S=0 N	F Smax N
E-207-04	M 4	1.5	1.8	12	2	4.5	12.5
E-207-05	M 5	2	2.4	14	2.5	5	13
E-207-06	M 6	2	2.7	15	3	6	17
E-207-08	M 8	2	3.8	18	4	16	33
E-207-10	FI M10	2.5	4.5	23	5	19	42
E-207-12	M12	3.5	6.2	26	6	22	57
E-207-16	M16	4.5	8.5	33	8	38	78
E-207-20	M20	6.5	10	43	10	39	81
E-207-24	M24	8	13	48	12	72	155
E-207-06	M 6	2	2.7	15	3	11	25
E-207-08	M 8	2	3.8	18	4	23	59
E-207-10	M10	2.5	4.5	23	5	20	54
E-207-12	F2 M12	3.5	6.2	26	6	38	96
E-207-16	M16	4.5	8.5	33	8	50	100
E-207-20	M20	6.5	10	43	10	52	133
E-207-24	M24	8	13	48	12	91	223
E-207-04	M 4	1.5	1.8	12	2	4.5	12.5
E-207-05	M 5	2	2.4	14	2.5	5	13
E-207-06	M 6	2	2.7	15	3	6	17
E-207-08	M 8	2	3.8	18	4	16	33
E-207-10	F3 M10	2.5	4.5	23	5	19	42
E-207-12	M12	3.5	6.2	26	6	22	57
E-207-16	M16	4.5	8.5	33	8	38	78
E-207-20	M20	6.5	10	43	10	39	81
E-207-24	M24	8	13	48	12	72	155
E-207-06	M 6	2	2.7	15	3	11	25
E-207-08	M 8	2	3.8	18	4	23	59
E-207-10	M10	2.5	4.5	23	5	20	54
E-207-12	F4 M12	3.5	6.2	26	6	38	96
E-207-16	M16	4.5	8.5	33	8	50	100
E-207-20	M20	6.5	10	43	10	52	133
E-207-24	M24	8	13	48	12	91	223

Ordering example: 4 x E-207-06-F3

## Spring Plunger with pin and slot

FINISH



FI	F2	F3	F4
Free cutting steel, blackened	Free cutting steel, blackened	Stainless steel I.4305	Stainless steel I.4305
Free cutting steel, hardened, blackened	Free cutting steel, hardened, blackened	Stainless steel I.4305	Stainless steel I.4305
Stainless steel, standard spring load	Stainless steel, heavy spring load	Stainless steel, standard spring load	Stainless steel, heavy spring load

Order No.	M	S mm	D mm	L mm	N mm	F S=0 N	F Smax N
E-208-04	M 4	1.5	1.8	9	0.6	4.5	12.5
E-208-05	M 5	2	2.4	12	0.8	5	13
E-208-06	M 6	2	2.7	14	1	6	17
E-208-08	M 8	2	3.8	16	1.2	16	33
E-208-10	FI M10	2.5	4.5	19	1.5	19	42
E-208-12	M12	3.5	6.2	22	2	22	57
E-208-16	M16	4.5	8.5	24	2	38	78
E-208-20	M20	6.5	10	30	2.5	39	81
E-208-24	M24	8	13	34	3	72	155
E-208-06	M 6	2	2.7	14	1	11	25
E-208-08	M 8	2	3.8	16	1.2	23	59
E-208-10	M10	2.5	4.5	19	1.5	20	54
E-208-12	F2 M12	3.5	6.2	22	2	38	96
E-208-16	M16	4.5	8.5	24	2	50	100
E-208-20	M20	6.5	10	30	2.5	52	133
E-208-24	M24	8	13	34	3	91	223
E-208-04	M 4	1.5	1.8	9	0.6	4.5	12.5
E-208-05	M 5	2	2.4	12	0.8	5	13
E-208-06	M 6	2	2.7	14	1	6	17
E-208-08	M 8	2	3.8	16	1.2	16	33
E-208-10	F3 M10	2.5	4.5	19	1.5	19	42
E-208-12	M12	3.5	6.2	22	2	22	57
E-208-16	M16	4.5	8.5	24	2	38	78
E-208-20	M20	6.5	10	30	2.5	39	81
E-208-24	M24	8	13	34	3	72	155
E-208-06	M 6	2	2.7	14	1	11	25
E-208-08	M 8	2	3.8	16	1.2	23	59
E-208-10	M10	2.5	4.5	19	1.5	20	54
E-208-12	F4 M12	3.5	6.2	22	2	38	96
E-208-16	M16	4.5	8.5	24	2	50	100
E-208-20	M20	6.5	10	30	2.5	52	133
E-208-24	M24	8	13	34	3	91	223

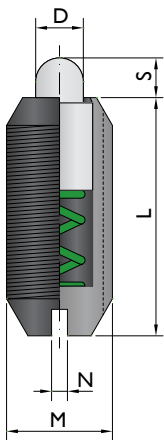

Ordering example: 4 x E-208-05-F3

## Spring Plunger with internal hexagon and seal

FINISH

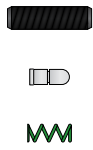

FI	F2	F3
Free cutting steel, blackened	Free cutting steel, blackened	Stainless steel I.4305
Free cutting steel, hardened, blackened	Free cutting steel, hardened, blackened	Stainless steel I.4305
Stainless steel, standard spring load	Stainless steel, heavy spring load	Stainless steel, standard spring load

Order No.	M	S mm	D mm	L mm	A/F	N mm	T mm	F S=0 N	F Smax N
E-209-08	M 8	3	3.8	26	2.5	1.5	1.4	9	24
E-209-10	M10	3.5	4	28	3	1.5	1.4	15	30
E-209-12	M12	4	6	35	4	2.7	2	24	50
E-209-16	M16	5	7.5	40	5	3.2	2.5	36	58
E-209-08	M 8	3	3.8	26	2.5	1.5	1.4	17	39
E-209-10	M10	3.5	4	28	3	1.5	1.4	22	43
E-209-12	M12	4	6	35	4	2.7	2	40	80
E-209-16	M16	5	7.5	40	5	3.2	2.5	44	113
E-209-08	M 8	3	3.8	26	2.5	1.5	1.4	9	24
E-209-10	M10	3.5	4	28	3	1.5	1.4	15	30
E-209-12	M12	4	6	35	4	2.7	2	24	50
E-209-16	M16	5	7.5	40	5	3.2	2.5	36	58

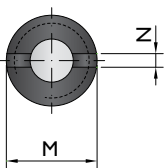
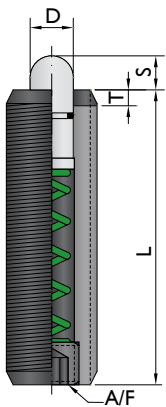

Ordering example: 4 x E-209-08-F3

See keys on page 316.

## Smooth Spring Plunger without collar

FINISH

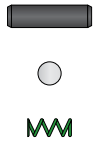

FI	
	Stainless steel 1.4305
	Stainless steel, hardened
	Stainless steel

Order No.		D <sub>1</sub> mm	S mm	D <sub>2</sub> mm	L mm	F S=0 N	F Smax N
E-210-020		2	0.3	1	3.5	0.8	1.5
E-210-025		2.5	0.4	1.5	5	2.8	4.7
E-210-030		3	0.65	2	7	4.5	7.5
E-210-035		3.5	0.8	2.5	9	6	14.5
E-210-040	FI	4	0.9	3	11	8	14
E-210-045		4.5	0.95	3.2	12	9.5	16.5
E-210-050		5	1	3.5	13	11	18
E-210-055		5.5	1.2	4	14	15.5	25
E-210-060		6	1.5	4.5	15	18	31

Ordering example: 4 x E-210-04-FI

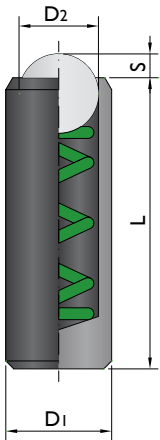



## Linking system selection

Linking gas springs allows to monitor and adjust pressure as well as charge and discharge the gas springs from outside the die. It also ensures a balanced force among several gas springs (with similar technical features).

NITROGAS offers various types of hoses, adapters and control panels to design a customized linked system. Those components are divided into 3 different systems: Micro Systems, EO24 Systems and Minimes Systems.

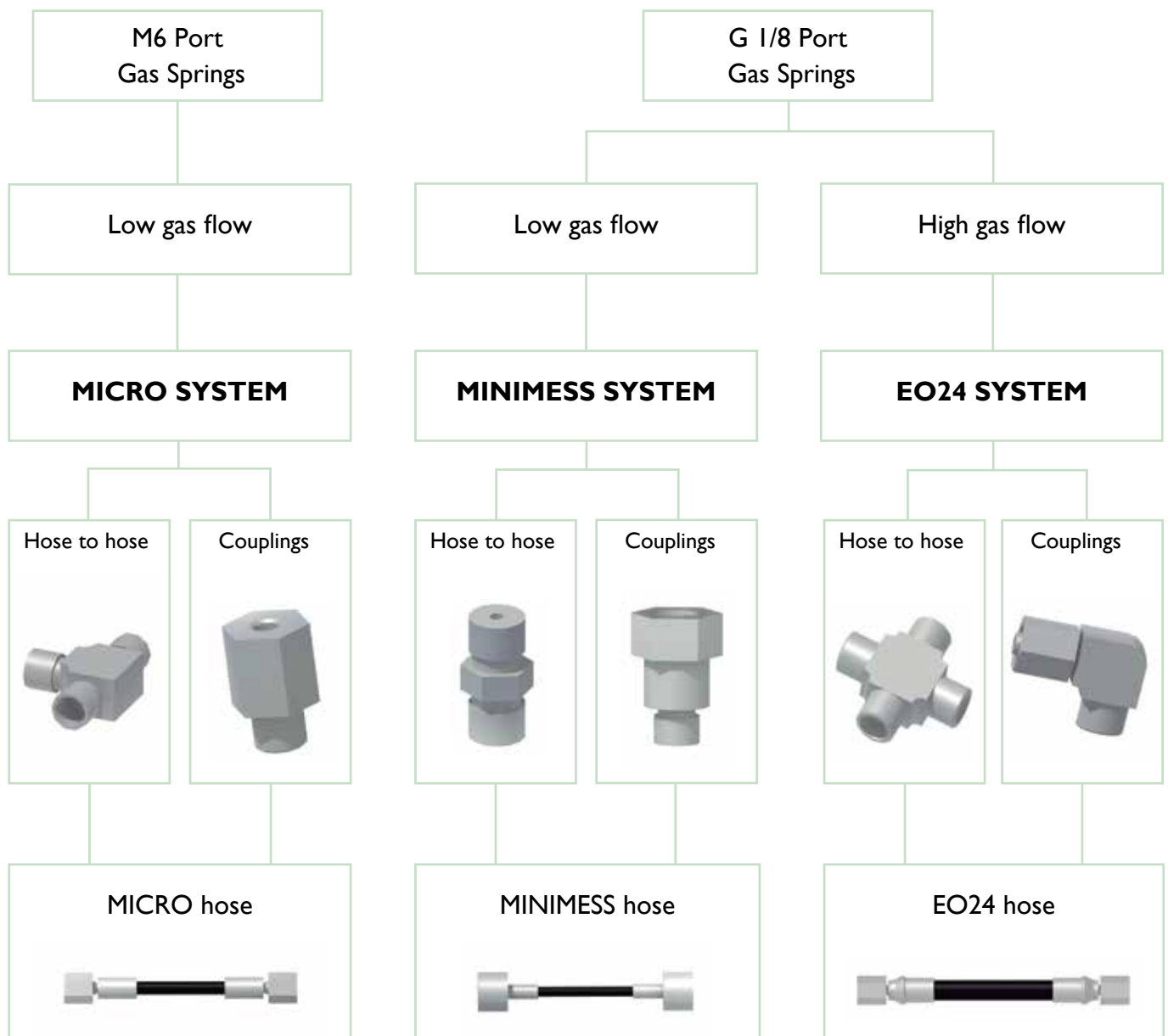

The possibility of being or not connecting, as well as the connection type (M6 or G1/8") of each gas spring model is indicated in the specification sheet of each model.



## Safety standards

When looking for safety and optimum performance life in a hose system creation, it is important to consider the following points:

- Before converting gas springs from self-contained to linked mode and remove the valve, **ensure the gas spring is completely discharged.**
- Place the control panel in the tool where it will be protected from mechanical damage, and on a higher level than the gas springs to minimize loss of lubrication oil when discharging the gas.
- Use only nitrogen ( $N_2$ ) gas. The use of other types of gas can result in personal injury or failure of the gas spring/control panel.
- Do not exceed the maximum pressures and temperatures given for the hoses and gas springs.
- All valves on the control panel should be closed during operation.
- All gas springs hosed together should be of the same size and model.

**NITROGAS provides training courses on piping gas springs systems.**

## Mounting arrangement

Open line

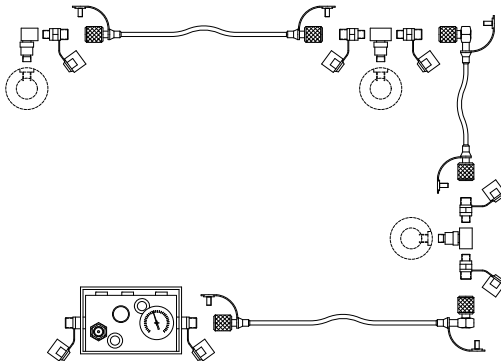

Closed ring line

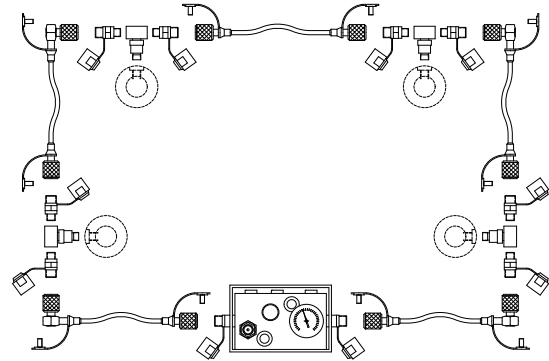

Group series

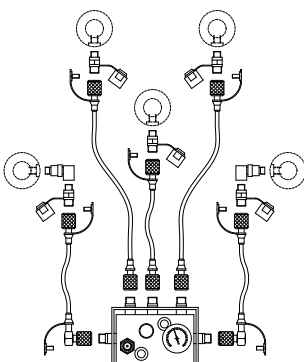

Group series  
with distribution block

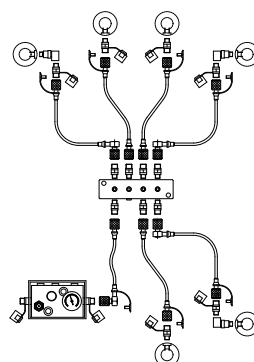

Group series  
with multiple control panel

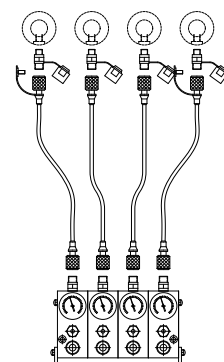

## Specification for installation

Follow the instruction below to ensure functionality and maximum service life for hose connection. Ensure that all hoses and adaptors are perfectly clean before assembling.

1. The hose length must provide a certain amount of play.
2. Do not twist the longitudinal marking during assembly.

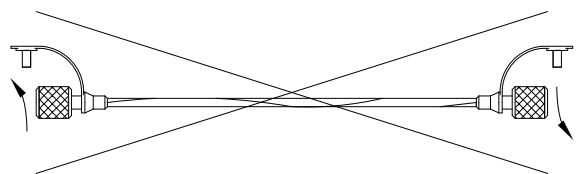
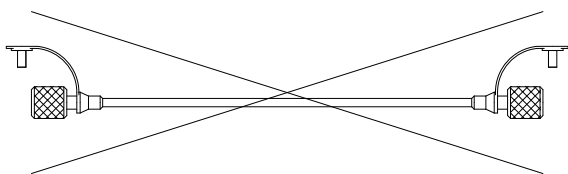

3. Choose the appropriate fittings to avoid sharp bends in the hose.
4. Any bends in the hose must have at least the recommended minimum radius.

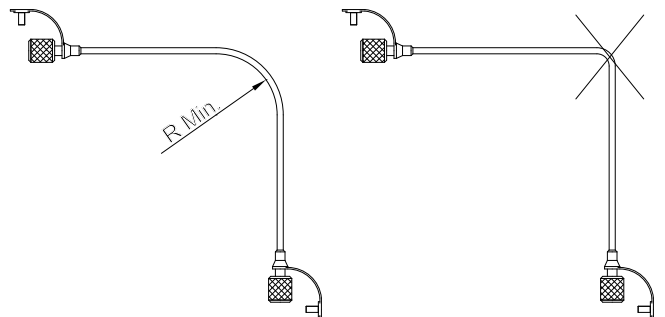
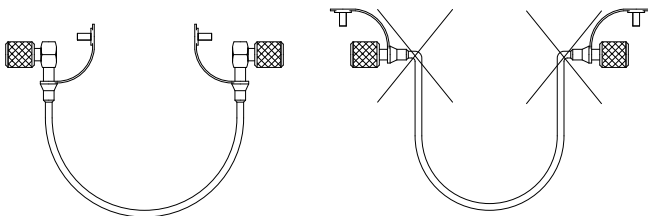

5. Fix the hose correctly to avoid mechanical damage. We recommend using RM-108 clips to fix the hose.
6. The hose must have at least a minimum drop length.

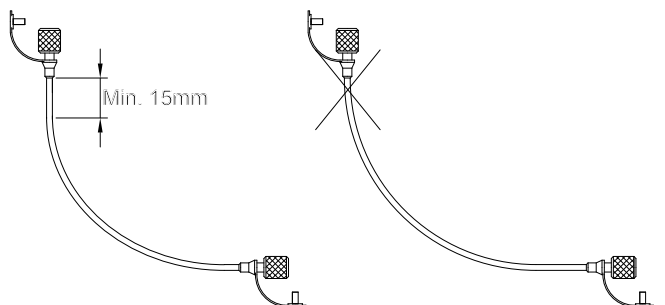
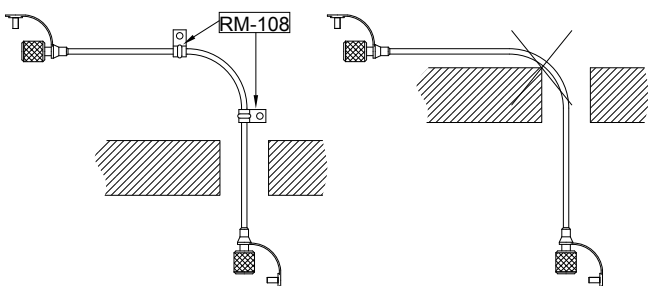



## Micro System

### Hoses

Basic information	
Material	Polyamide
Dimension	External Ø 4.9 mm Internal Ø 2 mm
Min. bend radius	20 mm
Max. working pressure	630 bar
Min. burst pressure	1900 bar
Operating temperature	-40°C / +100°C
Minimum length	200 mm

LKI

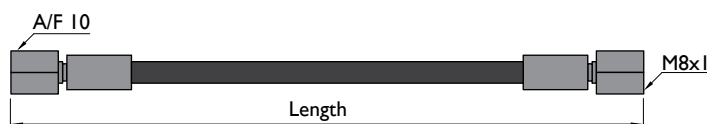

Ordering example: LKI-Length in mm

4 x LKI-750

## Micro System

### Terminals

#### TERM-LK

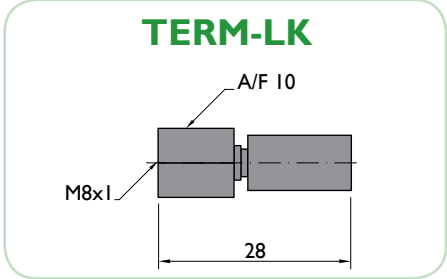

### Hose to hose

#### RC-605

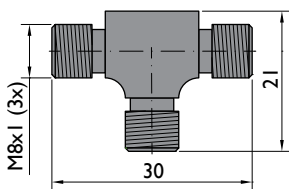

#### RC-606

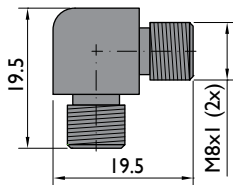

#### RC-607

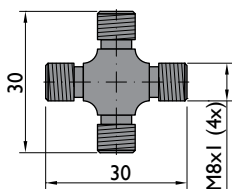

#### RM-609

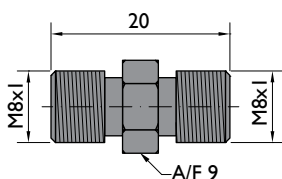

### Couplings

#### RM-601

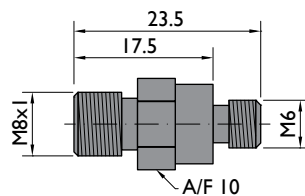

#### RM-602

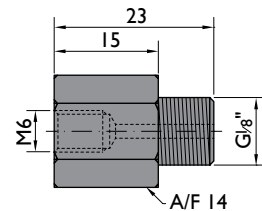

#### RM-603

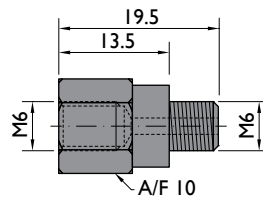

#### RM-604

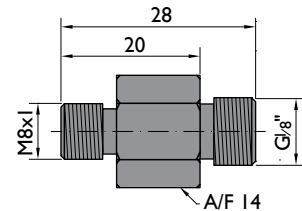

#### RM-605

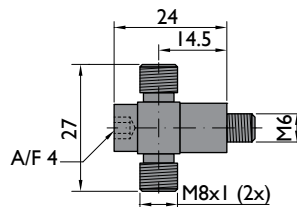

#### RM-606

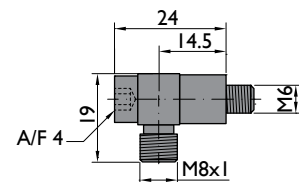

## EO24 System

### Hoses

Basic information	
Material	Polyamide
Dimension	External Ø 10.7 mm Internal Ø 4.8 mm
Min. bend radius	40 mm
Max. working pressure	345 bar
Min. burst pressure	1380 bar
Operating temperature	-40°C / +100°C
Minimum length	300 mm

**LD1**

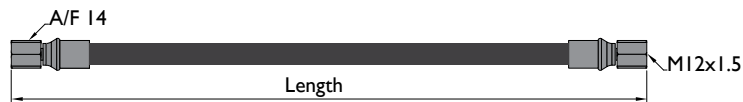

**LD2**

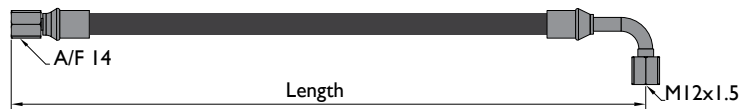

**LD3**

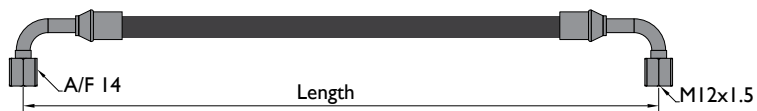

**LD4**

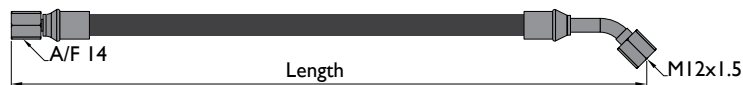

**LD5**



**LD6**

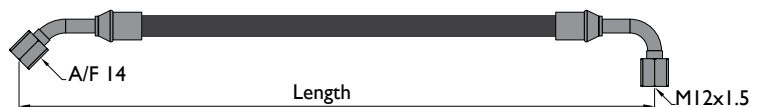

Ordering example: LD(1,2,3,4,5,6)-Length in mm

4 x LD1-750

## EO24 System

### Terminals

#### TERM-LDR

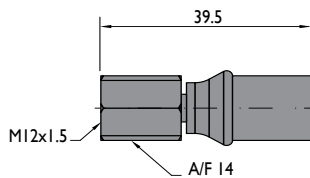

#### TERM-LDC

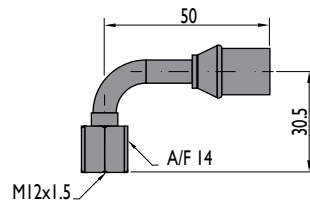

#### TERM-LDA

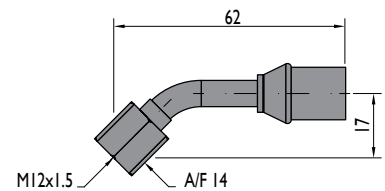

### Hose to hose

#### RC-505

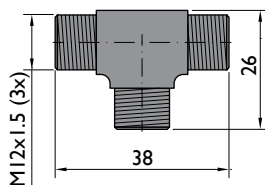

#### RC-506

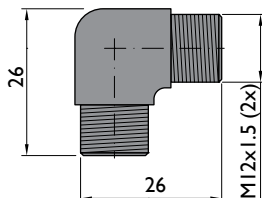

#### RC-507

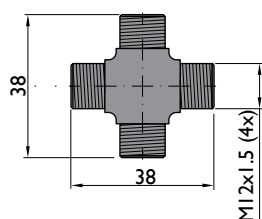

#### RM-509

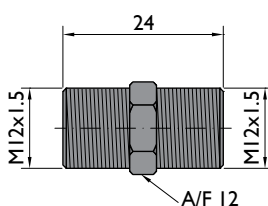

### Couplings

#### RM-501

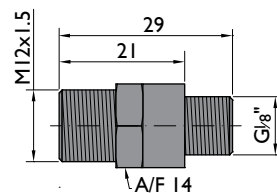

#### RM-503

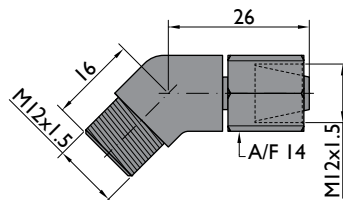

#### RM-504

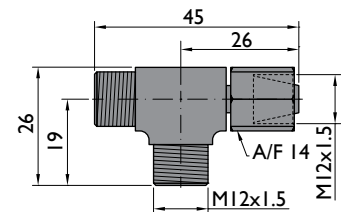

#### RM-505

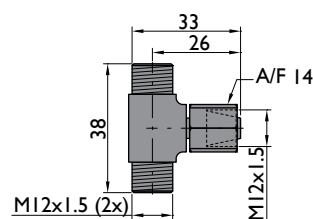

#### RM-506

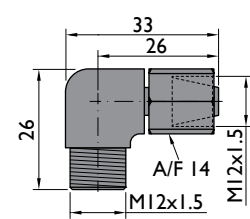

## Minimess System

### Hoses

Basic information	
Material	Polyamide
Dimension	External Ø 4.9 mm Internal Ø 2 mm
Min. bend radius	20 mm
Max. working pressure	630 bar
Min. burst pressure	1900 bar
Operating temperature	-40°C / +100°C
Minimum length	200 mm

LM1

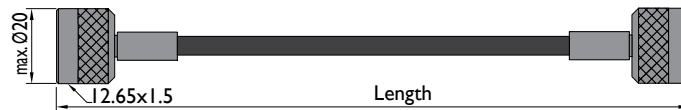

LM2

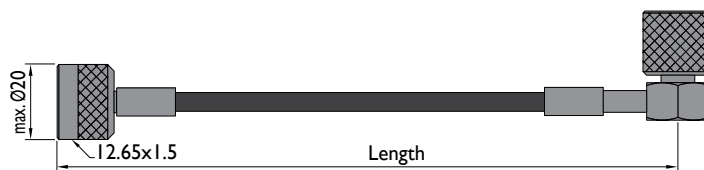

LM3

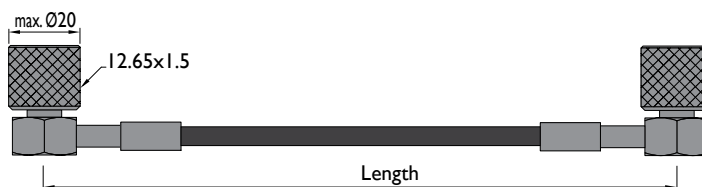

Ordering example: LM(1,2,3)-Length in mm

4 x LM1-750

## Minimess System

### Terminals

#### TERM-RECTO

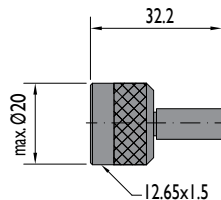

#### TERM-CODO

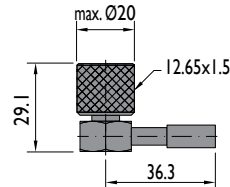

### Hose to hose

#### RM-109

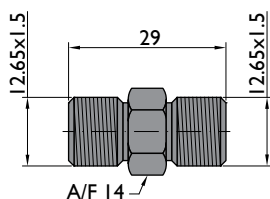

### Couplings

#### RM-101\*

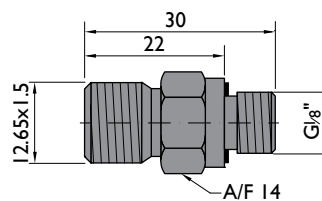

#### RM-20I

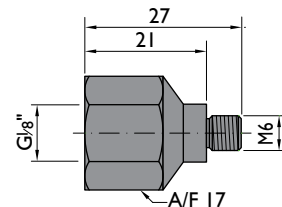

#### RM-103

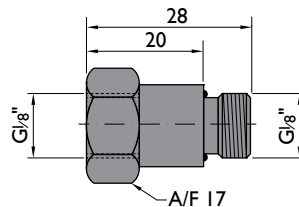

#### RM-105

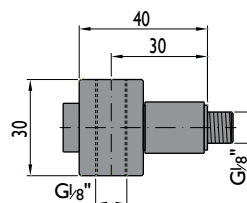

#### RM-106

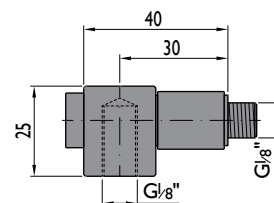

#### MP-125

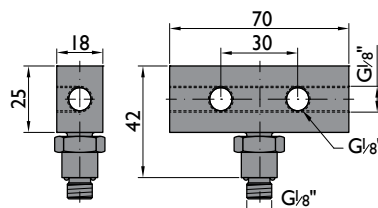

\* Includes a non-return valve to keep the pressure on each gas spring individually when removing the hoses.

## Control panels

### PCM-8

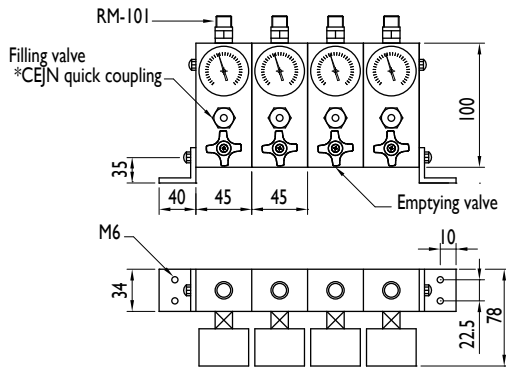

Minimess

### PC-I

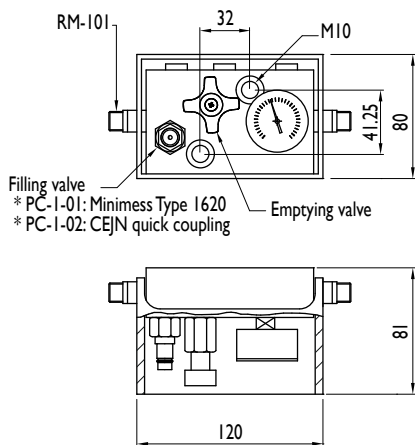

Minimess

### PC-2

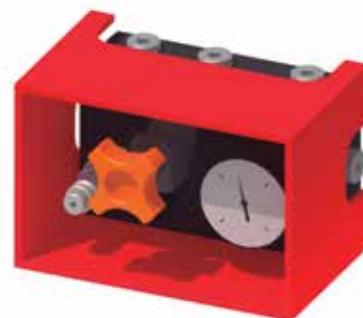
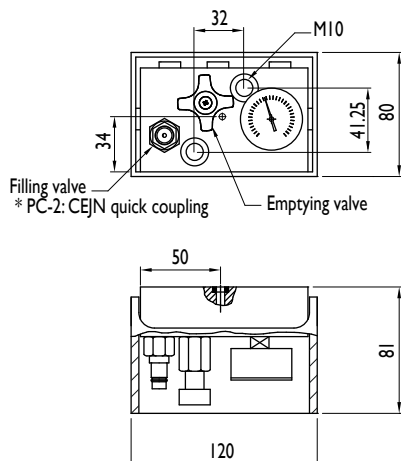

Minimess

## Control panels

### PC-4

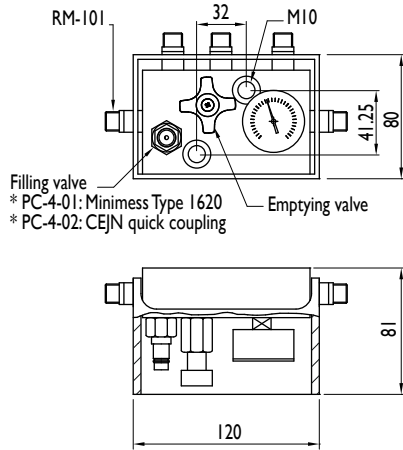

Minimes

### PC-5

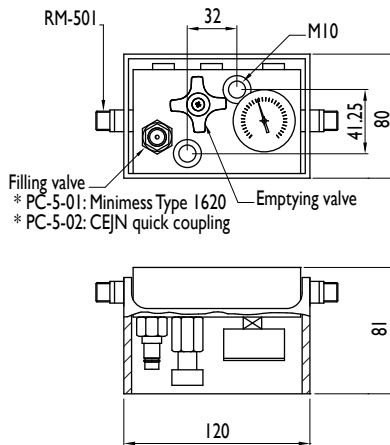

EO24

### PC-6

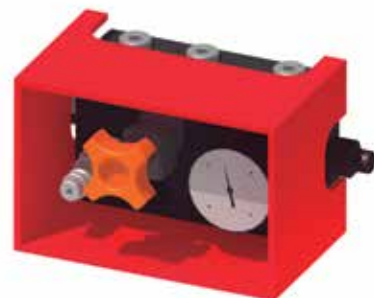
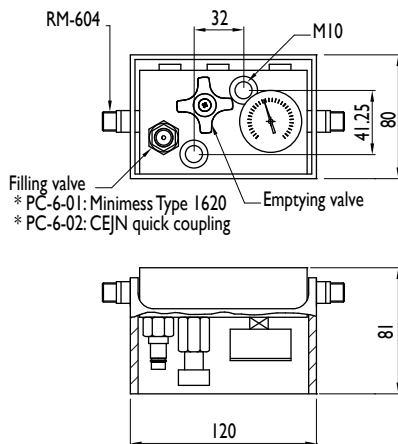

Micro





## Distribution blocks

Distribution blocks simplify piping to multiple cylinders with a uniform system pressure. NITROGAS offers distribution blocks with M6 and G 1/8 connections.

### RDM-4

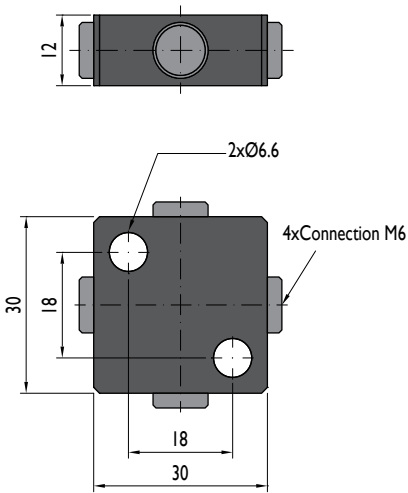

### RD-4

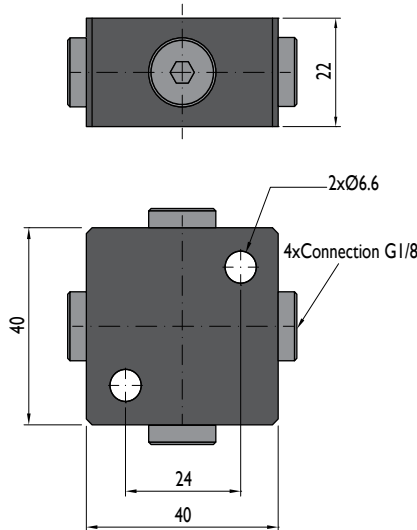

### RDH-6

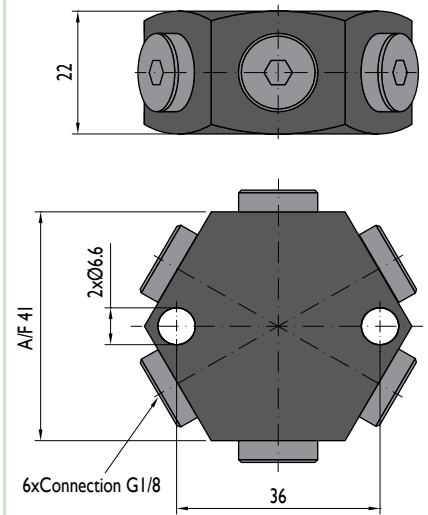

### RD-6

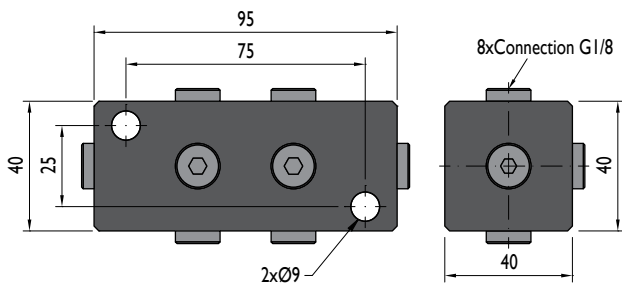

### RD-9

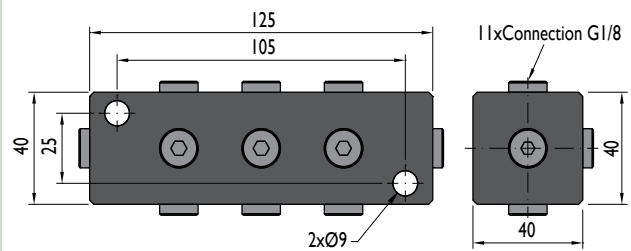

### RD-12

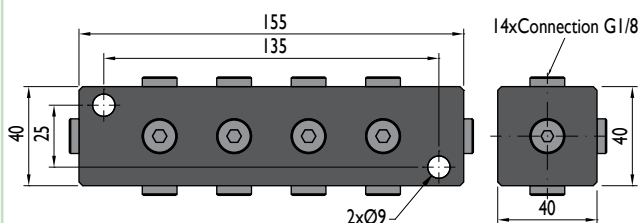

### RD-xx

Number of connections by request

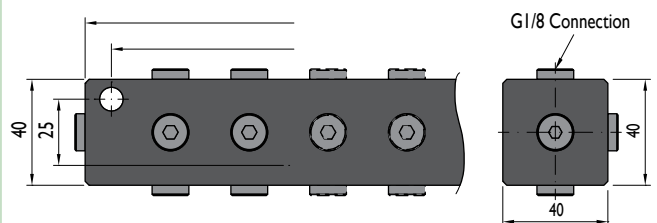

## Charging equipment

**EC-100**



Loading equipment

**CP-218 1/8**



Pressure tester regulator

**ED-150**



Hose for loading equipment

**RP-106**



Pressure regulator

### Quick coupling

Female



Quick coupling female adapter

Port	Reference
G1/4"	QCF-1/4

### Quick coupling

Male



Quick coupling male adapter

Port	Reference
G1/4"	QCM-1/4
G1/8"	QCM-1/8

**DF-01**



Leak detector spray

**MP-122**



Pressure gauge

Dimensions	
Diameter	40 mm
Width	27 mm
Port	G1/8 "



## Booster

### MP30

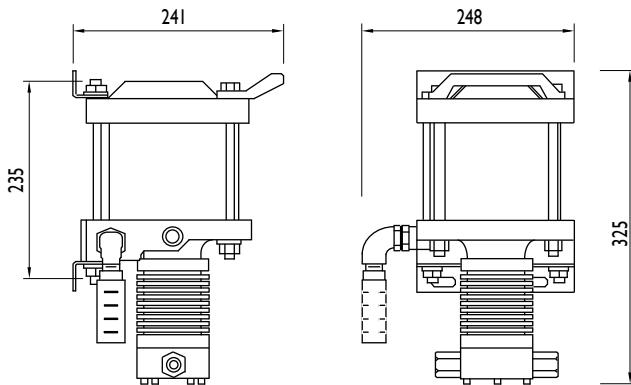

#### Basic information

Pressure medium	N <sub>2</sub>
Drive compressed air	3-10 bar
Stall pressure formula	30x Air pressure
Max. outlet pressure	300 bar

#### Characteristics

Pressure multiplier increases gas pressure for a maximum utilization of the bottles

### CC-MP30

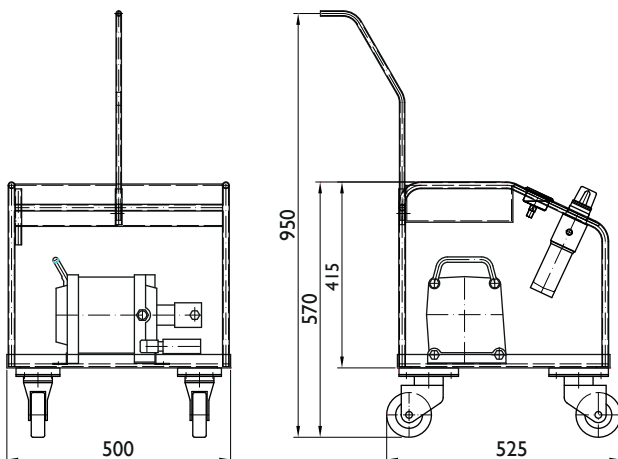

#### Basic information

Pressure medium	N <sub>2</sub>
Drive compressed air	3-10 bar
Stall pressure formula	30x Air pressure
Max. outlet pressure	300 bar

#### Characteristics

Compact pressure multiplier consisting of a cart, a pressure multiplier and manometers for measuring bottle's pressure and charging pressure

Easily transportable

## Booster

### CC-6B-MP30

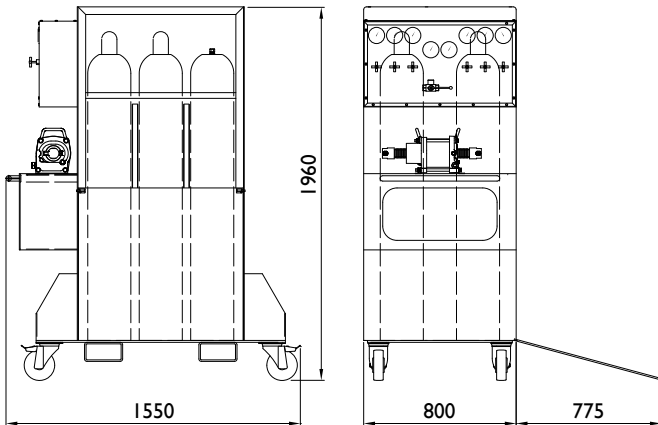

#### Basic information

Pressure medium	N <sub>2</sub>
Drive compressed air	3-10 bar
Stall pressure formula	30x Air pressure
Max. outlet pressure	200 bar

#### Characteristics

Nitrogen charging cart with pressure multiplier, appropriate for charging manifold plates with large nitrogen volumes (6 bottles capacity)

With security mechanism: The multiplier stops if the load pressure reaches 200 bar

Easily transportable

### P-MP30

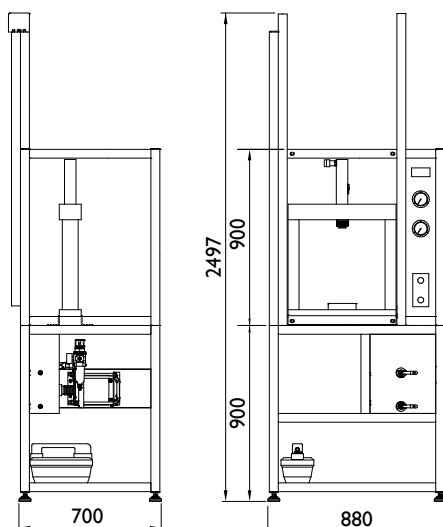

#### Basic information

Pressure medium	N <sub>2</sub>
Drive compressed air	3-10 bar
Stall pressure formula	30x Air pressure
Max. outlet pressure	300 bar

#### Characteristics

Press with integrated pressure multiplier for charging and checking gas springs

Load protected cab

Includes test press P-I 17



## Test press

### P-117

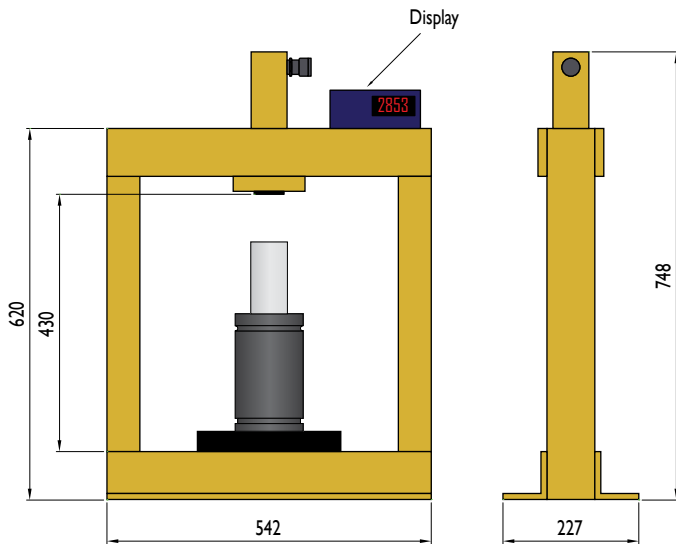

#### Basic information

Capacity	Maximum force	10 ton
	Maximum stroke	156 mm
Pusher	Manual/Pneumatic	
Display	Digital	

### P-118

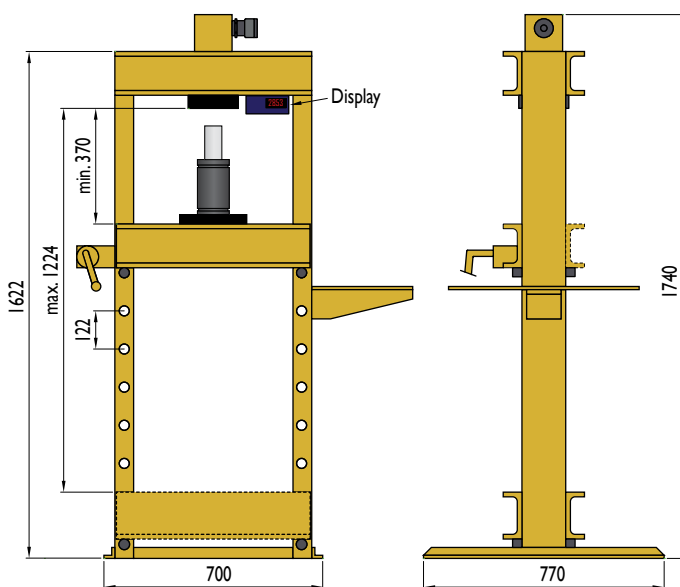

#### Basic information

Capacity	Maximum force	25 ton
	Maximum stroke	158 mm
Pusher	Manual/Pneumatic	
Display	Digital	

## Hose crimping press

### PLM-01

Use hose crimping press to create permanent hose assemblies.



#### Basic information

Dimensions	Basic information	
	Length	260 mm
Width	200 mm	
Height	145 mm	
Weight	19 kg	
	Number of jaws	8
	Max. working pressure	48 MPa
	Stroke	38 mm

Using different dies enables creating hoses of the three different systems.

System	Crimping
Minimes	G-PLM
EO24	G-PLD
Micro	G-PLK



## Tools

### Small Spring Plunger Key

Order No.	d <sub>i</sub>	Order No.	d <sub>i</sub>	Order No.	d <sub>i</sub>
DE-3-R	M3	DE-6-R	M6	DE-12-R	M12
DE-4-R	M4	DE-8-R	M8	DE-16-R	M16
DE-5-R	M5	DE-10-R	M10	DE-20-R	M20

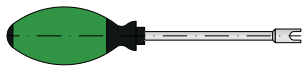

### Big Spring Plunger Key

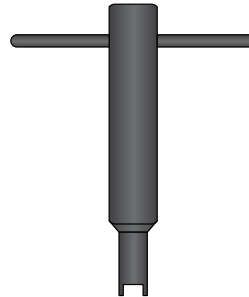

Order No.	d <sub>i</sub>
DE-24-R	M24

### ER-01 (M6)

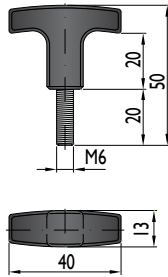

Extractor

### ER-02 (M8)

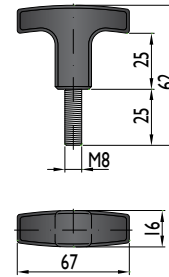

Extractor

### BD-M6-113

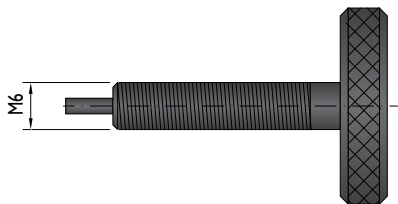

M6 unload nozzle

### BD-1/8-114

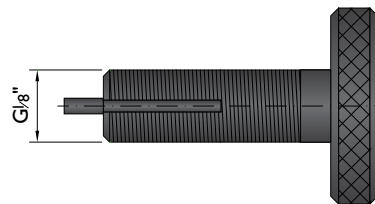

Gas 1/8 unload nozzle

### T-116

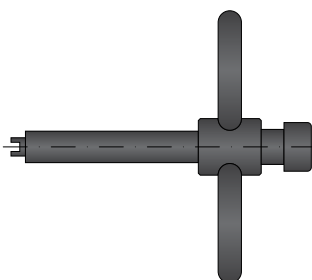

Valve extraction key

### DYNAMOMETRIC TOOL



Order No.	Valve
LLAVE-DIN-VALV-M6	V-M6 42970
LLAVE -DIN-VAL	VN-116

## Support plates

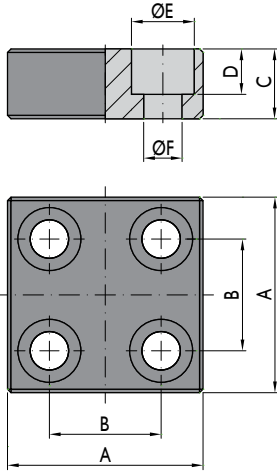

	A mm	B mm	C mm	D mm	E mm	F mm
SPC-150	40	21	15	10	15	9
SPC-250	40	21	15	10	15	9
SPC-500	40	21	15	10	15	9
SPC-750	56	32	20	13	18	11
SPC-1500	56	32	20	13	18	11
SPC-3000	90	67	20	13	18	11
SPC-5000	90	67	20	13	18	11
SPC-7500	140	110	20	13	18	11
SPC-10000	140	110	20	13	18	11

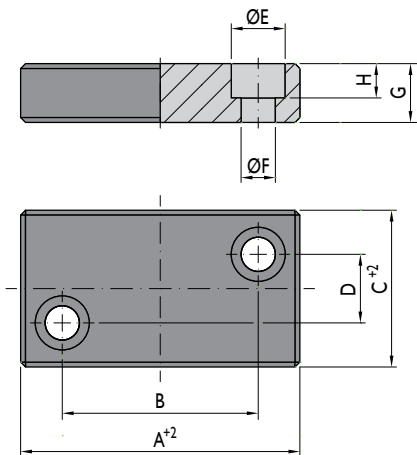

	A mm	B mm	C mm	D mm	E mm	F mm	G mm	H mm
SPV-150	50	32	25	8	11	7	12	7
SPV-250	50	32	25	8	11	7	12	7
SPV-500	55	40	30	14	11	7	12	7
SPV-750	70	48	35	14	15	9	15	9
SPV-1500	75	56	50	30	15	9	15	9
SPV-3000	85	66	60	40	15	9	15	9
SPV-5000	100	72	80	56	18	11	20	11
SPV-7500	110	85	100	75	18	11	20	11
SPV-10000	130	100	110	80	18	11	20	11

## Identification plates

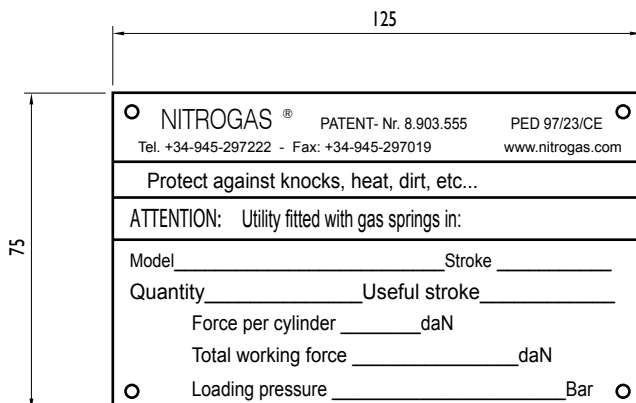

NITROGAS recommends identifying tools containing high pressure nitrogen gas springs to ensure the proper handling of the gas springs.

Reference	Language
PI-119-1	Spanish
PI-119-2	English
PI-119-3	German
PI-119-4	French



























# Products

## Gas Springs



A wide range of high quality gas springs and accessories to use in press dies or injection moulds.



## Controllable gas springs (CPC)

CPC gas spring allows a controlled stop at the end of rod stroke. This stop is highly reliable, always performing at the same position and with a 100% guarantee.



## Cam units

Designed to use the power of the press to punch, blend or form in different directions from the direction of the press tool.



## Solutions for the storage tools

Designed to replace conventional distance blocks.

### CS gas springs: Die storage cylinder

- Do not work during the production

### SG gas springs: Stocking cylinder

- Work as a standard gas spring
- ISO standard dimensions but longer life than standard gas springs

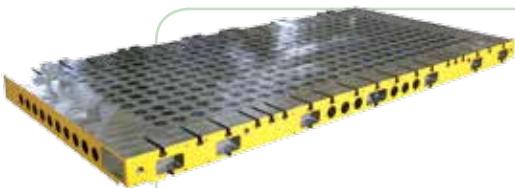

## Manifold plates

Designed to replace the hosing connection of gas springs by threading the gas springs directly on the plate. The system allows a more flexible distribution of the gas springs, reduces the leaking points and guarantees that all the gas springs have the same pressure.



## Guide rail lifters

Designed to replace and simplify the guide pillar, gas spring and retainer screw structure when raising the sheet or the workpiece.

# Contacts



CAD files of the product can be downloaded FREE from our website:  
<http://www.nitrogas.com/es/Downloads.aspx>



## Commercial

 [comercial@nitrogas.com](mailto:comercial@nitrogas.com)



## Training

 [training@nitrogas.com](mailto:training@nitrogas.com)



## Engineering

 [engineering@nitrogas.com](mailto:engineering@nitrogas.com)



## Maintenance

 [maintenance@nitrogas.com](mailto:maintenance@nitrogas.com)



## Contact hours

NITROGAS offers 24 hs contact service.

# NITROGAS



[nitrogas@nitrogas.com](mailto:nitrogas@nitrogas.com)  
[www.nitrogas.com](http://www.nitrogas.com)

# NITROGAS